

ELECTRICAL ENGINEERING TEXTS

**PRINCIPLES OF
ALTERNATING CURRENT MACHINERY**

ELECTRICAL ENGINEERING TEXTS

A series of textbooks outlined by a committee of well-known electrical engineers of which Harry E. Clifford, Gordon McKay Professor of Electrical Engineering, Harvard University, is Chairman and Consulting Editor.

Laws—

ELECTRICAL MEASUREMENTS

Lawrence—

PRINCIPLES OF ALTERNATING-CURRENT MACHINERY

Lawrence—

PRINCIPLES OF ALTERNATING CURRENTS

Langsdorf—

PRINCIPLES OF DIRECT-CURRENT MACHINES

Daves—

COURSE IN ELECTRICAL ENGINEERING

Vol. I.—Direct Currents. 2nd Edition.

Vol. II.—Alternating Currents

Daves—

**INDUSTRIAL ELECTRICITY—PART I
INDUSTRIAL ELECTRICITY—PART II**

ELECTRICAL ENGINEERING TEXTS

PRINCIPLES
OF
ALTERNATING CURRENT
MACHINERY

BY

RALPH R. LAWRENCE

ASSOCIATE PROFESSOR OF ELECTRICAL ENGINEERING OF THE MASSACHUSETTS
INSTITUTE OF TECHNOLOGY; MEMBER OF THE AMERICAN
INSTITUTE OF ELECTRICAL ENGINEERS, ETC.

SECOND EDITION
TENTH IMPRESSION

McGRAW-HILL BOOK COMPANY, Inc.
NEW YORK: 370 SEVENTH AVENUE
LONDON: 6 & 8 BOUVERIE ST., E. C. 4
1921

COPYRIGHT 1916, 1920, BY THE
McGraw-Hill Book Company, Inc.

PRINTED IN THE UNITED STATES OF AMERICA

THE MAPLE PRESS - YORK PA

PREFACE TO THE SECOND EDITION

The use by the author of this book in class since its publication in 1916, as well as constructive criticism received from fellow teachers, has indicated minor changes in the text which would add to its clearness. These changes have been incorporated in the second edition. Such typographical errors as unavoidably appeared in the first edition have been corrected. Chapter VIII, concerning the transient short-circuit conditions in an alternator, has been rewritten and expanded to bring out more clearly what actually takes place. A small amount of new material has been added for the sake of completeness.

Although some criticism was offered to the first edition of the book on the ground that it contained no problems, the addition of problems seemed unnecessary as a much more complete set than could be included in the book was already published under the title "Problems in Alternating Current Machinery" by Professor W. V. Lyon. These problems were compiled by Professor Lyon for use in connection with the course in Alternating Current Machinery at the Massachusetts Institute of Technology for which the author's book was written.

RALPH R. LAWRENCE.

CAMBRIDGE, MASSACHUSETTS,
April, 1920.

PREFACE TO THE FIRST EDITION

This book deals with the principles underlying the construction and operation of alternating-current machinery. It is in no sense a book on design. It is the result of a number of years' experience in teaching the subject of Alternating-current Machinery to senior students in Electrical Engineering and has been developed from a set of printed and neostyled notes used for several years by the author at the Massachusetts Institute of Technology.

The transformer is the simplest piece of alternating-current apparatus and logically perhaps should be considered first in discussing the principles of alternating-current machinery. Experience has shown, however, that students just beginning the subject grasp the principles of the alternator more readily than those of the transformer. For this reason the alternator is taken up first.

No attempt has been made to treat all types of alternating-current machines, only the most important being considered. Certain types have been developed in considerable detail where such development seemed to bring out important principles, while other types have been considered only briefly or omitted altogether. No new methods have been used, but it is believed that bringing together material which has been much scattered and making it available for students is sufficient reason for the publication of the book.

Mathematical and analytical treatment of the subject has been freely employed where such treatment offered any advantage. The symbolic notation has been used throughout the book.

The author wishes to express his sincere thanks to Professor W. V. Lyon of the Massachusetts Institute of Technology for many suggestions and especially to Professor H. E. Clifford, Gordon McKay Professor of Electrical Engineering at Harvard University and the Massachusetts Institute of Technology, who critically read the original manuscript and offered many suggestions. The author also wishes to express his thanks to Mr. N. S. Marston for his care in reading the proof, and to the Crocker-Wheeler Company, the General Electric Company and the Westinghouse Electric and Manufacturing Company who furnished photographs from which the drawings of machines were prepared.

RALPH R. LAWRENCE.

MASSACHUSETTS INSTITUTE OF TECHNOLOGY,
BOSTON, *September, 1916.*

NOTATION

In general the notation recommended by the American Institute of Electrical Engineers has been followed. Throughout the book E has been used to denote a voltage generated or induced. V has been reserved for a terminal voltage which could be measured by a voltmeter. V differs from E by the impedance drop in the machine or part of the machine considered. The line which is often used over quantities in equations to indicate that they are to be considered in a vector sense has been omitted in all but one or two cases. Most of the equations in the book are to be considered in a vector sense. Those which are purely algebraic are readily distinguished. In general the letters used have the following significance:

- A = Armature Reaction, generally expressed in ampere turns per pole.
- A' = Fictitious Armature Reaction, including real armature reaction and the effect of the leakage reactance, generally expressed in ampere turns per pole.
- a = Ratio of Transformation.
- \mathfrak{B} = Flux Density.
- b = Susceptance.
- E = Induced or Generated Voltage.
- E_1 = Primary Induced Voltage of a transformer or of an induction motor.
- E_2 = Secondary Induced Voltage of a transformer or of an induction motor.
- F = Impressed Field of a synchronous generator or motor, generally expressed in ampere turns per pole.
- \mathfrak{F} = Magnetomotive Force.
- f = Frequency.
- \mathcal{F} = Function.
- g = Conductance.
- I = Current.
- I_ϕ = Magnetizing Current of a transformer or of an induction motor.
- I_{h+c} = Core-loss Current of a transformer or of an induction motor.
- I_n = Exciting Current of a transformer or of an induction motor.
- I'_1 = Load Component of Primary Current of a transformer or of an induction motor.
- I_1 = Primary Current of a transformer or of an induction motor.
- I_2 = Secondary Current of a transformer or of an induction motor.
- \mathfrak{J} = Moment of Inertia.
- j = Operating Factor which rotates a vector anti-clockwise through ninety degrees.
- k_b = Breadth Factor.
- k_p = Pitch Factor.
- N = Turns.
- n = Speed, or Number of Phases.

- P = Power.
 p = Number of poles.
 $p.f.$ = Power Factor.
 R = Resultant Field of a Synchronous generator or motor, generally expressed in ampere turns per pole.
 \mathcal{R} = Reluctance.
 r = Resistance.
 r_1 = Primary Resistance of a transformer or of an induction motor.
 r_2 = Secondary Resistance of a transformer or of an induction motor.
 r_e = Effective Resistance or Equivalent Resistance of a transformer.
 s = Slip or Number of Slots per Phase.
 T = Torque.
 V = Terminal Voltage;
 V_1 = Primary Terminal Voltage of a transformer or of an induction motor.
 V_2 = Secondary Terminal Voltage of a transformer.
 x = Reactance.
 x_a = Leakage Reactance of a generator or motor.
 x_1 = Primary Reactance of a transformer or of an induction motor.
 x_2 = Secondary Reactance of a transformer or of an induction motor.
 x_e = Equivalent Reactance of a transformer.
 x_s = Synchronous Reactance.
 y = Admittance.
 Z = Number of Inductors.
 z = Impedance.
 z_s = Synchronous Impedance.
 α = Angular Acceleration or a Phase Angle.
 η = Efficiency or Hysteresis Constant.
 θ = Angle of Lag.
 ρ = Coil Pitch.
 Σ = Summation.
 φ = Flux.
 ω = Angular Velocity or $2\pi f$.

Where the letters given in the preceding table are used with other significance than as just indicated, it is so stated in the text. Where other letters are used, their meaning is stated in the text.

CONTENTS

	PAGE
PREFACE.....	v
TABLE OF SYMBOLS.....	vi

SYNCHRONOUS GENERATORS

CHAPTER I

Types of Alternators—Frequency—Armature Cores—Field Cores— Armature Insulation—Field Insulation—Cooling—Filtering or Washing Cooling Air—Permissible Temperatures for Different Types of Insulation.	1
---	---

CHAPTER II

Induced Electromotive Force—Phase Relation Between a Flux and the Electromotive Force It Induces—Shape of Flux and Electro- motive-force Waves when Coil Sides are 180 Electrical Degrees Apart—Calculation of the Electromotive Force Induced in a Coil when the Coil Sides are not 180 Electrical Degrees Apart.	20
--	----

CHAPTER III

Open- and Closed-circuit Windings—Bar and Coil Windings—Con- centrated and Distributed Windings—Whole- and Half-coiled Windings—Spiral, Lap and Wave Windings—Single- and Poly- phase Windings—Pole Pitch—Coil Pitch—Phase Spread—Breadth Factor—Harmonics—Pitch Factor—Effect of Pitch on Harmonics— Effect on Wave Form of Distributing a Winding—Harmonics in Three-phase Generators.	27
--	----

CHAPTER IV

Rating—Regulation—Magnetomotive Forces and Fluxes Concerned in the Operation of an Alternator—Armature Reaction—Armature Reaction of an Alternator with Non-salient Poles—Armature Reac- tion of an Alternator with Salient Poles—Armature Leakage Reac- tance—Equivalent Leakage Reactance—Effective Resistance— Factors which Influence the Effect and Magnitude of Armature Reaction, Armature Reactance and Effective Resistance—Con- ditions for Best Regulation.	51
---	----

CHAPTER V

	PAGE
Vector Diagram of an Alternator with Non-salient Poles—Vector Diagram Applied as an Approximation to an Alternator with Salient Poles—Calculation of the Regulation of an Alternator from Vector Diagram—Synchronous-impedance and Magnetomotive-force Methods for Determining Regulation—Data Necessary for the Application of the Synchronous-impedance and the Magnetomotive-force Methods—Examples of the Calculation of Regulation by the Synchronous-impedance and Magnetomotive-force Methods—Potier Method—American Institute Method—Example of the Calculation of Regulation by the American Institute Method—Value of A' of the Magnetomotive-force Method for Normal Saturation—Example of the Calculation of Regulation by the Magnetomotive-force Method Using the Value of A' Obtained from a Zero-power-factor Test—Blondel Two-reaction Method for Determining Regulation of an Alternator—Example of Calculation of Regulation by the Two-reaction Method.	84

CHAPTER VI

Short-circuit Method for Determining Leakage Reactance—Zero-power-factor Method for Determining Leakage Reactance—Potier Triangle Method for Determining Reactance—Determination of Leakage Reactance from Measurements made with Field Structure Removed—Determination of Effective Resistance with Field Structure Removed.	118
---	-----

CHAPTER VII

Losses—Measurement of the Losses by the Use of a Motor—Measurement of Effective Resistance—Retardation Method of Determining the Losses—Efficiency.	123
---	-----

CHAPTER VIII

Short-circuit Current.....	133
----------------------------	-----

CHAPTER IX

Conditions and Methods for Making Heating Tests of Alternators without Applying Load.	136
---	-----

CHAPTER X

Calculation of Ohmic Resistance, Armature Leakage Reactance, Armature Reaction, Air-gap Flux per Pole, Average Flux Density in the Air Gap and Average Apparent Flux Density in the Armature Teeth from the Dimensions of an Alternator—Calculation of Leakage Reactance and Armature Reaction from an Open-circuit Saturation Curve and a Saturation Curve for Full-load Current at Zero Power Factor—Calculation of Equivalent-leakage Flux per	142
---	-----

Unit Length of Embedded Inductor and Effective Resistance from Test Data—Calculation of Regulation, Field Excitation and Efficiency for Full-load Kv-a. at 0.8 Power Factor by the A. I. E. E. Method.

STATIC TRANSFORMERS

CHAPTER XI

Transformer—Types of Transformers—Cores—Windings—Insulation 151
—Terminals—Cooling—Oil—Breathers.

CHAPTER XII

Induced Voltage—Transformer on Open Circuit—Reactance Coil. 164

CHAPTER XIII

Determination of the Shape of the Flux Curve which Corresponds to a 169
Given Electromotive-force Curve—Determination of the Electro-
motive-force Curve from the Flux Curve—Determination of the
Magnetizing Current and the Current Supplying the Hysteresis
Loss from the Hysteresis Curve and the Curve of Induced Voltage
—Current Rushes.

CHAPTER XIV

Fluxes Concerned in the Operation of a Transformer and No-load 179
Vector Diagram—Ratio of Transformation—Reaction of Secondary
Current—Reduction Factors—Relative Values of Resistances—
Relative Values of Reactances—Calculation of Leakage Reactance
—Load Vector Diagram—Analysis of Vector Diagram—Solution of
Vector Diagram and Calculation of Regulation.

CHAPTER XV

True Equivalent Circuit of a Transformer—Graphical Representation of 195
the Approximate Equivalent Circuit—Calculation of Regulation
from the Approximate Equivalent Circuit.

CHAPTER XVI

Losses in a Transformer—Eddy-current Loss—Hysteresis Loss— 200
Screening Effect of Eddy Currents—Efficiency—All-day Efficiency.

CHAPTER XVII

Measurement of Core Loss—Separation of Eddy-current and Hystere- 213
sis Losses—Measurement of Equivalent Resistance—Measurement
of Equivalent Reactance, Short-circuit Method—Measurement of
Equivalent Reactance, Highly-inductive-load Method—Opposition
Method of Testing Transformers.

CHAPTER XVIII

	PAGE
Current Transformer—Potential Transformer—Constant-current Transformer—Auto-transformer—Induction Regulation.	222

CHAPTER XIX

Transformers with Independently Loaded Secondaries; Parallel Operation of Single-phase Transformers.	241
--	-----

CHAPTER XX

Transformer Connections for Three-phase Circuits Using Three Transformers—Three-phase Transformation with Two Transformers—Three- to Four-phase Transformation and Vice Versa—Three- to Six-phase Transformation—Two- or Four-phase to Six-phase Transformation—Three- to Twelve-phase Transformation.	252
--	-----

CHAPTER XXI

Three-phase Transformers—Third Harmonics in the Exciting Currents and in the Induced Voltages of Y- and Δ -connected Transformers—Advantages and Disadvantages of Three-phase Transformers—Parallel Operation of Three-phase Transformers or Three-phase Groups of Single-phase Transformers—V- and Δ -connected Transformers in Parallel.	272
--	-----

CHAPTER XXII

Ratio of Transformation, Flux and Flux Density—Primary and Secondary Leakage Reactances, Equivalent Reactance, Primary and Secondary Resistances Calculated from the Dimensions of a Transformer—Core Loss—Component of No-load Current Supplying Core Loss, Magnetizing Current and No-load Current Calculated from Dimensions of Transformer and Core Loss and Magnetization Curves—Equivalent Resistance and Equivalent Reactance from Test Data—Calculated Regulation and Efficiency.	288
---	-----

SYNCHRONOUS MOTORS

CHAPTER XXIII

Construction—General Characteristics—Power Factor—V-curves—Methods of Starting—Explanation of the Operation of a Synchronous Motor.	297
---	-----

CHAPTER XXI

Vector Diagram—Magnetomotive-force and Synchronous-impedance Diagrams—Change in Normal Excitation with Change of Load—Effect of Change in Load and Field Excitation.	304
--	-----

CHAPTER XXV

- | | PAGE |
|--|------|
| Maximum and Minimum Motor Excitation for Fixed Motor Power and Fixed Impressed Voltage—Maximum Motor Power with Fixed E_a' , V , r_s and x_s ; Maximum possible Motor Excitation with Fixed Impressed Voltage and Fixed Resistance and Reactance—Maximum Motor Activity with Fixed Impressed Voltage and Fixed Reactance and Resistance. | 309 |

CHAPTER XXVI

- | | |
|---|-----|
| Hunting—Damping—Stability—Methods of Starting Synchronous Motors. | 314 |
|---|-----|

CHAPTER XXVII

- | | |
|---|-----|
| Circle Diagram of the Synchronous Motor—Proof of Diagram—Construction of Diagram—Limiting Operating Conditions—Some Uses of the Circle Diagram. | 330 |
|---|-----|

CHAPTER XXVIII

- | | |
|--|-----|
| Losses and Efficiency—Advantages and Disadvantages—Uses..... | 338 |
|--|-----|

PARALLEL OPERATION OF ALTERNATORS

CHAPTER XXIX

- | | |
|--|-----|
| General Statements—Batteries and Direct-current Generators in Parallel—Alternators in Parallel—Synchronizing Action, Two Equal Alternators—Synchronizing Current—Reactance is Necessary for Parallel Operation—Constants of Generators for Parallel Operation need not be Inversely Proportional to Their Ratings. | 341 |
|--|-----|

CHAPTER XXX

- | | |
|---|-----|
| Synchronizing Action of Two Identical Alternators—Effect of Parallelizing Two Alternators through Transmission Lines of High Impedance—the Relation between r and x for Maximum Synchronizing Action. | 353 |
|---|-----|

CHAPTER XXXI

- | | |
|--|-----|
| Period of Phase Swinging or Hunting—Damping—Irrregularity of Engine Torque during Each Revolution and Its Effect on Parallel Operation of Alternators—Governors. | 361 |
|--|-----|

CHAPTER XXXII

- | | |
|--|-----|
| Power Output of Alternators Operating in Parallel and the Method of Adjusting the Load between Them—Effect of Difference in the Slopes of the Engine Speed-load Characteristics on the Division of the Load between Alternators which are Operating in Parallel—Effect of Changing the Tension of the Governor Spring on the Load Carried by an Alternator which is in Parallel with Others. | 370 |
|--|-----|

CHAPTER XXXIII

	PAGE
Effect of Wave Form on Parallel Operation of Alternators.....	377

CHAPTER XXXIV

A Resumé of the Conditions for Parallel Operation of Alternators—	382
Difference between Paralleling Alternators and Direct-current Generators—Synchronizing Devices—Connections for Synchronizing Single-phase Generators—A Special Form of Synchronizing Transformer—Connections for Synchronizing Three-phase Generators Using Synchronizing Transformers—Lincoln Synchronizer.	

SYNCHRONOUS CONVERTERS

CHAPTER XXXV

Means of Converting Alternating Current into Direct Current.....	393
--	-----

CHAPTER XXXVI

Voltage Ratio of an n-phase Converter—Current Relations.....	396
--	-----

CHAPTER XXXVII

Copper Losses of a Rotary Converter—Inductor Heating—Inductor Heating of an n-phase Converter with a Uniformly Distributed Armature Winding—Relative Outputs of a Converter Operated as a Converter and as a Generator—Efficiency.	403
--	-----

CHAPTER XXXVIII

Armature Reaction—Commutating Poles—Hunting—Methods of Starting Converters.	414
---	-----

CHAPTER XXXIX

Transformer Connections—Methods of Controlling Voltage—Split-pole Converter.	422
--	-----

CHAPTER XL

Inverted Converter—Double-current Generator—60-cycle Versus 25-Cycle Converters—Motor Generators Versus Rotary Converters.	429
--	-----

CHAPTER XLI

Parallel Operation.....	435
-------------------------	-----

CHAPTER XLII

Field Excitation and Efficiency Calculated from Armature Resistance, Winding Data, Open-circuit Core Loss and Open-circuit Saturation Curves.	437
---	-----

POLYPHASE INDUCTION MOTORS

CHAPTER XLIII

	PAGE
Asynchronous Machines—Polyphase Induction Motor—Operation of the Polyphase Induction Motor—Slip—Revolving Magnetic Field—Rotor Blocked—Rotor Free—Load is Equivalent to a Non-inductive Resistance on a Transformer—Transformer Diagram of a Polyphase Induction Motor—Equivalent Circuit of a Polyphase Induction Motor.	443

CHAPTER XLIV

Effect of Harmonics in the Space Distribution of the Air-gap Flux	455
---	-----

CHAPTER XLV

Analysis of the Vector Diagram—Internal Torque—Maximum Internal Torque and the Slip Corresponding Thereto—Effect of Reactance, Resistance, Impressed Voltage and Frequency on the Breakdown Torque and Breakdown Slip—Speed-torque Curve—Stability—Starting Torque—Fractional-pitch Windings—Effect of Shape of Rotor Slots on Starting Torque and Slip.	460
--	-----

CHAPTER XLVI

Rotors, Number of Rotor and Stator Slots, Air Gap—Coil-wound Rotors—Squirrel-cage Rotors—Advantages and Disadvantages of the Two Types of Rotor.	468
--	-----

CHAPTER XLVII

Methods of Starting Polyphase Induction Motors—Methods of Varying the Speed of Polyphase Induction Motors—Division of Power Developed by Motors in Concatenation—Losses in Motors in Concatenation.	471
---	-----

CHAPTER XLVIII

Calculation of the Performance of an Induction Motor from Its Equivalent* Circuit—Determination of the Constants for the Equivalent Circuit.	484
--	-----

CHAPTER XLIX

Circle Diagram of the Polyphase Induction Motor—Scales—Maximum Power, Power Factor and Torque—Determination of the Circle Diagram.	490
--	-----

CHAPTER L

General Characteristics of the Induction Generator—Circle Diagram of the Induction Generator—Changes in Power Produced by a Change in Slip—Power Factor of the Induction Generator—Phase	497
--	-----

Relation between Rotor Current Referred to the Stator and Rotor Induced Voltage, E_2 —Vector Diagram of the Induction Generator—Voltage, Magnetizing Current and Function of Synchronous Apparatus in Parallel with an Induction Generator—Use of a Condenser instead of a Synchronous Generator in Parallel with an Induction Generator—Voltage, Frequency and Load of the Induction Generator—Short-circuit Current of the Induction Generator—Hunting of the Induction Generator—Advantages and Disadvantages of Induction Generators—Use of Induction Generators.

CHAPTER LI

Calculation of the Constants of a Three-phase Induction Motor for the 505
Equivalent Circuit—Calculation of Output, Torque, Input, Efficiency, Stator Current and Power Factor from Equivalent Circuit for a Given Slip.

SINGLE-PHASE INDUCTION MOTORS

CHAPTER LII

Single-phase Induction Motor—Windings—Method of Ferraris for 511
Explaining the Operation of the Single-phase Induction Motor.

CHAPTER LIII

Quadrature Field of the Single-phase Induction Motor—Revolving 516
Field of the Single-phase Induction Motor—Explanation of the Operation of the Single-phase Induction Motor—Comparison of the Losses in Single-phase and Polyphase Induction Motors.

CHAPTER LIV

Vector Diagram of the Single-phase Induction Motor—Generator 527
Action of the Single-phase Induction Motor.

CHAPTER LV

Commutator-type, Single-phase, Induction Motor—Power-factor Com- 533
pensation—Vector Diagrams of the Compensated Motor—Speed Control of the Commutator-type, Single-phase, Induction Motor—Commutation of the Commutator-type, Single-phase, Induction Motor.

CHAPTER LVI

Methods of Starting Single-phase Induction Motors..... 545

CHAPTER LVII

The Induction Motor as a Phase Converter..... 551

SERIES AND REPULSION MOTORS

CHAPTER LVIII

PAGE

- Types of Single-phase Commutator Motors with Series Characteristics 555
 —Starting—Doubly Fed Motors—Diagrams of Connections for
 Singly and Doubly Fed Series and Repulsion Motors—Power-
 factor Compensation.

CHAPTER LIX

- Singly Fed Series Motor—Vector Diagram—Approximate Vector 559
 Diagram—Over- and Under-compensation—Starting and Speed
 Control—Commutation—Inter-poles—Construction, Efficiency
 and Losses of Series Motors.

CHAPTER LX

- Singly Fed Repulsion Motor—Motor at Rest—Motor Running— 570
 Vector Diagram—Commutation—Comparison of the Series and
 Repulsion Motors.

CHAPTER LXI

- Compensated Repulsion Motor—Diagram of Connections—Phase 583
 Relations between Fluxes, Currents and Voltages—Power-factor
 Compensation—Commutation—Vector Diagram—Speed Control
 and Direction of Rotation—Advantages and Disadvantages of the
 Compensated Motor.

CHAPTER LXII

- Doubly Fed Series and Repulsion Motors—Doubly Fed Series Motor— 595
 Approximate Vector Diagram of the Doubly Fed Series Motor—
 Commutation of the Doubly Fed Series Motor—Starting and
 Operating the Doubly Fed Series Motor—Doubly Fed Repulsion
 Motor—Doubly Fed Compensated Repulsion Motor—Regenera-
 tion by the Doubly Fed Compensated Repulsion Motor—Advan-
 tages of the Two Types of Doubly Fed Motors—Compensation
 and Commutation of the Doubly Fed Compensated Repulsion
 Motor—Starting and Speed Control of the Doubly Fed Compen-
 sated Repulsion Motor.

- INDEX..... 605

PRINCIPLES OF ALTERNATING-CURRENT MACHINERY

SYNCHRONOUS GENERATORS

CHAPTER I

TYPES OF ALTERNATORS; FREQUENCY; ARMATURE CORES; FIELD CORES; ARMATURE INSULATION; FIELD INSULATION; COOLING; FILTERING OR WASHING COOLING AIR; PERMISSIBLE TEMPERATURES FOR DIFFERENT TYPES OF INSULATION

Types of Alternators.—Alternating-current generators do not differ in principle from generators for direct current. Any direct-current generator, with the exception of the unipolar generator, is, in fact, an alternator in which the alternating electromotive force set up in the armature inductors is rectified by means of a commutator. Although any direct-current generator, with the exception of the unipolar generator, may be used as an alternator by the addition of collector rings electrically connected to suitable points of its armature winding, it is found more satisfactory, both mechanically and electrically, to interchange the moving and fixed parts when only alternating currents are to be generated. It is not only a distinct advantage mechanically to have the more complex part of the machine stationary, but it is, moreover, easier with this arrangement to protect and insulate the armature leads which usually carry current at high potential. The only moving contacts required are those necessary for the field excitation and these carry current at low potential.

Alternating-current generators may be divided into three classes which differ mainly in the disposition and arrangement of their parts. The three classes are:

- (a) Alternators with revolving fields.
- (b) Alternators with revolving armatures.
- (c) Inductor alternators.

All modern alternators with very few exceptions belong to the first class for reasons which have already been stated. Inductor alternators differ from the other two types by having the variation in the flux through their armature windings produced by the

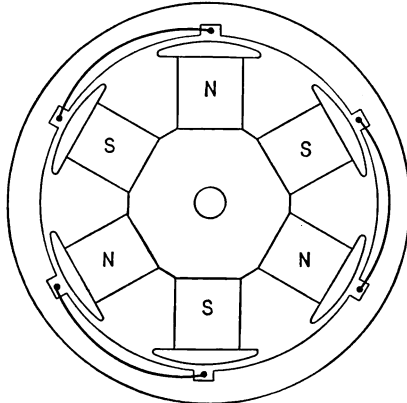

FIG. 1.

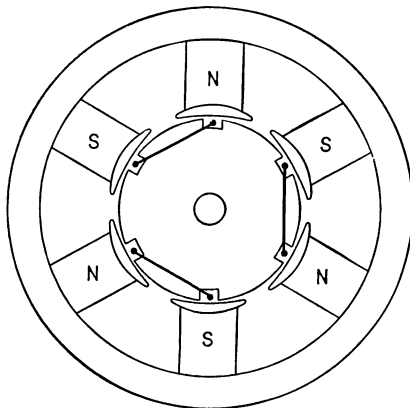

FIG. 2.

rotation of iron inductors. The windings of both the armature and the field of this type of alternator may be stationary. A distinguishing feature of an inductor alternator is that any one set of armature coils is subjected to flux of only one polarity. This fluctuates between the limits of zero and maximum, but does

not reverse. Figs. 1, 2, and 3 illustrate the three classes of alternators in their simplest forms.

Fig. 3 shows two views of one type of inductor alternator. The left-hand view is a portion of a section taken parallel to the shaft about which the inductor revolves. The other half of the figure is a side view. The letters on this figure have the following significance:

- F*—Field coil
A—Shaft
CC—Armature coils
NIS—Inductor.

By referring to Figs. 1 and 2 it will be seen that both sides of coils on the armatures of the revolving-field and the revolving-armature types of generators are in active parts of the field at the

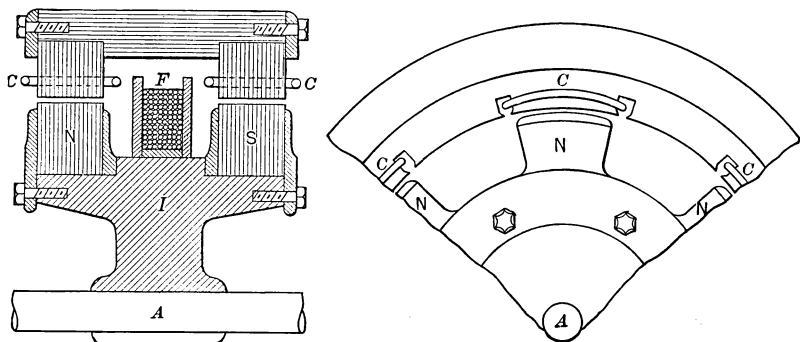

FIG. 3.

same time, and, since the opposite sides of the coils are under poles of opposite polarity at each instant, the electromotive forces induced in them will be in phase with respect to the coil. The conditions are different in the case of the inductor type of alternator. In this alternator only one side of an armature coil is in an active part of the field at any time, the other side being between two poles. Therefore, either the turns or the flux must be doubled in order to get the same voltage as would be obtained if the flux through the armature winding reversed as it does in the other two types of alternators. Inductor alternators are usually characterized by large armature reaction, relatively high magnetic

density, small air gap and greater weight than alternators of the other types. The difficulties in the design of a satisfactory inductor alternator have caused this type of alternator to go out of use.

Frequency.—The commercial frequencies which are most common in America are 60 and 25 cycles per second. In Europe both 50 and 40 cycles are used. Twenty-five cycles is used for long-distance power transmission, but so low a frequency is not suitable for lighting on account of the very noticeable flicker produced by it on arc lights and all incandescent lamps except those with filaments of large cross-section. A frequency of 25 cycles or less is best adapted for single-phase motors of the series or repulsion type such as are used for traction purposes.

The frequency given by any alternator depends upon its speed and number of poles and is equal to

$$f = \frac{pn}{2(60)} \quad (1)$$

where f , p and n are, respectively, the frequency in cycles per second, the number of poles and the speed in revolutions per minute. The speed, and therefore the number of poles for which an alternator for a given frequency is designed, depends upon the method of driving it. Engine-driven alternators as well as alternators driven by water wheels operated from low heads must run at relatively low speeds and, consequently, they must have many poles. On the other hand, alternators driven by steam turbines operate at very high speeds and must have very few poles, usually from two to six according to their frequency and size. Low-frequency alternators are always heavier and therefore more expensive than high-frequency alternators of the same kilovolt-ampere rating and speed, but the advantages of low frequency for certain classes of work, notably power transmission and traction, usually more than balance the higher cost of the low-frequency alternators.

Armature Cores.—The armature cores of all alternators are built up of thin sheet-steel stampings with slots for the armature coils on one edge. The opposite edge usually has either two or more notches for keys which are inserted in the frame in which the laminations are built up, or projections which fit in slots cut in the frame. Notches cut in the sides of the teeth serve to hold

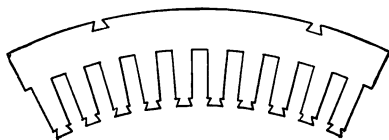

FIG. 4.

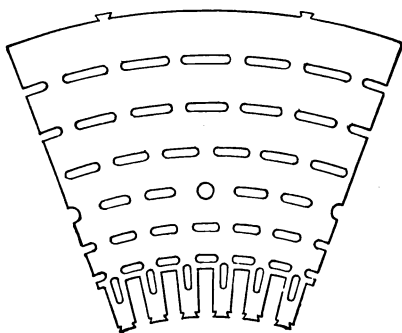

FIG. 5.

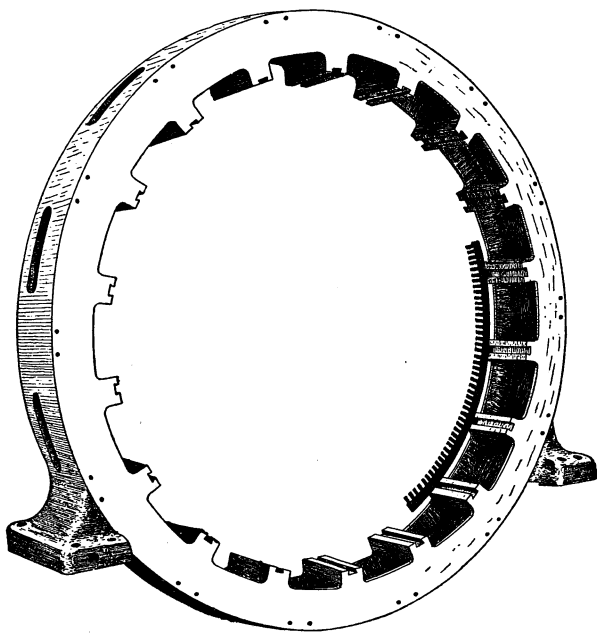

FIG. 6.

the wedges driven between adjacent teeth to keep the coils in place. Typical armature stampings are shown in Figs. 4 and 5, which illustrate, respectively, stampings for a slow- or moderate-speed alternator and a turbo alternator. The holes through the laminations for the turbo alternator form passages, when the laminations are built up, through which air is forced for cooling the armature.

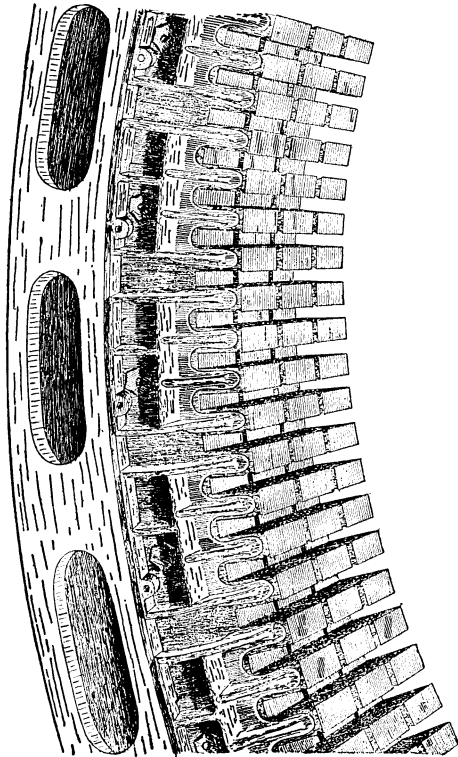

FIG. 7.

The armature stampings are built up with lap joints in a frame or yoke ring, usually of cast steel, and are held from slipping either by keys inserted in the frame or by projections on the laminations. They are securely bolted together and to the frame between end plates. These plates usually have projecting fingers to support the teeth. Fig. 6 shows a typical frame for an engine-driven

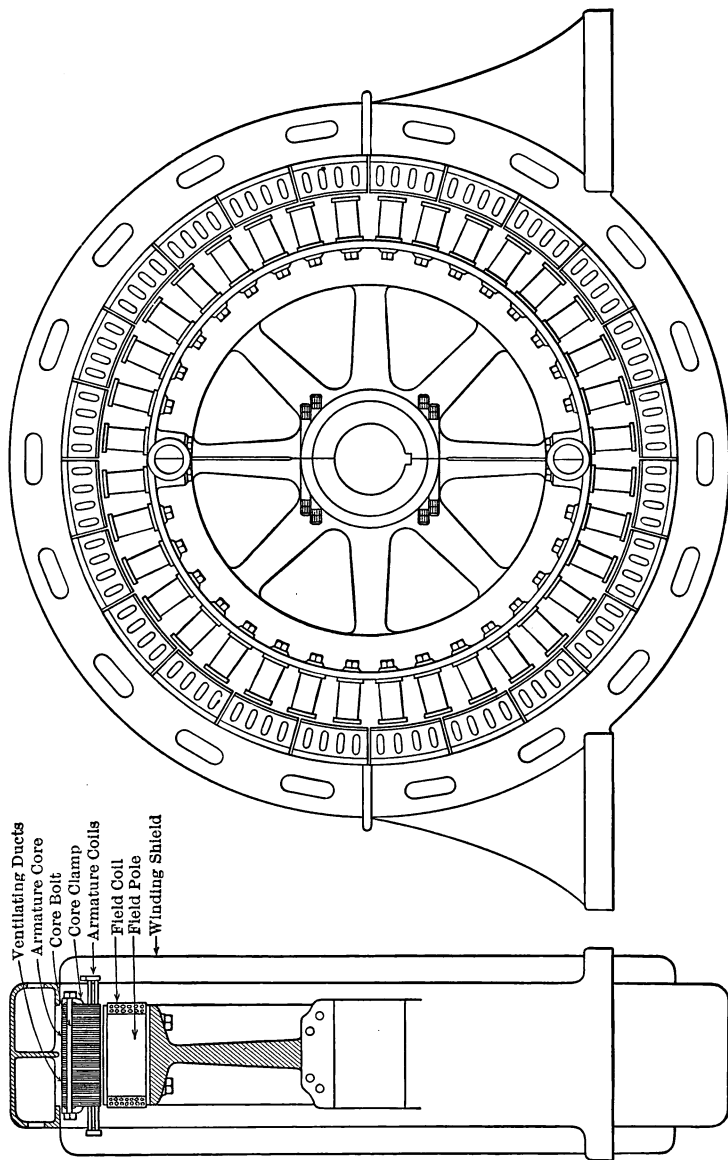

Fig. 8.

alternator with one lamination in place. Fig. 7 gives a view of a portion of an armature core and frame and illustrates one form of end plate and a method of bolting the laminations together. The frame or yoke which supports the laminations is hollow and is provided with openings for ventilation. The armature laminations are separated in two or more places by the insertion of

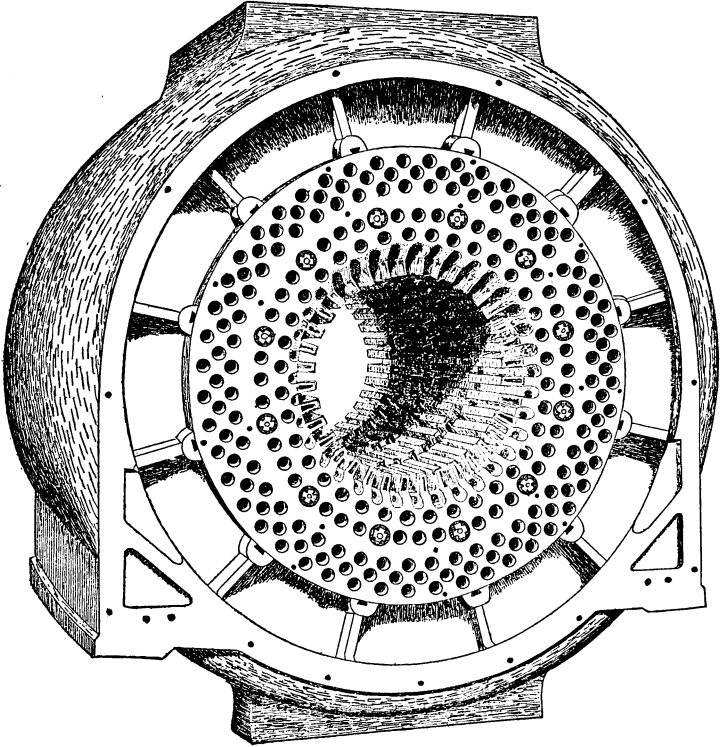

FIG. 9.

spacing pieces in order to provide radial air ducts for cooling the armature. Except for very small generators, frames or yoke rings are made in two or more sections bolted together which may be separated for transportation. A complete engine-driven generator is shown in Fig. 8.

A typical frame for a turbo alternator with the laminations in

place is shown in Fig. 9. As turbo alternators require forced ventilation, they must be completely enclosed.

Field Cores.—All slow-speed alternators of standard design have laminated salient or projecting poles built up of steel stampings. These are bolted together and either keyed or bolted to a

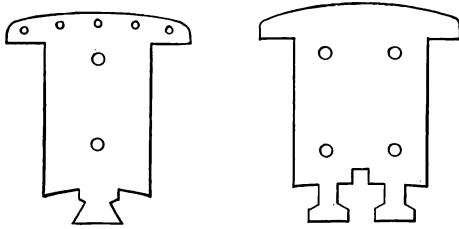

FIG. 10.

steel spider which is itself keyed to the shaft. Fig. 10 shows typical pole stampings. Fig. 11 shows the core of a complete pole of the bolted-on type both with and without the winding. This type is also illustrated in Fig. 8. A complete field with the poles and winding in place is shown in Fig. 12

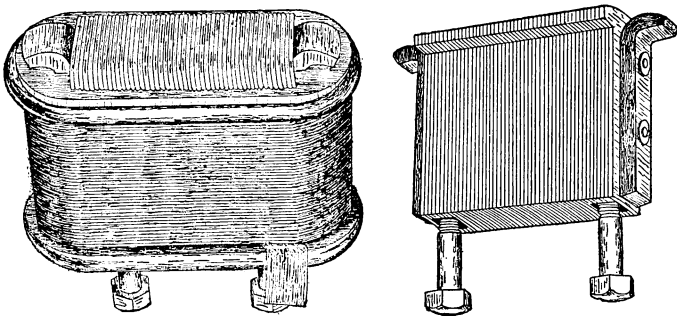

FIG. 11.

The field structure of a high-speed turbo alternator does not have projecting poles. It is cylindrical in form and has slots cut in its surface for the field winding. Such alternators have from two to six poles according to their size and the frequency. Projecting or salient poles would cause excessive windage losses and in addition would make a high-speed alternator very noisy.

Moreover, it would be difficult if not impossible to make a field structure with salient poles sufficiently strong to safely stand the high speeds used for turbo generators.

The field structure for a small or moderate-size turbo alternator is often a solid steel forging. For a large machine it is built up of thick discs cut from forged steel plates. The shaft,

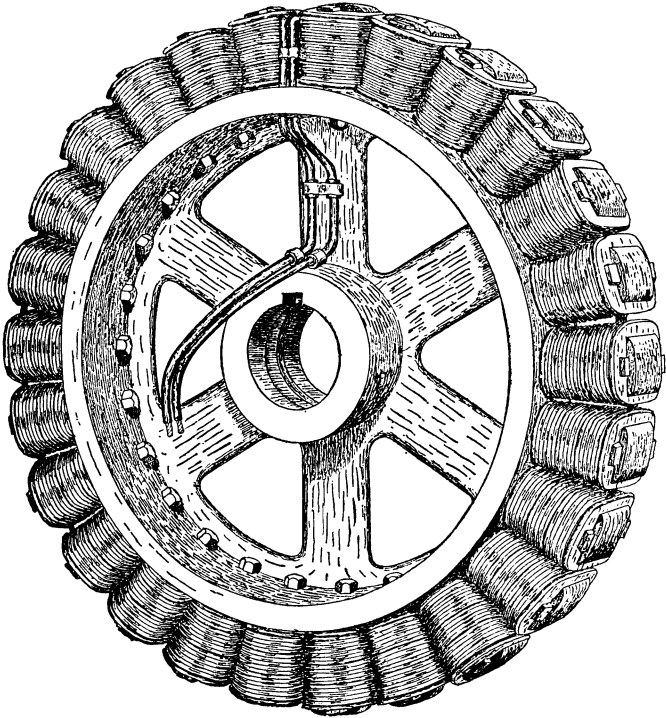

FIG. 12.

except in small machines, does not as a rule pass through the core, as the hole required in the core for this would remove too much metal back of the slots which receive the field winding and thus weaken the structure. The shaft is in two pieces fastened to end plates securely bolted to the core. The distribution of flux over the pole faces is determined by the distribution of the field coils which are placed in slots cut in the core.

There are two types of cylindrical field cores which differ in the way in which the slots for the field winding are cut. These are the radial-slot and the parallel-slot types. They are illustrated in Figs. 13 and 14, respectively, both of which show two-pole fields. When parallel slots are used for fields with more

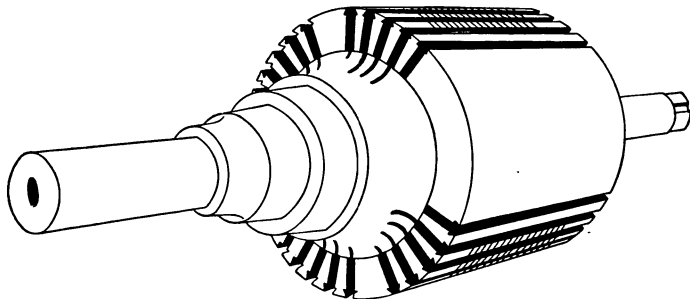

FIG. 13.

than two poles, they produce the effect of salient poles. Four-pole parallel-slot fields are seldom used. The radial-slot type is the better in most cases, even when there are only two poles, as its teeth are subjected only to radial stresses. The teeth of the parallel-slot type of field, in addition to the radial stress, have to support a lateral stress arising from the centrifugal force on them and on the field coils.

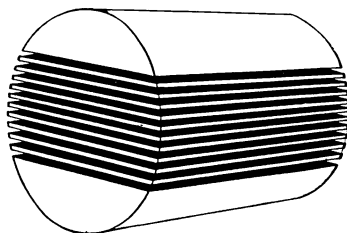

FIG. 14.

Field cores with parallel slots have the slots cut across their ends as well as on their faces, permitting the exciting coils to be completely embedded. It is obvious, under these conditions, that the end plates which carry the shaft cover the end connections of the winding and that no external support is required to

hold them in place. The end connections on each end of a radial-slot type of field are held in place by a steel ring of high tensile strength which covers them.

With the two-pole parallel-slot type of field, the shaft must be made in two parts and bolted on, but the shaft may be integral with the core when more than two poles are used.

Armature Insulation.—The conductors which form the coils of alternators, as well as the coils themselves, must be insulated in much the same way as the conductors and coils of direct-current generators. On account of the high voltages at which alternators usually operate, they require much more insulation than direct-current machines. The materials used in the insulation of direct-current generators are often not suitable for alternators on account of the higher voltages of the latter and the higher temperatures often reached by their windings.

Vulcanized fiber, horn fiber, fish paper, varnished cambric and paper, mica and other similar materials are used in the insulation of alternators. When high temperatures do not have to be resisted by the armature windings, double- or triple-cotton-covered wire is used for the coils. These are thoroughly impregnated with insulating compound after being wound and are then given several layers of varnished cambric or of some other similar material. With such coils it is necessary to insulate the slots with fiber or mica. Vulcanized fiber has a tendency to absorb moisture which causes it to expand and also reduces its insulating properties. For this reason it should not be relied upon to insulate high-voltage machines.

Mica is the only reliable insulation when high voltage or high temperature is to be encountered. The objection to mica is its poor mechanical properties, and for this reason it has to be used with other materials. For insulating slots it is split into thin flakes which are built up with lap joints into sheets with varnish or bakelite to cement the mica together. It is then baked under pressure. When built up in this way, the finished sheet may be moulded hot in U-shaped troughs or into other shapes for insulating the slots or other parts of the machine.

Mica is now almost exclusively used for the insulation of high-voltage alternators and especially for the insulation of turbo alternators. With the high speeds necessary for turbo alterna-

tors, comparatively few armature turns are required for a given voltage. This increases the voltage per turn and necessitates more insulation between turns. Large machines often have only one or two turns per coil. Although fibrous insulation could still be applied which would withstand the higher voltage between turns, mica is the only substance which will withstand the high temperatures reached by certain parts of the coil which are embedded in the armature iron. The portions of the inductors and coils which are embedded in the slots are insulated with mica which is built up with varnish upon thin cloth or paper and applied to the straight portions of the conductors which lie in the slots as well as to similar portions of the finished coils. It is found in practice that the supporting cloth or paper may be destroyed by heat without impairing the insulation of the coils, provided they are firmly held in place in the slots. The percentage of the space occupied by the cloth or paper is small as compared with the space occupied by the mica, and experience has shown that the complete carbonization of the cloth or paper by maintained high temperature does not cause the coils to loosen in the slots. The portions of the coils which lie without the slots, *i.e.*, the end connections, are insulated with varnished cambric, mica tape or some similar material.

The mica insulation is now generally applied and rolled hot on the straight portions of the conductors and coils by the Haefly process, which was developed in Europe and is extensively used in America. By this process the mica wrappers are so tightly rolled on the coil that they form a solid mass of insulating material of minimum thickness free from air spaces and having good heat conductivity. Mica insulation applied in the ordinary way has a heat conductivity of only 60 or 70 per cent. of that of varnished cambric and similar materials.

The static discharge which was often encountered between the armature copper and iron in the earlier high-voltage alternators is avoided when rolled-on mica insulation is used. As would be expected, the effect of the static discharge was most marked where there were sharp edges, as at the edges of the radial ventilating ducts. Its effect is to eat holes in and to pit the outside insulation of the coils, weakening or even destroying the insulation. One method of avoiding this static discharge, which has

been used with some success, consists of wrapping with tin foil the portions of the insulated coils which pass through the slots before giving them their protecting layer of tape, and grounding the metallic sheath thus formed to the core.

Field Insulation.—Since the fields of alternators are always wound for low voltage, 125 to 250 volts, the problem is not so much one of insulation as of providing a mechanical separation between the turns which shall be mechanically strong and shall withstand high temperature. Neither the problem of mechanical strength nor of high temperature is serious in the case of slow-speed alternators, since the stresses and temperatures which have to be withstood by the field windings of such machines are not great.

In case an alternator becomes short-circuited, the field winding may be subjected to high voltage during the initial rush of armature current due to the transformer action which takes place between the armature and field. This action as a rule is not serious. It is least in alternators with non-salient poles and low field reactance. Sufficient insulation must be provided on the field winding to guard against breakdown due to this cause.

Generators with salient poles usually have their fields wound with double-cotton-covered wire with insulating strips between layers. After being wound, the coils are impregnated with insulating compound and taped. They are then placed on insulating spools of fiber or similar material and slipped over the pole pieces. Fields are often wound with flat strip copper wound on edge. In this case the successive turns are insulated from one another by insulating strips of thin asbestos paper or other material. The copper at the outside surface of edgewise-wound field coils is left bare to facilitate cooling.

The windings of cylindrical fields, such as are used for turbo alternators, are subjected to much greater stresses, on account of the high speed at which they operate, than the windings of fields having salient poles. At times of short-circuit the stresses in the field windings of large turbo generators become very great. Ordinary cotton insulation would not have sufficient strength to withstand the severe crushing stresses at such times, especially if the insulation had become slightly carbonized by the high temperatures at which the fields of such machines generally op-

erate. The only material which will withstand the high temperature, and which is at the same time sufficiently strong, is mica. The slots of the cylindrical fields of turbo alternators are insulated with mica troughs and the separate turns of the field windings, which consist of flat strips of copper laid in the slots by hand, are separated from each other by thin strips of asbestos or mica paper.

Cooling.—All generators are air cooled either by natural or by forced ventilation. There are four things which must be considered in the cooling or ventilation of any generator, namely: the total losses to be dissipated, the surface exposed for dissipating these losses, the quantity of air required and the temperature of the cooling air. The rate at which heat is lost from any heated surface depends upon the difference in temperature between the heated surface and the cooling medium, which in the case of generators is always air. If the quantity of air supplied is too small, the cooling air will reach a temperature which is nearly the same as the temperature of the surface to be cooled and little heat will be carried off. If, on the other hand, the quantity of air is large, its temperature will be only slightly increased. Any increase in the volume of air beyond this point will produce very little further gain in cooling and is wasteful.

There is little difficulty in cooling slow-speed engine-driven generators. By providing proper ventilating ducts in the armature laminations and openings in the frame, with, in some cases, fans added to the rotors, the cooling of such generators can be handled without difficulty. The conditions are, however, very different in the case of high-speed turbo alternators.

The output of turbo alternators is very great per unit volume and the quantity of heat which must be dissipated per unit area of available cooling surface is very large. Forced ventilation must be used for such generators, and even with this it is exceedingly difficult to get sufficient air through the air gap and such other passages as can be provided. For this reason very large turbo generators must operate at a higher temperature than low-speed generators of smaller output and the insulation used in their construction must be such as to withstand the higher temperature. Mica insulation is universally used for such machines.

One kilowatt acting for one minute will raise the temperature of 100 cu. ft. of air approximately 18°C . Assuming a 20,000-kv.-a. generator with an efficiency of 97 per cent., 600 kw. will have to be taken up by the cooling air. If the increase in the temperature of the air in passing through the machine is not to exceed 20° , $600 \times 100 \times \frac{1\frac{1}{2}}{20} = 54,000$ cu. ft. of air will be required per minute. If this has a velocity of 5000 ft. per minute, ventilating ducts of nearly 11 sq. ft. cross-section will be required. Since, in the case of such a machine, the air would be passed in from both ends, ducts of only half this cross-section will be required. With the cooling air passed in from both ends and with velocities as high as 5000 to 6000 ft. per minute, such as are actually used in practice, it would be exceedingly difficult to provide ventilating ducts of sufficient cross-section. The ventilating duct formed by the air gap between the field and armature alone would not begin to be sufficient. To use forced ventilation it is obviously necessary to completely enclose a machine.

There are three methods of artificially ventilating turbo alternators which are designated according to the way the cooling air is passed through the machine. These are radial ventilation, circumferential ventilation and axial ventilation. Air-gap ventilation is used in conjunction with these.

Radial Ventilation.—In the radial method of cooling large alternators, the cooling air is passed in along the air gap from both ends and out through radial ducts made in the armature core by inserting spacing pieces between the armature laminations. As a rule, when radial-slot rotors are used they are provided with radial ducts. Air is passed through the rotor under the slots, out through these radial ducts and thence through the stator ducts. All of the air passes out through the radial ducts in the stator. The air gap alone, with any reasonable air velocity, is not sufficient in most cases to allow the passage of sufficient air for cooling the stator. Radial ventilation has been used with success, but when applied to large generators it is difficult to pass sufficient air to keep the stator cool. There is no difficulty in cooling the rotor, but the losses in it are not over 10 or 15 per cent. of the total losses to be taken care of.

Circumferential Ventilation.—When the circumferential method of ventilation is used, the air for cooling the stator is supplied to one or more openings in the circumference of the stator and passes around through ducts in the stator core in two directions from each opening and out other openings also in the circumference of the stator, without entering the air gap. If air is admitted at only one point on the circumference, it passes out at a point diametrically opposite. In addition to the air for cooling the stator, air must also be supplied to the air gap for cooling the rotor.

Axial Ventilation.—A common objection to both the radial and circumferential methods of cooling is that the heat developed in the stator must pass transversely across the laminations to the air ducts in order to be carried off by the cooling air. The rate of heat conduction across a pile of laminations is not over 10 per cent. as great as along them. Since in both the radial and circumferential methods of cooling the heat must pass across the laminations to the air ducts, neither of these methods is as efficient as one where the heat passes along the laminations to the air ducts. This is the way the heat passes in the axial method of cooling. For this method, numerous holes are punched in the armature stampings. When the stampings are built up, these holes form ducts in the armature core which are parallel to the axis of the machine, and which may extend either uninterruptedly from one side to the other or from each side to one or more large central radial channels or ducts which form the outlet. The stator and the armature stamping shown in Figs. 9 and 5, respectively, are for axial ventilation. Air-gap ventilation is used for cooling the rotor.

Filtering or Washing the Cooling Air.—The quantity of air which passes through a large turbo generator is very great and may reach 50,000 to 75,000 cu. ft. per minute. Even if the cooling air is reasonably clean, enormous quantities of foreign matter must be carried by it through the ventilating ducts in the course of a year and the deposit of even a small percentage of this is serious. Fortunately, the high air velocity which it is necessary to use in the ducts tends to make generators self-cleaning. If, however, any moisture or more especially any oil gets into the passages, it will quickly collect foreign matter.

Certain types of generators require cleaning at more or less frequent intervals in order to keep their ducts free, and it is advisable to clean all types occasionally.

With the types of alternators used in America, it has not been necessary to clean the cooling air except when the conditions are particularly bad, as, for example, when turbo generators are operated near coal mines or in a smelting plant where the air contains enormous quantities of dust.

The most satisfactory method of cleaning the air is by washing it by passing the air through sprays of water before it enters the generator. This method of cleaning the cooling air has the double advantage of increasing its humidity and at the same time cooling it. A decrease of even 5° or 10° in the air entering a generator will very appreciably increase its permissible maximum output.

Permissible Temperatures for Different Types of Insulation.—All insulating materials are injured or destroyed by high temperature. The continued application of a temperature which would not injure an insulating material if applied for a short time will cause it to slowly deteriorate and ultimately to be destroyed. The continued application of even quite moderate temperatures to cotton, silk, shellac, varnishes and other similar materials commonly used for insulating electrical apparatus causes them to carbonize and to lose their insulating qualities and mechanical strength. Mica alone is the one substance used for insulating electrical apparatus which will stand high temperatures, but mica can seldom be used alone without being built up into sheets or strips with shellac or some form of varnish as a binder. Except where the binder is used only for structural purposes and where its destruction, when the insulation is once in place, does not decrease the insulating properties or the mechanical strength of the built-up material, mica insulation cannot be used for much higher temperatures than cotton or silk. In many cases where built-up mica insulation is employed, as, for example, for insulating the slots and the straight parts of armature coils which are embedded in the iron, the binder may be destroyed without injury to the insulation, provided the coils are held firmly in place.

The temperature limits recommended in the revised Standardization Rules (1914) of the American Institute of Engineers are:

*A*₁. For cotton, silk and other fibrous materials not treated to increase their thermal limit, 95°C.

*A*₂. For the substances named under *A*₁ but treated or impregnated, and for enameled wire, 105°C.

*B*₁. Mica, asbestos, or other materials capable of resisting high temperatures in which any class *A* material or binder if used is for structural purposes only, and may be destroyed without impairing the insulating or mechanical qualities, 125°C.

CHAPTER II

INDUCED ELECTROMOTIVE FORCE; PHASE RELATION BETWEEN A FLUX AND THE ELECTROMOTIVE FORCE IT INDUCES; SHAPE OF FLUX AND ELECTROMOTIVE FORCE WAVES WHEN COIL SIDES ARE 180 ELECTRICAL DEGREES APART; CALCULATION OF THE ELECTROMOTIVE FORCE INDUCED IN A COIL WHEN THE COIL SIDES ARE NOT 180 ELECTRICAL DEGREES APART

Induced Electromotive Force.—The electromotive force induced in a direct-current generator depends upon its speed, the number of armature inductors connected in series between brushes and the total flux per pole, and is independent of the manner in which the flux is distributed, provided the brushes are in the neutral plane. In the case of an alternator, however, the electromotive force depends upon the way in which the flux is distributed. The same total flux can be made to give different values of maximum and of root-mean-square electromotive forces by merely changing its distribution. The value of the electromotive force will also depend upon the arrangement of the armature winding such as its pitch and coil spread.

The electromotive force induced in any coil on the armature of an alternator is given by

$$e = - N \frac{d\varphi}{dt}$$

where N , φ and e are, respectively, the number of turns in the coil, the flux enclosed by the coil and the instantaneous electromotive force. A coil consists of a number of turns which are laid in a single pair of slots. The terms coil and phase must not be confused. A phase usually consists of a number of coils which occupy different pairs of slots and which are generally connected in series. Let the flux from the poles be so distributed that the flux linking with any armature coil varies as some function of the maximum flux, φ_m , and the angular displacement, α , of the coil from its position directly opposite a pole. The angle α will be

expressed in electrical radians or electrical degrees where 2π electrical radians or 360 electrical degrees are equivalent to the distance between the centers of consecutive poles of like polarity. If the generator is bipolar, 360 electrical degrees will correspond to 360 space degrees. Then

$$\varphi = f(\varphi_m, \alpha)$$

and

$$e = -N \frac{d}{dt} f(\varphi_m, \alpha).$$

The root-mean-square voltage is

$$E = -N \left[\frac{1}{\pi} \int_0^\pi \left\{ \frac{d}{dt} f(\varphi_m, \alpha) \right\}^2 d\alpha \right]^{1/2}.$$

If the flux in the air gap between the pole faces and the armature is distributed in such a way that the flux through the coil varies as the cosine of the angular displacement, α , of the coil from the position where the flux through it is a maximum,

$$\begin{aligned} e &= -N \frac{d}{dt} \varphi_m \cos \alpha \\ &= -N \frac{d}{dt} \varphi_m \cos \omega t, \end{aligned}$$

where ω is the angular velocity of the armature in electrical radians per second and t is the time in seconds required for it to move through the angle $\alpha = \omega t$.

$$\begin{aligned} e &= \omega N \varphi_m \sin \omega t \\ E &= \omega N \left[\frac{\omega}{\pi} \int_0^\pi \varphi_m^2 \sin^2 \omega t dt \right]^{1/2} \\ &= \omega N \varphi_m \frac{1}{\sqrt{2}} \\ &= 2\pi \frac{p}{2} \frac{n}{60} N \varphi_m \frac{1}{\sqrt{2}}, \end{aligned}$$

where p and n have the same significance they had in equation (1) page 4. Therefore,

$$E = 4.44 N f \varphi_m 10^{-8} \text{ volts.} \quad (2)$$

This equation holds only when the flux distribution in the air gap is such as to produce a sinusoidal voltage wave in the arma-

ture coils. If the armature has more than one coil per phase, and if the adjacent coils are separated by a distance equal to the distance between either adjacent or alternate poles, the phase voltage will be equal to the electromotive force given by formula (2) multiplied by the number of coils connected in series. When the coils are separated by a distance equal to the distance between adjacent poles, they must be connected alternately right- and left-handed in order to have their electromotive forces add. When they are separated by a distance equal to the distance between alternate poles, they must all be connected in the same way. If the distance between the adjacent coils is not equal to either the distance between adjacent or alternate poles, the electromotive forces generated in these coils will be out of phase and cannot be added directly. The discussion of the effect of this will be taken up later.

Phase Relation between a Flux and the Electromotive Force it Induces.—The difference in phase between a flux and the electromotive force it induces when both are considered with respect to a coil and when both are considered with respect to an inductor should not be overlooked. An inductor is one of the two active sides of each turn of a coil. Its length is equal to the length of that portion of the coil side which actually cuts flux.

Assume that the two active sides of a coil are 180 electrical degrees apart. Under this condition, when the coil is directly over a pole and contains a maximum flux its two active sides are midway between the poles and are in zero field. They are cutting no flux and the electromotive force induced in them is zero. When the coil has moved forward 90 electrical degrees the flux through it becomes zero, but the inductors are now directly under the centers of opposite poles and are in the strongest part of the fields. The electromotive forces induced in them will be a maximum and opposite in direction with respect to the two inductors. The voltage in the coil is always equal to the vector difference between the electromotive forces induced in its two inductors.

It follows that while an electromotive force in a coil is in time quadrature with respect to the flux through it, the electromotive force in the inductors and the intensity of the field or the flux density at the inductors are in time phase. The inductors move

at uniform speed across the field and the voltage induced in them must at every instant be proportional to the strength of the field in which they are moving. It is equal in c.g.s. units to the intensity of the field in gaussses multiplied by the length of the inductor in centimeters and its velocity in centimeters per second.

Shape of Flux and Electromotive Force Waves when the Coil Sides are 180 Electrical Degrees Apart.—If the sides of a coil are 180 degrees apart and the distribution of the air-gap flux which they cut is a sine function of the distance measured from

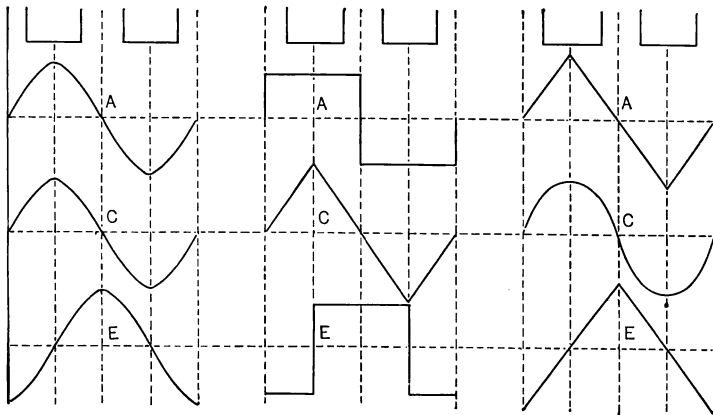

A Air-Gap Flux
 C Flux through Coil
 E Emf. in Coil

FIG. 15.

a point midway between the poles, the variation of flux through the coil with respect to time will be a cosine function and the electromotive force induced in the coil will be sinusoidal. If the flux has any other distribution, the time variation of flux through the coil will have a different wave form than the space distribution of the flux. The wave form of the electromotive force induced in the coil, however, will be the same as the wave form of the space distribution of the flux in the air gap, since the electromotive forces in the two inductors are opposite and at each instant proportional to the strength of fields in which they move.

Fig. 15 shows curves of the space variation of flux in the air gap and the corresponding time curves of flux through a coil,

and the electromotive force produced in a coil with inductors 180 electrical degrees apart, by a sine, a rectangular and a triangular space distribution of the air-gap flux.

The Calculation of the Electromotive Force Induced in a Coil when the Coil Sides are not 180 Electrical Degrees Apart.—In case the sides of a coil are not 180 electrical degrees apart, the

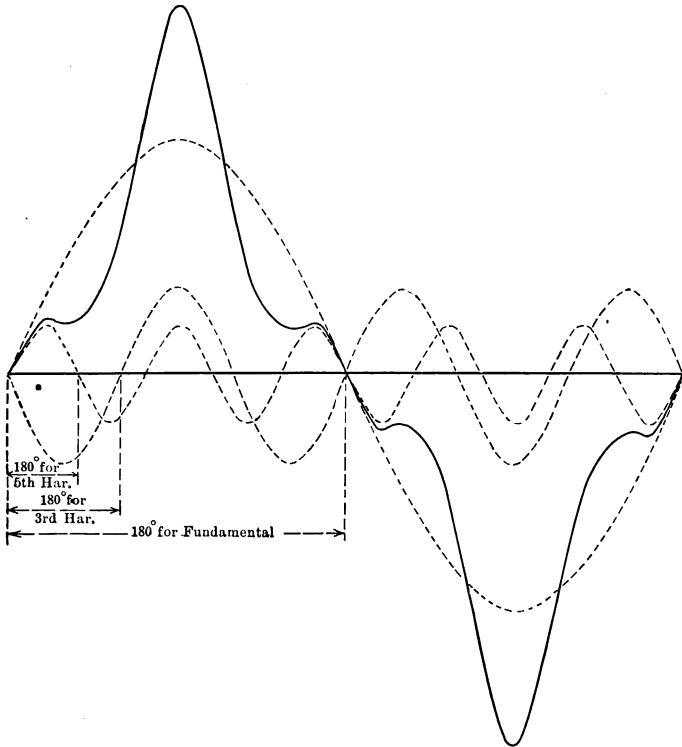

FIG. 16.

voltages in them will not be in phase at every instant when considered around the coil. The voltage in the coil, however, will still be equal to the vector difference of the voltages induced in its active sides.

If the distribution of the flux is not sinusoidal but its distribution in the air gap is known in terms of a fundamental and a series of harmonics, the voltage in the coil at each instant may

be found by taking the vector differences of the voltages induced in the inductors of the coil by the fundamental and each of the harmonics separately. Fig. 16 gives a distribution of flux which contains a fundamental and third and fifth harmonics. Inspection of this curve should make it clear that any change, α , in the angular distance between the two inductors of a coil corresponds to a change in phase between the voltages in the two inductors of α for the fundamental and $n\alpha$ for the n th harmonic.

Let the space distribution of flux in the air gap of an alternator measured from a point midway between the poles be

$$\mathcal{B} = \mathcal{B}_1 \sin \alpha + \mathcal{B}_3 \sin 3\alpha + \mathcal{B}_5 \sin 5\alpha$$

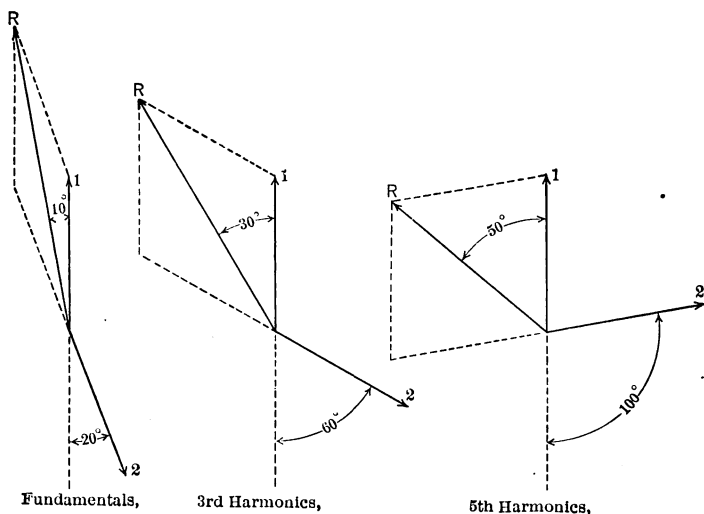

FIG. 17.

where the \mathcal{B} 's represent the maximum flux densities for the fundamental and the harmonics, and α is the angular distance measured around the gap from the reference point midway between the poles. If the inductors of the coil are 160 electrical degrees apart, the fundamentals of the voltages in the two inductors will be 20 degrees out of phase opposition, the third harmonics $3 \times 20 = 60$ degrees and the fifth harmonics $5 \times 20 = 100$ degrees. The vectors for the fundamentals and the harmonics are

shown in Fig. 17. In this figure the R 's are the resultant voltages. 1 and 2 are the voltages in inductors 1 and 2 respectively.

If the coil contains N turns and moves with a velocity of v cm. per second, and the length of the inductors which cut flux is L , the voltage in volts induced in the coil referred to the voltage in inductor 1 is

$$e = 2LvN10^{-8} \{ \mathfrak{B}_1 \cos 10^\circ \sin (\alpha + 10^\circ) + \mathfrak{B}_3 \cos 30^\circ \sin (3\alpha + 30^\circ) + \mathfrak{B}_5 \cos 50^\circ \sin (5\alpha + 50^\circ) \}$$

The root-mean-square value of this voltage is equal to the square root of one-half the sum of the squares of the maximum values of the fundamental and the harmonics.

CHAPTER III

OPEN- AND CLOSED-CIRCUIT WINDINGS; BAR AND COIL WINDINGS; CONCENTRATED AND DISTRIBUTED WINDINGS; WHOLE- AND HALF-COILED WINDINGS; SPIRAL, LAP AND WAVE WINDINGS; SINGLE- AND POLYPHASE WINDINGS; POLE PITCH; COIL PITCH; PHASE SPREAD; BREADTH FACTOR; HARMONICS; PITCH FACTOR; EFFECT OF PITCH ON HARMONICS; EFFECT ON WAVE FORM OF DISTRIBUTING A WINDING; HARMONICS IN THREE-PHASE GENERATORS

Open- and Closed-circuit Windings.—All alternating-current windings may be divided into two general groups:

- I. Open-circuit windings.
- II. Closed-circuit windings.

An open-circuit winding, as its name signifies, is not closed on itself. In an open-circuit winding there is a continuous path through the conductors of each phase on the armature which terminates in two free ends.

A closed-circuit winding has a continuous path through the armature which re-enters on itself, forming a closed circuit. All closed-circuit windings have at least two parallel paths between their terminals.

All modern direct-current windings are closed-circuit windings. Either open- or closed-circuit windings may be employed for alternators but, except in a few special cases, open-circuit windings are better adapted for alternators and are universally used. Multipolar alternator armature windings may have two or more parallel paths through their armatures, but such windings are not re-entrant, *i.e.*, closed-circuit, windings. Windings with two parallel paths between terminals are called two-circuit windings or, in general, windings with two or more parallel paths between terminals are called multicircuit windings. Such windings are sometimes used for low-voltage alternators.

A continuous-current winding may be used for an alternator.

but an alternating-current winding, since it is not re-entrant, cannot be used for a direct-current generator.

Bar and Coil Windings.—Armature windings may be divided into two general classes according to the way in which the coils are placed in the slots, namely: bar windings and coil windings. In the former, insulated rectangular copper bars are laid in the

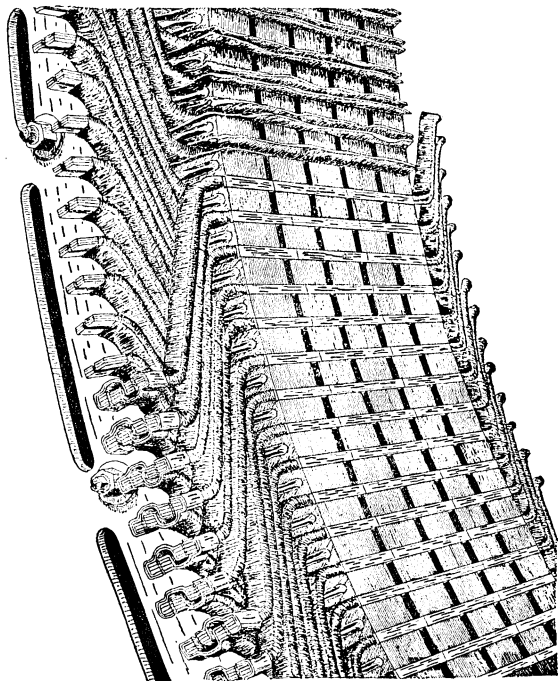

FIG. 18.

armature slots and are then suitably connected by brazing, welding or bolting. In the latter type of winding, coils of rectangular or of round insulated wire are wound on forms in lathes, are insulated and then placed in the slots. When closed or nearly closed slots are used, it is sometimes necessary to wind the coils by hand directly on the armature by threading the wire through the slots. Form-wound coils are more reliable and are generally used, except where nearly closed slots are required.

Whether bar or coil windings are employed, the slots must be properly insulated by press board, mica or other suitable material.

A bar wave winding with two bars per coil and four bars per slot is shown in Fig. 18. Fig. 19 shows two types of coils for coil-wound armatures. When the type of coil shown on the left is used, all the armature coils are the same size and shape irrespective of the phase they are in or their position on the armature. Two different shapes of coils are required for the other type of winding. Moreover, it does not permit as good bracing of the end connections as the first.

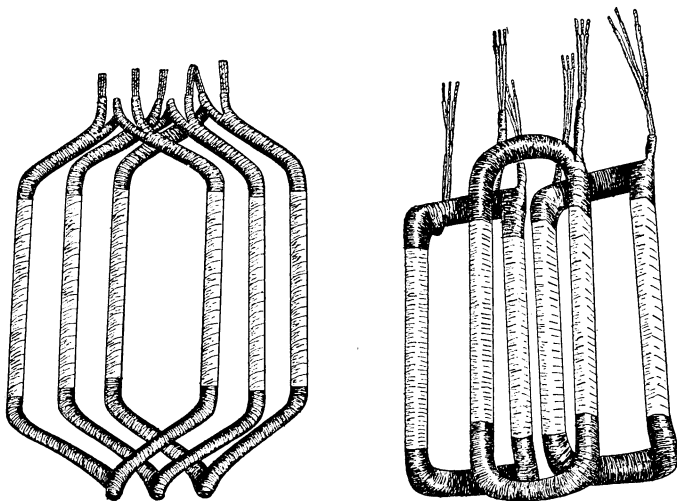

FIG. 19.

Concentrated and Distributed Windings.—Concentrated windings have all of the inductors of any one phase, which lie under a single pole, in a single slot. Better results can usually be obtained by distributing the inductors among several slots. Such windings are called distributed windings. They are completely distributed or partially distributed according as they are spread over the entire armature surface or over only a portion of it. Distributed windings diminish armature reactance and armature reaction, give a better wave form and a better distribution of the heating due to the armature copper loss than concentrated windings.

Whole- and Half-coiled Windings.—The one common requirement for all windings is that all conductors must be connected together in such a way that their electromotive forces shall assist. Fig. 20 shows a six-pole alternator with two inductors per pole. The short lines over the poles represent diagrammatically the armature inductors, and the arrows on these lines represent the direction of the electromotive forces induced in them for the clockwise rotation of the field. An inductor extending into the

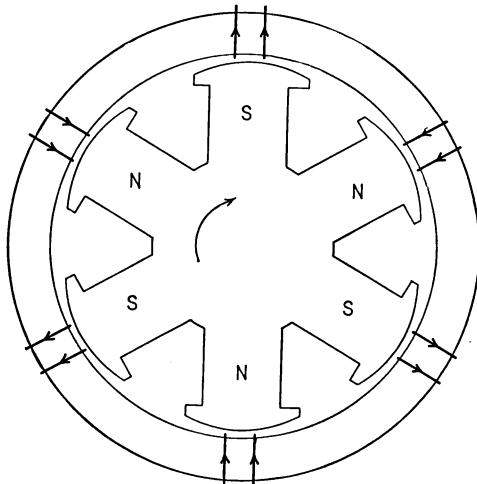

FIG. 20.

paper is represented by a line drawn radially outward. Each slot on the armature is assumed to contain two inductors. These are shown side by side in Fig. 20. They may be connected in two ways as illustrated by Figs. 21 and 22. Electrically the connections shown in Figs. 21 and 22 are identical. The lower halves of these figures represent the connections on the backs of the armatures as they would actually appear.

Fig. 21 represents what is known as a whole-coiled winding. Fig. 22 shows a half-coiled winding. Whole-coiled windings have as many coils per phase as there are poles. Half-coiled windings have only one coil per phase per pair of poles. The two turns per pair of poles shown in Fig. 22 would be in a single coil. The only real difference between the two types of winding lies

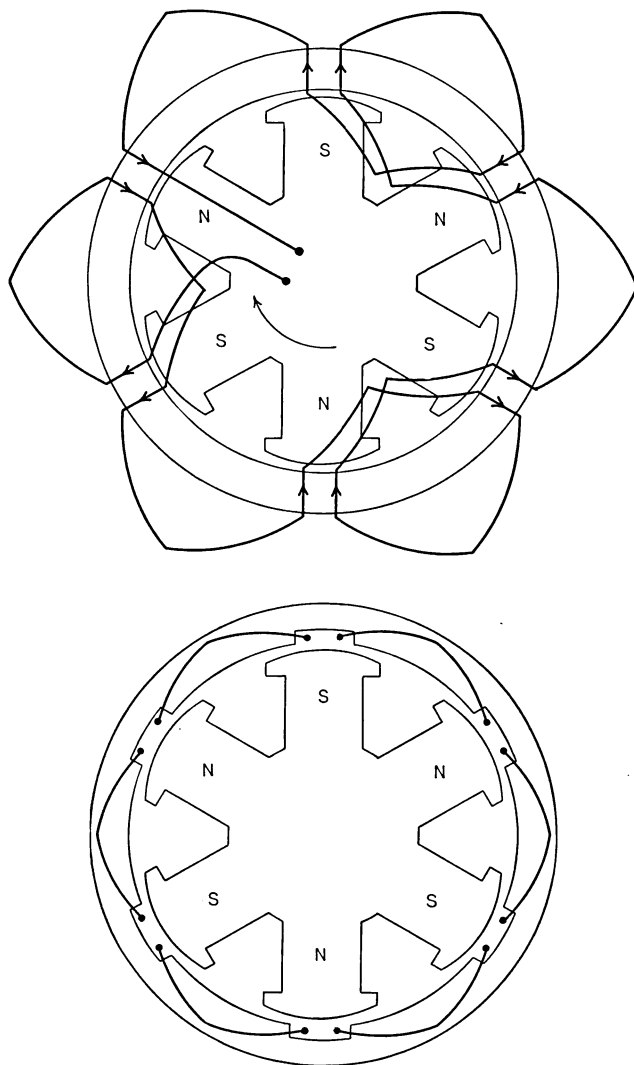

FIG. 21.

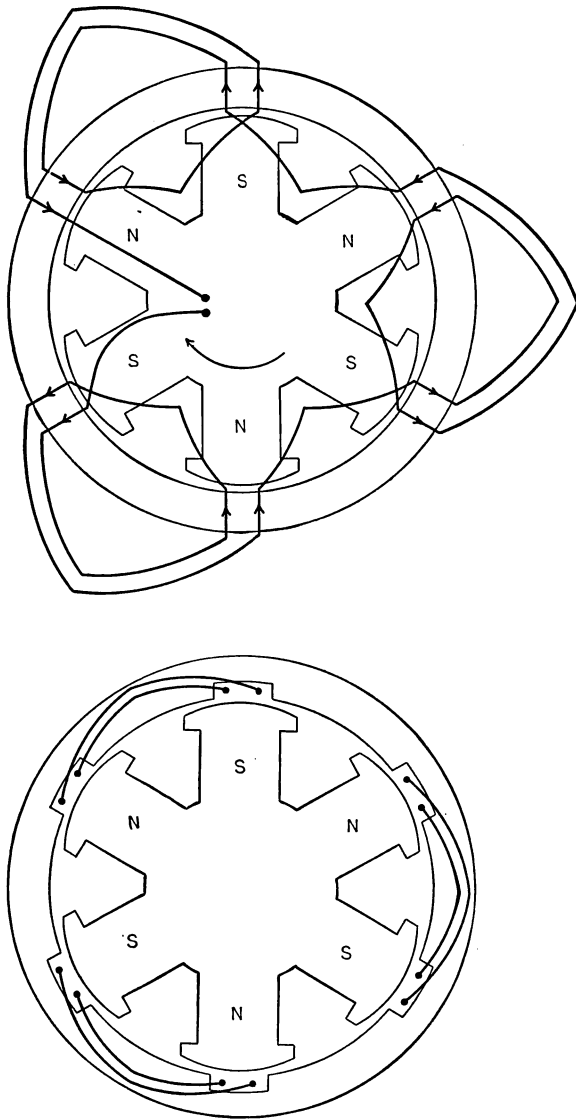

FIG. 22.

in the method of making the end connections between the inductors in the slots. The connections between the coils for a half-coiled winding are simpler than for a whole-coiled winding. When a half-coiled winding is used on a generator, the armature frame or yoke may be split into two or more sections for shipment without disturbing many end connections.

Spiral, Lap and Wave Windings.—When the windings are distributed they may be connected in three different ways giving what are known as:

- (a) Spiral windings.
- (b) Lap windings.
- (c) Wave or progressive windings.

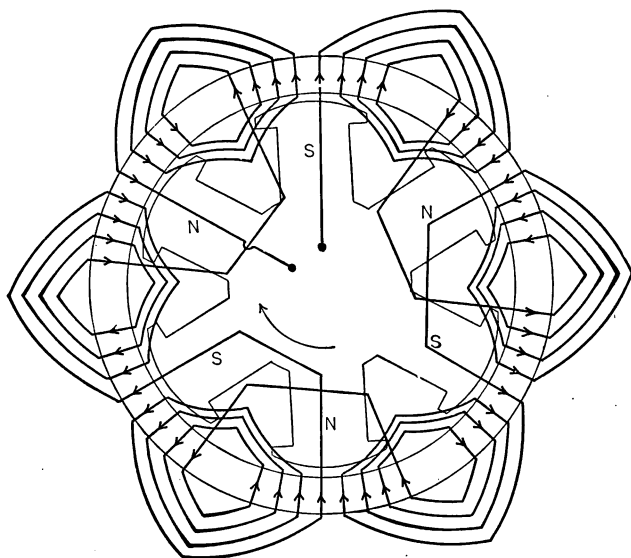

FIG. 23.

Lap and wave windings may also be used for concentrated windings. The difference between these three types of windings will be made clear by referring to Figs. 23, 24 and 25, which show respectively a spiral winding, a lap winding and a wave winding. All three figures show distributed single-phase windings with eight slots per pole.

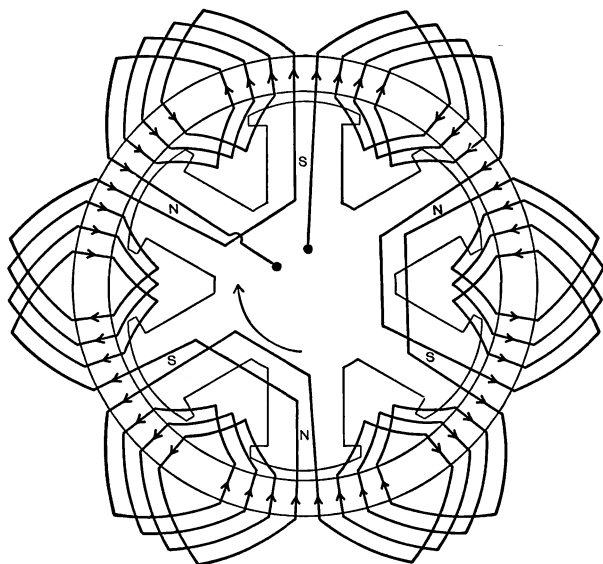

FIG. 24.

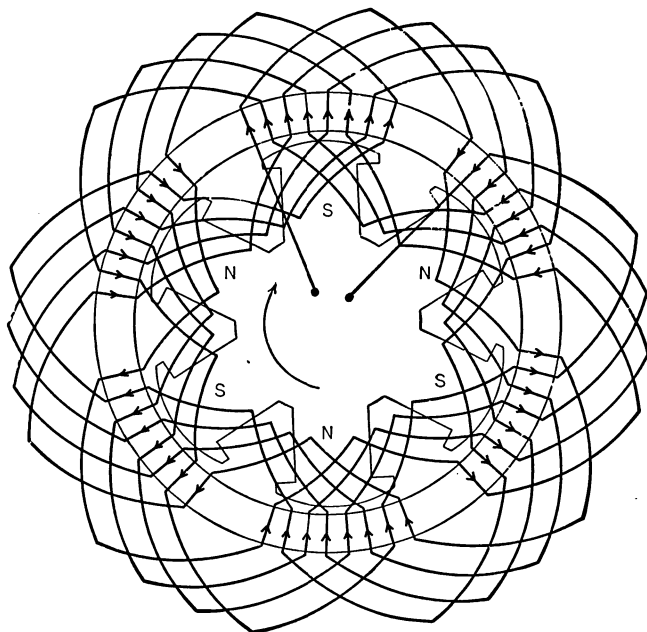

FIG. 25.

The lap winding lends itself better to the use of lathe-wound formed coils than the spiral winding as in the former all of the coils will be the same. If formed coils are used for a spiral winding, there will have to be as many different widths of coils, *i.e.*, coil pitches, as there are slots per pole per phase for a half-coil winding, but only one-half as many for a whole-coil winding.

Single- and Polyphase Windings.—A single-phase winding has only one group of inductors per pole. These may be in a single slot or in several slots according to whether the winding is concentrated or distributed. A polyphase winding may be considered to consist of a number of single-phase windings displaced by suitable angles from one another. The electrical space displacement between the single-phase elements must be the same as the phase differences between the voltages to be induced. For example, the corresponding elements of the winding of a three-phase alternator must be displaced 120 electrical space degrees from one another. Although the single-phase windings which make up the polyphase winding are independent of each other, the windings are always interconnected in either star or mesh. The number of leads brought out will be equal to the number of phases, except when star connection is used when an additional lead may be brought out from the common junction or neutral point of the phases. In the case of three-phase alternators, the star and mesh connections are, respectively, the Y and Δ connections. Most modern alternators are connected in Y . Y connection permits the neutral point to be grounded and gives a higher voltage between terminals for the same phase voltage than the Δ connection. It also gives a higher slot factor, *i.e.*, the ratio of copper to insulation for a given size slot is greater for a given thickness of insulation than for the Δ connection. High-voltage alternators are invariably Y -connected as with this connection the strain on the slot insulation is only $\frac{1}{\sqrt{3}}$ as great as

it would be with Δ connection for the same terminal voltage. When there is no consideration such as high voltage to determine whether Y or Δ connection should be used, the method of connecting the phases is sometimes fixed by the number of slots in the standard armature stampings which are available, the frequency, the voltage and the permissible range of flux density.

For the same voltage between terminals and line current, Y and Δ connections require the same amount of copper, but the Y connection requires fewer total turns than the Δ connection ($\frac{1}{\sqrt{3}} = 0.58$ as many), and since the thickness of insulation required on the wires depends upon the voltage and not upon their size, the ratio of space occupied in a slot by the copper to the space occupied by insulation will be greater for the Y than

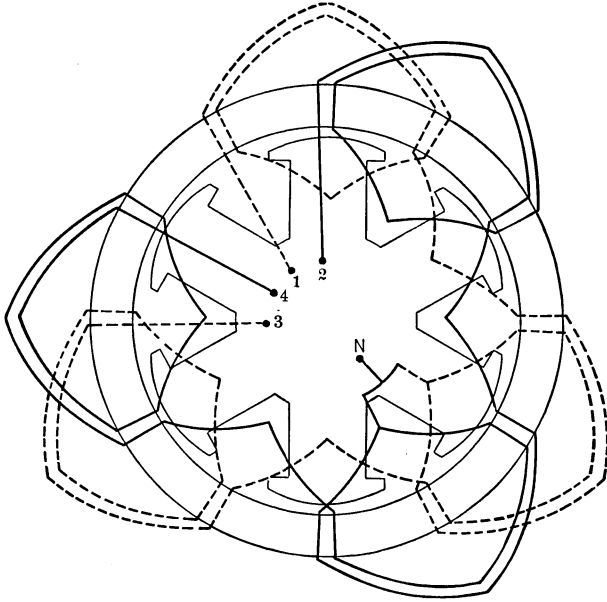

FIG. 26.

for the Δ connection. In other words, the slot factor of a Y -connected alternator will be higher than the slot factor of a Δ -connected alternator. Therefore, smaller slots can be used for Y connection than for Δ connection.

Fig. 26 shows a simple six-pole, two-phase half-coiled winding with two inductors per slot. Fig. 27 shows a similar three-phase winding. The phases 1, 2 and 3 of the three-phase winding are indicated by full lines, dashed-and-dotted lines and dotted lines respectively.

The arrangement of the coils of a three-phase alternator having one slot per pole per phase and a half-coiled winding is shown in Fig. 28. Fig. 29 shows an end view of a large turbo alternator and illustrates one of the most satisfactory methods of bracing the end connections to resist the severe stresses to which they are subjected at times of short-circuit (Chapter VIII).

Pole Pitch.—The pole pitch is the distance between the centers of adjacent north and south poles.

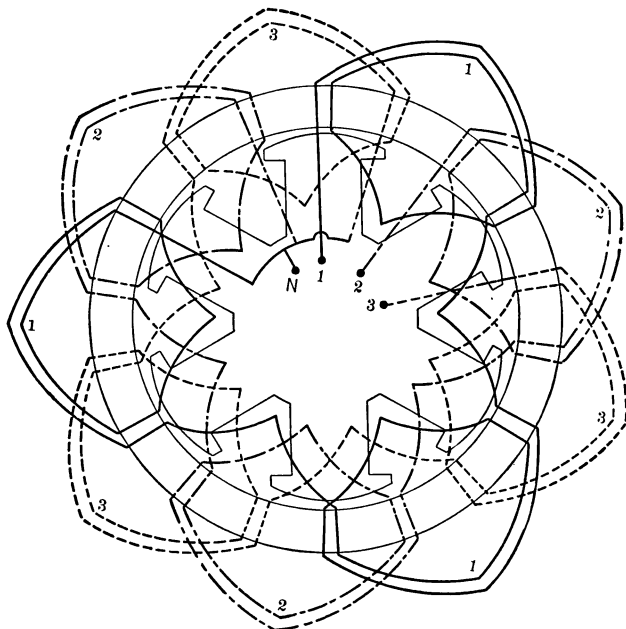

FIG. 27.

Coil Pitch.—The distance between the two sides of any armature coil is called the coil pitch. Coil pitch is usually expressed as a fraction of the pole pitch, but it is sometimes convenient to express it in electrical degrees or in slots. For example: a coil pitch of $\frac{2}{3}$ would be a pitch of 120 electrical degrees or, if there were twelve slots per pole, a pitch of eight slots. A winding having a coil pitch of less than 180 electrical degrees or unity is called a *fractional-pitch* winding. Since the two sides of a coil of a fractional-pitch winding do not lie under the centers of ad-

jacent poles at the same instant, the electromotive forces induced in them are out of phase. The voltage produced by a fractional-pitch winding is, therefore, less than that produced by a full-pitch winding having the same number of turns. Fractional-pitch windings are often used. They decrease the length of the end connections and thus the amount of copper required.

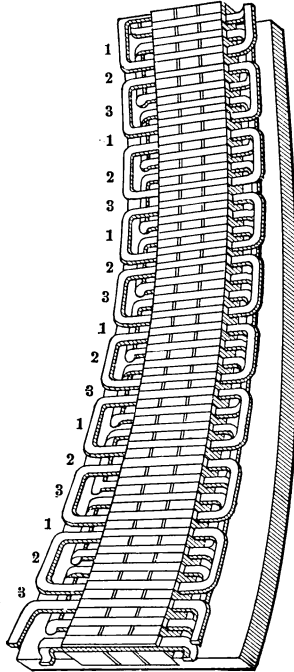

FIG. 28.

They also somewhat reduce the slot reactance and give a means of eliminating any one harmonic from the electromotive-force wave and reducing the others. They require a few more turns or a greater flux for the same electromotive force than a winding having a full pitch.

Phase Spread.—The phase spread of a winding is the percentage of the periphery of the armature over which the windings of a single phase are spread. For example: a single-phase winding which covers the entire surface of an armature has a spread of

unity. Phase spread may also be expressed in electrical degrees. A phase spread of unity is a phase spread of 180 degrees.

Breadth Factor.—The voltages induced in the separate coils of a distributed winding are not in exact phase and their resultant is, therefore, less than would be given by a concentrated winding

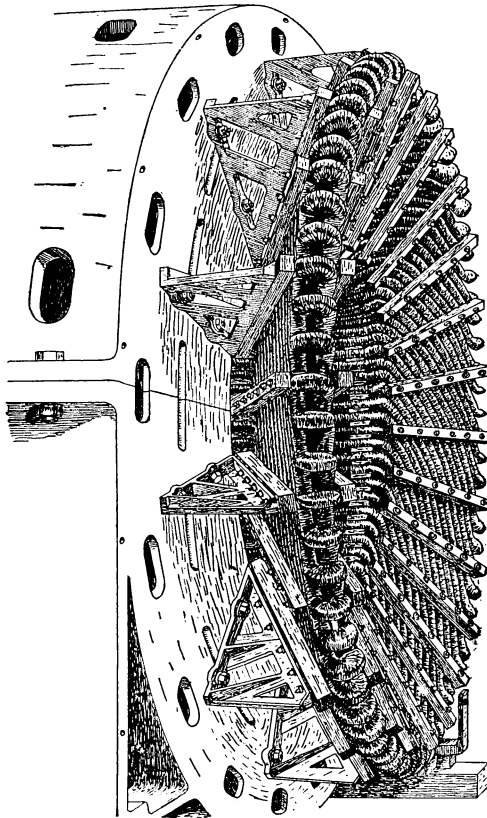

FIG. 29.

having the same number of turns. The ratio of the voltages produced by distributed and concentrated windings having the same number of turns is called the breadth factor. The breadth factor for any form of winding may be found by calculating the voltage induced in each turn or group of turns occupying a single pair of slots and then adding vectorially the voltages produced

in all pairs of slots over which the phase is distributed. The ratio of this voltage to the voltage which would be produced if all the turns were concentrated in a single pair of slots is the breadth factor. Consider a three-phase generator having six slots per pole, that is, two slots per pole per phase. Let N be the number of turns per coil. The voltage per coil is, equation (2), page 21,

$$E = 4.44Nf\phi_m 10^{-8}$$

The angle between adjacent slots is $\frac{180}{6} = 30$ electrical degrees. This is the phase angle between the voltages produced by the inductors in the two groups of coils. The sum of these two voltages is

$$\begin{aligned} E' &= 2E \cos \frac{30^\circ}{2} \\ &= 1.932E \end{aligned}$$

If all the turns were in the same pair of slots, the voltage would be

$$E'' = 2E$$

The breadth factor is, therefore,

$$\frac{E'}{E''} = \frac{1.932}{2} = 0.966$$

The breadth factor for a winding with n slots per pole per phase may be found as follows. Let α be the angle in electrical radians between adjacent slots of a winding having n slots per pole per phase and let Z be the inductors in series per slot. Assume a sinusoidal electromotive force.

The instantaneous electromotive force induced in the inductors of the first slot of the phase belt is

$$e_1 = ZE_m \sin \omega t$$

where E_m is the maximum electromotive force induced in an inductor.

The instantaneous electromotive force for the n slots of the phase belt is

$$e_n = ZE_m \left\{ \sin \omega t + \sin (\omega t + \alpha) + \sin (\omega t + 2\alpha) + \dots + \sin (\omega t + (n-1)\alpha) \right\}$$

The series by trigonometry is equal to

$$e_n = ZE_m \sin \left(\omega t + \frac{n-1}{2} \alpha \right) \sin \frac{n\alpha}{2} \operatorname{cosec} \frac{\alpha}{2}$$

The maximum value of this electromotive force may be found by determining the value of ωt which makes e_n a maximum and then substituting this value of ωt in the expression for e_n .

e_n will be a maximum when $\sin \left(\omega t + \frac{n-1}{2} \alpha \right)$ is a maximum.

$$\frac{d}{dt} \sin \left(\omega t + \frac{n-1}{2} \alpha \right) = 0$$

$$\omega \cos \left(\omega t + \frac{n-1}{2} \alpha \right) = 0$$

$$\omega t = \frac{\pi}{2} - \frac{n-1}{2} \alpha$$

Putting this value of ωt in the expression for e_n gives for the maximum value of e_n

$$e_{n(max.)} = ZE_m \frac{\sin \frac{n\alpha}{2}}{\sin \frac{\alpha}{2}}$$

If the inductors of the phase belt had all been concentrated in a single slot, the maximum value of e_n would have been

$$e'_{n(max.)} = nZE_m$$

The breadth factor is, therefore,

$$k_b = \frac{e_{n(max.)}}{e'_{n(max.)}} = \frac{\sin \frac{n\alpha}{2}}{n \sin \frac{\alpha}{2}} \tag{3}$$

The breadth factors for a few uniformly distributed windings assuming sinusoidal electromotive forces are given in Table I.

TABLE I

Number of slots	Breadth factors				
	Width of groups of slots in fractional parts of the pole pitch				
	¼	⅓	½	¾	Whole
2.....	0.980	0.966	0.924	0.866	0.707
3.....	0.977	0.960	0.911	0.844	0.666
4.....	0.976	0.958	0.906	0.836	0.653
Infinite.....	0.975	0.955	0.901	0.827	0.637

Harmonics.—Any single-valued periodic quantity may be expressed by a Fourier series as follows.

$$x = A_0 + A_1 \sin \omega t + B_1 \cos \omega t + A_2 \sin 2\omega t + B_2 \cos 2\omega t + A_3 \sin 3\omega t + B_3 \cos 3\omega t + \dots \quad (4)$$

Written with sine terms only, equation (4) reduces to

$$x = A_0 + C_1 \sin(\omega t + \alpha_1) + C_2 \sin(2\omega t + \alpha_2) + C_3 \sin(3\omega t + \alpha_3) + \dots \quad (5)$$

where the angles $\alpha_1, \alpha_2, \alpha_3$, etc., are the angles between the resultant harmonic and the original sine term.

$$C_1 = \sqrt{A_1^2 + B_1^2}$$

$$C_2 = \sqrt{A_2^2 + B_2^2}$$

etc., etc.

$$\alpha_1 = \cos^{-1} \frac{A_1}{C_1}$$

$$\alpha_2 = \cos^{-1} \frac{A_2}{C_2}$$

etc., etc.

Waves which have symmetrical positive and negative loops cannot contain even harmonics. This is evident from a con-

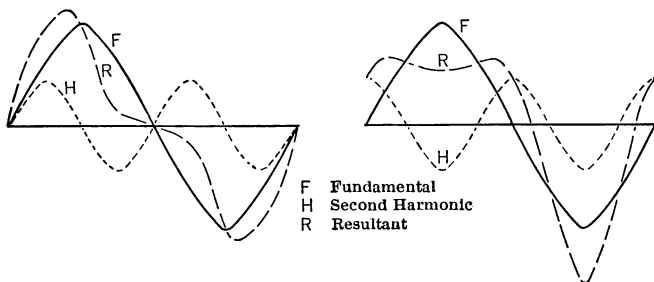

FIG. 30.

sideration of Fig. 30 which shows the resultant of a fundamental and second harmonic for two different phase relations between the fundamental and the harmonic.

No matter what the order of an even harmonic is, its phase with respect to the positive and negative loops of the fundamental wave is opposite. A little thought will make it clear that odd

harmonics will have the same phase with respect to the two halves of the fundamental wave and will, therefore, give rise to symmetrical resultant waves.

The conditions in properly designed alternators for the generation of the positive and the negative loops of the electromotive-force wave are the same, consequently the voltage and also the current waves of alternators do not as a rule contain even harmonics. The general expressions for the electromotive-force and current waves of an alternator are, therefore,

$$e = E_1 \sin(\omega t + \alpha_1) + E_3 \sin(3\omega t + \alpha_3) + E_5 \sin(5\omega t + \alpha_5) + \dots \quad (6)$$

and

$$i = I_1 \sin(\omega t + \alpha_1 - \theta_1) + I_3 \sin(3\omega t + \alpha_3 - \theta_3) + I_5 \sin(5\omega t + \alpha_5 - \theta_5) + \dots \quad (7)$$

where the E 's and I 's are the maximum values of the different harmonics and the θ 's are the angles of lag between the currents and voltages of the corresponding harmonics.

Pitch Factor.—The voltage generated in any single turn on the armature of an alternator is the vector difference of the voltages generated in the two inductors which form the active sides of the turn. With a full-pitch winding, these two voltages are in phase when considered around the coil.

In the case of a fractional-pitch winding, the active sides of the coil are less than 180 electrical degrees apart and the electromotive forces generated in them, therefore, will be out of phase. If ρ is the pitch expressed in electrical degrees, the difference in phase for the fundamental of the two voltages will be ρ . In general, since the displacement for any harmonic such as the n th must be n times the phase displacement for the fundamental, the difference in phase between the harmonics of any order, such as the n th, generated in the two active sides of any coil of a fractional-pitch winding will be $n\rho$.

Since the voltage in a coil is the vector difference of the voltages generated in its active sides, the voltage, E_n , of the n th harmonic generated in a coil is equal to

$$E_n = 2E'_n \sin \frac{n\rho}{2}$$

where E'_n is the value of the n th harmonic voltage in the coil side.

The pitch factor is the ratio of the voltage, E_n , induced in a fractional pitch winding to the voltage, $2 E'_n$ that would be induced if the winding had a full pitch. The magnitude of the pitch factor for any harmonic is

$$k_p = \sin \frac{n\rho}{2} \quad (8)$$

For odd harmonics, the sign and magnitude of the pitch factor is given in terms of pitch deficiency ($180 - \rho$) by

$$k_p = \cos \frac{n(180 - \rho)}{2}$$

Effect of Pitch on Harmonics.—Any harmonic may be eliminated from the voltage generated in an armature coil by choosing a pitch that will make the pitch factor zero for that harmonic. To eliminate the n th harmonic

$$k_p = \sin \frac{n\rho}{2} = 0 \text{ or } \rho = \frac{2q\pi}{n} \quad (9)$$

where q is any integer.

For example, to eliminate the fifth harmonic pitches of $\frac{2}{5}$, $\frac{4}{5}$, $\frac{6}{5}$, etc., could be used. Since any departure from full pitch diminishes the fundamental by an amount which increases progressively with the departure of the pitch from unity, in practice the shortened pitch which is nearest to unity, in this case $\frac{4}{5}$, would be used. Pitches which are greater than unity require more copper for the coil end connections than shortened pitches and possess no compensating advantage.

Eliminating any one harmonic from the voltage induced in the armature coils of an alternator not only eliminates that particular harmonic but also diminishes the fundamental and other harmonics, usually by different amounts, and changes the phase relations of the harmonics with respect to the fundamental. For example, let the voltage generated in the active side of an armature coil be

$$e = E_1 \sin \omega t + E_3 \sin 3\omega t + E_5 \sin 5\omega t + E_7 \sin 7\omega t$$

If a $\frac{2}{3}$ pitch is used, the resultant voltage generated in the coil will be

$$e = 1.73 E_1 \sin \omega t - 1.73 E_5 \sin 5\omega t - 1.73 E_7 \sin 7\omega t$$

A $\frac{5}{6}$ pitch is particularly satisfactory as it nearly cuts out both the fifth and seventh harmonics. It will be shown later that there can be no third harmonic or multiples of the third harmonic between the terminals of a three-phase, Y -connected generator. Therefore, by using a $\frac{5}{6}$ pitch and Y connection there can be no third, ninth or fifteenth harmonics and only a small fifth and seventh between

the line terminals. The first harmonic which can occur in any magnitude is the eleventh, and harmonics of as high order as this seldom are present in sufficient magnitude to have much effect on the wave form.

The magnitudes of the harmonics in fractional-pitch windings as compared with their magnitudes in a full-pitch winding having the same number of turns are given in Table II.

TABLE II

Pitch	Harmonic				
	1	3	5	7	11
$\frac{2}{3}$	0.866	0.000	0.866	0.866	0.866
$\frac{4}{5}$	0.951	0.588	0.000	0.588	0.951
$\frac{5}{6}$	0.966	0.707	0.259	0.259	0.966
$\frac{7}{8}$	0.975	0.782	0.434	0.000	0.782

The Effect on Wave Form of Distributing a Winding.—When a winding is distributed, that is, when it occupies more than one slot per pole per phase, the electromotive forces generated in the turns of a single phase, which occupy different pairs of slots, will be out of phase. For the fundamental of the voltage wave, this difference in phase will be equal to the angle between the two pairs of slots occupied by the two groups of turns. For the third harmonic it will be three times this angle; for the fifth, five times; for the seventh, seven times, the angle, of course, being measured in electrical degrees.

The general effect of distributing a winding is to smooth out the wave form by diminishing the amplitude of the harmonics with respect to the fundamental. This can be made clear by considering a specific case. Take, for example, a generator which has a distribution of flux in its air gap which gives an electromotive force containing a third and a fifth harmonic in each turn of the armature winding. Let the equation of this electromotive force be

$$e = E(\sin \omega t + \frac{1}{3} \sin 3\omega t + \frac{1}{5} \sin 5\omega t)$$

Let there be four turns per pole per phase.

If all four turns are placed in a single pair of slots the resultant electromotive force generated in them will be

$$e_r = E(4 \sin \omega t + 1.33 \sin 3\omega t + 0.8 \sin 5\omega t)$$

and the harmonics will have the following relative magnitudes:

$$1\text{st}:3\text{rd}:5\text{th} = 1:0.33:0.2$$

Suppose the four turns are distributed among four pairs of slots which are 15 degrees apart. This corresponds to the distribution of the armature winding of a three-phase alternator having four slots per pole per phase and gives a phase spread of 60 degrees.

Let e_1 , e_2 , e_3 and e_4 be the electromotive forces generated in the four turns referred to the center of the phase belt. Then

$$e_1 = E[\sin(\omega t - 22.5^\circ) + \frac{1}{3}\sin 3(\omega t - 22.5^\circ) + \frac{1}{5}\sin 5(\omega t - 22.5^\circ)]$$

$$e_2 = E[\sin(\omega t - 7.5^\circ) + \frac{1}{3}\sin 3(\omega t - 7.5^\circ) + \frac{1}{5}\sin 5(\omega t - 7.5^\circ)]$$

$$e_3 = E[\sin(\omega t + 7.5^\circ) + \frac{1}{3}\sin 3(\omega t + 7.5^\circ) + \frac{1}{5}\sin 5(\omega t + 7.5^\circ)]$$

$$e_4 = E[\sin(\omega t + 22.5^\circ) + \frac{1}{3}\sin 3(\omega t + 22.5^\circ) + \frac{1}{5}\sin 5(\omega t + 22.5^\circ)]$$

Adding these vectorially gives the resultant voltage e_r equal to

$$e_r = E(3.84 \sin \omega t + 0.869 \sin 3\omega t + 0.164 \sin 5\omega t)$$

The relative magnitudes of the harmonics in this resultant wave are

$$1\text{st}:3\text{rd}:5\text{th} = 1:0.226:0.043$$

With all four turns in the same pair of slots the root-mean-square voltage is

$$\begin{aligned} E_{r.m.s.} &= \frac{4E}{\sqrt{2}} \sqrt{(1)^2 + (\frac{1}{3})^2 + (\frac{1}{5})^2} \\ &= 4.28 \frac{E}{\sqrt{2}} \end{aligned}$$

With the turns distributed this voltage is

$$\begin{aligned} E_{r.m.s.}' &= \frac{E}{\sqrt{2}} \sqrt{(3.84)^2 + (0.869)^2 + (0.164)^2} \\ &= 3.94 \frac{E}{\sqrt{2}} \end{aligned}$$

Distributing the winding has diminished the voltage by about 10 per cent. Therefore either 10 per cent. more turns or 10 per cent. more flux will be required in this particular case for the same voltage. The disadvantage of increasing the flux or the turns is usually more than balanced by the smoothing out of the wave form by diminishing the harmonics. The distribution of the armature copper loss is also improved. In the particular ex-

ample just given, distributing the winding reduced the third harmonic about 30 per cent. and the fifth about 79 per cent.

Harmonics in Three-phase Generators.—There can be neither a third harmonic nor any multiple of the third harmonic in the voltages between the terminals of a three-phase generator, but such harmonics may exist between any one of the three terminals and the neutral point if the generator is *Y*-connected.

Let the phase voltages of a three-phase generator be given by

$$\begin{aligned}
 e_1 &= E_1 \sin \omega t + E_3 \sin 3\omega t + E_5 \sin 5\omega t + E_7 \sin 7\omega t + \dots \\
 e_2 &= E_1 \sin (\omega t - 120^\circ) + E_3 \sin 3(\omega t - 120^\circ) + \\
 &\quad E_5 \sin 5(\omega t - 120^\circ) + E_7 \sin 7(\omega t - 120^\circ) + \dots \\
 e_3 &= E_1 \sin (\omega t - 240^\circ) + E_3 \sin 3(\omega t - 240^\circ) + \\
 &\quad E_5 \sin 5(\omega t - 240^\circ) + E_7 \sin 7(\omega t - 240^\circ) + \dots
 \end{aligned}$$

The angular displacement between any harmonic of any one phase and the corresponding harmonic of phase one is given in Table III.

TABLE III

Phase	Displacement in electrical degrees				
	1st	3rd	5th	7th	9th
1.....	0	0	0	0	0
2.....	120	3(120) = 360 = 0	5(120) = 600 = 240	7(120) = 840 = 120	9(120) = 1080 = 0
3.....	240	3(240) = 720 = 0	5(240) = 1200 = 120	7(240) = 1680 = 240	9(240) = 2160 = 0

Referring to Table III, it will be seen that all of the third harmonics are in phase. The ninth harmonics are also in phase. In fact, all multiples of the third harmonic will be in phase. The fifth harmonics are 120 degrees apart, but they occur in inverted order, that is in the order 1, 3, 2. The seventh harmonics are 120 degrees apart and in natural order. In general, starting with the fifth harmonic and neglecting those harmonics which are in phase, the sequence in which the harmonics of any order occur in the three phases alternates from the order 1, 3, 2, to the order 1, 2, 3.

Consider a Y -connected generator. Fig. 31 represents a space-phase diagram of the connections of the phases of a Y -connected generator and a time-phase diagram of the voltages induced in them.

The voltages across the three pairs of terminals 1-2, 2-3 and 3-1 are

$$e_{12} = e_{10} + e_{02} = e_{10} - e_{20}$$

$$e_{23} = e_{20} + e_{03} = e_{20} - e_{30}$$

$$e_{31} = e_{30} + e_{01} = e_{30} - e_{10}$$

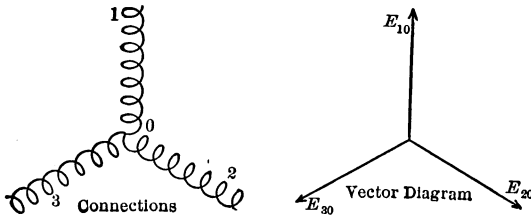

FIG. 31.

The voltage between any pair of terminals is, therefore, the vector difference of the phase voltages. Since the third harmonics and all the multiples of the third harmonics are in phase, they will cancel in the differences. Therefore, there cannot be any third harmonic or any multiple of it in the line or terminal voltage of a three-phase Y -connected alternator. The third harmonics and their multiples existing between the terminals and neutral point, however, will be in phase.

A study of the phase differences between the harmonics of the same order for the three phases will show that the voltages e_{12} , e_{23} and e_{31} of a Y -connected alternator when referred to e_{10} are:

$$e_{12} = \sqrt{3}E_1 \sin(\omega t + 30^\circ) + 0 + \sqrt{3}E_5 \sin 5\left(\omega t - \frac{30^\circ}{5}\right) + \sqrt{3}E_7 \sin 7\left(\omega t + \frac{30^\circ}{7}\right) + 0 + \dots$$

$$e_{23} = \sqrt{3}E_1 \sin(\omega t - 120^\circ + 30^\circ) + 0 + \sqrt{3}E_5 \sin 5\left(\omega t - 120^\circ - \frac{30^\circ}{5}\right) + \sqrt{3}E_7 \sin 7\left(\omega t - 120^\circ + \frac{30^\circ}{7}\right) + 0 + \dots$$

$$e_{31} = \sqrt{3}E_1 \sin(\omega t - 240^\circ + 30^\circ) + 0 + \\ \sqrt{3}E_5 \sin 5\left(\omega t - 240^\circ - \frac{30^\circ}{5}\right) + \\ \sqrt{3}E_7 \sin 7\left(\omega t - 240^\circ + \frac{30^\circ}{7}\right) + 0 + \dots$$

Consider the conditions existing in a Δ -connected alternator. The voltage acting around the closed delta is $e_{10} + e_{20} + e_{30}$. By referring to Table III it will be seen that the three components of the third harmonic voltage are in phase. They will, therefore, be short-circuited in the closed delta and cannot appear between the terminals of the alternator. The ninth and all other multiples of the third harmonic will also be short-circuited in the delta. The vector sum of all other harmonics, including the fundamental, will be zero when taken around the closed delta. The three line or terminal voltages of a Δ -connected alternator are:

$$e_{12} = E_1 \sin \omega t + 0 + E_5 \sin 5\omega t + E_7 \sin 7\omega t + 0 + \dots \\ e_{23} = E_1 \sin(\omega t - 120^\circ) + 0 + E_5 \sin 5(\omega t - 120^\circ) + \\ E_7 \sin 7(\omega t - 120^\circ) + 0 + \dots \\ e_{31} = E_1 \sin(\omega t - 240^\circ) + 0 + E_5 \sin 5(\omega t - 240^\circ) + \\ E_7 \sin 7(\omega t - 240^\circ) + 0 + \dots$$

Although the terminal voltages of an alternator when connected in Y and in Δ contain the same harmonics in the same relative magnitudes, the wave forms given by the two connections will be different, due to the phase displacement of 30 degrees which occurs in the harmonics of a Y -connected alternator.

The root-mean-square voltages given by the Y and Δ connections will be in the ratio of $\sqrt{3}$ to 1, but the maximum voltages will not be in this ratio since the phase relations between the harmonics are different for the two connections.

The effective value of the circulatory current caused by the third harmonic and its multiples in the armature of a Δ -connected generator is

$$\frac{1}{\sqrt{2}} \sqrt{\left(\frac{3E_3}{3z_3}\right)^2 + \left(\frac{3E_9}{3z_9}\right)^2 + \text{etc.}}$$

where the z 's are the effective impedances of the armature per phase for the different harmonics.

The effective reactance of the armature of an alternator for any harmonic will not be the effective or synchronous reactance of the armature for the fundamental multiplied by the order of the harmonic, but in general it will be considerably less than this on account of the difference between the armature reaction produced by the harmonics and the fundamental.

Δ connection is objectionable for alternators unless their wave forms are free from third harmonics and their multiples. If third harmonics are present in any great magnitude, there will be a large short-circuit current in the closed delta formed by the armature winding. This current combined with the load current may cause dangerous heating. Most modern alternators are Y -connected. The effect of the third harmonic in a Δ -connected generator is only one of several things which make Y connection preferable as a rule.

Harmonics Due to Slots.—Fig. 169, page 326, shows two positions of an armature core relative to a pole. The reluctance of the magnetic circuit is obviously less for the position shown at the right, where there are four slots over the pole, than for the position shown at the left where there are only three slots over the pole. The movement of the slots across the pole will therefore cause the pole flux to pulsate with a frequency of $2nf$ where n is the number of slots per pole and f is the normal frequency of the machine. If, however, the effective width of the pole

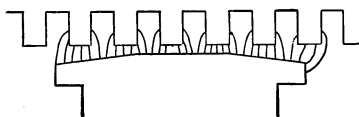

FIG. 31a.

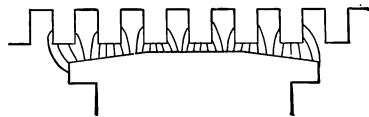

FIG. 31b.

should be equal to any whole number of times the width of a slot plus tooth, there will be no variation in the reluctance of the magnetic circuit as a whole due to the relative movement of the slots and poles. The effective width of the poles is slightly greater than the actual width on account of the fringing of the flux at the pole edges.

Due to the slots entering and leaving the polar region there will be a periodic variation in the fringing of the flux at the pole

tips which will cause an oscillation of the field axis with respect to the axis of the poles. Figs. 31a and 31b will make this clear.

For the relative position of the slots and field pole shown in Fig. 31a the fringing is greater at the right side of the pole than at the left. Fig. 31b shows the condition after a relative movement of the pole with respect to the slots equal approximately to the width of a slot. In this case the fringing is greater at the left side than at the right. This change in the fringing will produce an oscillation of the axis of the flux with respect to that of the poles at a frequency which equals $2nf$.

The slots also cause ripples in the flux wave (Fig. 60, page 125) which move across the pole faces. The movement of these ripples cannot cause any harmonics in the armature voltage since there is no relative movement between them and the armature inductors.

Either the variation in the magnitude of the field or in the position of its axis with respect to the poles may induce tooth harmonics in the armature voltage.

The electromotive force induced by either the oscillation or the variation in the field strength is of the form

$$\begin{aligned} e &= k(\sin 2n\omega t) \sin \omega t \\ &= \frac{1}{2}k[\cos (2n - 1)\omega t - \cos (2n + 1)\omega t] \end{aligned}$$

Either effect may therefore produce harmonics of two different frequencies in the armature winding, the order being $(2n - 1)$ and $(2n + 1)$.

CHAPTER IV

RATING; REGULATION; MAGNETOMOTIVE FORCES AND FLUXES CONCERNED IN THE OPERATION OF AN ALTERNATOR; ARMATURE REACTION; ARMATURE REACTION OF AN ALTERNATOR WITH NON-SALIENT POLES; ARMATURE REACTION OF AN ALTERNATOR WITH SALIENT POLES; ARMATURE LEAKAGE REACTANCE; EQUIVALENT LEAKAGE REACTANCE; EFFECTIVE RESISTANCE; FACTORS WHICH INFLUENCE THE EFFECT AND MAGNITUDE OF ARMATURE REACTION, ARMATURE LEAKAGE REACTANCE AND EFFECTIVE RESISTANCE; CONDITIONS FOR BEST REGULATION; SINGLE-PHASE RATING

Rating.—The maximum output of any alternator is limited by its mechanical strength, by the temperature of its parts produced by its losses, and by its voltage regulation. Usually the limit of output is fixed by the temperature.

The maximum voltage any alternator can give continuously depends upon the permissible flux per pole. The armature copper loss limits the maximum safe current. The kilowatt output depends upon the voltage, the current, and the power factor, but the core and copper losses and, therefore, the temperatures of the parts of an alternator depend upon the voltage and current and are nearly independent of the power factor. For this reason, alternators are rated on their kilovolt-ampere output and not upon their kilowatt output.

It is customary at present to rate alternators so that the maximum rise in temperature of their parts above a specified ambient temperature, *i.e.*, temperature of the surroundings, shall not exceed a certain definite number of degrees after a full-load run of sufficient duration for constant temperature conditions to have been reached. In addition, generators are usually designed to carry a 25 per cent. overload for 1 hour immediately following the continuous full-load run without an additional rise in temperature of more than a specified number of degrees. The

ambient temperature of reference recommended by the American Institute of Electrical Engineers is 40°C. The permissible maximum temperature rise in any part of an alternator depends upon the type of insulation used and upon the ambient temperature in which the alternator operates. It may be found from the limiting temperatures for different classes of insulation given on page 19 by subtracting the ambient temperature.

There is a growing feeling among engineers that all electrical apparatus should have for its rating the maximum kilovolt-ampere output it is capable of giving continuously without injury, instead of a full-load rating with a provision for an overload. Such maximum ratings are already in use for large turbo alternators.

Regulation.—The regulation of an alternator is the percentage rise in voltage, under the conditions of constant excitation and frequency, when the rated kilovolt-ampere load is removed. The change in voltage produced under this condition depends not only upon the magnitude of the load and the constants of the alternator, but also upon the power factor of the load. The regulation will be positive for both a non-inductive and an inductive load since both of these cause a rise in voltage when they are removed. A capacity load, on the other hand, may, if the angle of lead is sufficiently great, cause a fall in voltage instead of a rise. Under this condition the regulation will be negative. The inherent regulation is the regulation on full non-inductive load.

The regulation of an alternator depends upon four factors, namely:

- I. Armature reaction.
- II. Armature reactance.
- III. Armature effective resistance.
- IV. The change in the pole leakage with change in load.

Some of the four factors produce similar effects and for this reason they are combined in certain approximate methods for determining regulation. The relative magnitudes of the effects produced upon the terminal voltage of an alternator by these four factors depend not only upon the magnitudes of the factors, but also upon the power factor of the load. At 100 per cent. power factor with respect to the generated voltage, armature re-

action and reactance have a minimum effect upon the terminal voltage. Their maximum effect occurs at zero power factor. Just the opposite is true in regard to the effect produced by resistance. The actual magnitudes of reaction, reactance and resistance are fixed by the design and may be varied over quite wide limits, but considering merely the component change in voltage produced by each when acting separately, the magnitudes of their effects are usually in the order named.

Magnetomotive Forces and Fluxes Concerned in the Operation of an Alternator.—There are two distinct magnetomotive forces and three component fluxes to be considered in the operation of any alternator. The two magnetomotive forces are: (a) the magnetomotive force of the impressed field; (b) the magnetomotive force due to the armature current, *i.e.*, the armature reaction. Although both of these magnetomotive forces may be expressed either in ampere-turns per pole or per pair of poles, it is usually more convenient, especially when dealing with multipolar alternators, to express them in ampere-turns per pole.

The three component fluxes are: (a) the flux which is common or mutual to the armature and the field, this is the air-gap flux; (b) that portion of the total armature flux which links only with the armature inductors; and (c) the field leakage flux. This last is the portion of the field flux which passes between adjacent north and south poles without entering the armature. The ratio of the maximum flux in a pole to the portion of that flux which enters the armature is called the leakage coefficient or the leakage factor of the field. This coefficient varies from about 1.15 to 1.25 according to the design of the alternator. If the leakage coefficient were constant and independent of the load, the field leakage would produce no effect on the regulation of an alternator. The field leakage is inversely proportional to the reluctance of the path of the stray field and is directly proportional to the magnetic potential between the poles. The latter is made up of two parts: one, the drop in the magnetic potential necessary to force the flux through the armature and the air gap; the other, the opposing ampere-turns of armature reaction.

Armature Reaction.—When a synchronous generator operates at no load, the only magnetomotive force acting is that of the field winding. The flux produced by this winding will depend

only upon the current it carries, the number of turns and their arrangement, and the total reluctance of the path through which the magnetomotive force acts. The distribution of the air-gap flux will depend chiefly upon the shape of the pole shoe, except in cases where the cylindrical or drum type of field is used. In these latter, the distribution of the field winding will determine the distribution of the air-gap flux.

When load is applied to an alternator, the magnetomotive force of the armature current will modify the flux produced by the field winding. The effect of the armature magnetomotive force, or armature reaction, will depend not only upon the arrangement of the armature winding, the current it carries and the reluctance of the magnetic circuit, but also upon the power factor of the load.

Neglecting field distortion, the voltage generated in any coil or turn on the armature of a single-phase alternator will have its maximum value when the center of the coil lies midway between two adjacent poles. It will be zero when the center of the coil is directly opposite the center of a pole. If the power factor is zero with respect to the voltage produced by the air-gap flux, the maximum current will occur when the voltage is zero or when the coil is directly opposite a pole. Under this condition the axis of the magnetic circuit for the armature reaction coincides with the axis of the magnetic circuit for the field winding, and the resultant magnetomotive force acting to produce the field flux will be the algebraic sum of the magnetomotive forces of armature reaction and field excitation. Under this condition the armature reaction will either strengthen or weaken the field without producing distortion. The armature reaction caused by a lagging current will oppose the magnetomotive force of the field winding and will weaken the field. A leading armature current strengthens the field.

If, instead of the coil lying with its center opposite a pole when the current in it is a maximum, it lies with its center midway between two poles, it will cover half of two adjacent poles (a full-pitch winding is assumed) and will produce a demagnetizing action on half of one pole and a magnetizing action on half of the other. It follows that one-half of each pole is strengthened and the other half is weakened by the action of the armature

current. These two effects will be equal under the conditions assumed and the resultant action, therefore, produces a distortion in the flux distribution without changing the total strength of the field. The application of the cork-screw rule to the direction of the current carried by the armature coils will show that the trailing pole tips are strengthened and the leading pole tips are weakened by an in phase armature current. The effect is merely a shift in the flux from the leading pole tip to the trailing pole tip. The condition just described, *i.e.*, with the center of the armature coil midway between two poles when the current in it is a maximum, corresponds approximately to unit power factor with respect to the terminal voltage.

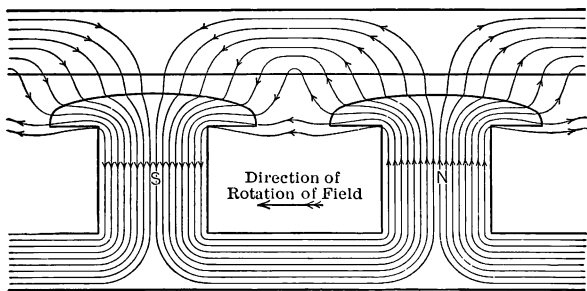

FIG. 32.

The approximate distributions of the flux at the instant when the armature current is a maximum for a reactive load of zero power factor and a power factor of unity are shown in Figs. 33 and 34 respectively. Fig. 32 shows the distribution at no load.

In the preceding discussion only the instant when the current is a maximum was considered. While the field is moving through a distance corresponding to 360 electrical degrees, the current in any armature coil as *ab*, Fig. 34, will go through a complete cycle and consequently the value of the total flux from a pole and its distribution will also go through a complete cycle. The average distribution of flux, however, will be about the same as when the current passes through its maximum value. Such a variation of the flux does not occur in the case of a polyphase alternator which carries a balanced load, since the armature reaction of such an alternator under such conditions is fixed in

magnitude and in direction with respect to the poles. The effect is the same as occurs in a single-phase alternator at the instant when the current passes through its maximum value.

To sum up, the general effect of armature reaction is as follows: with a non-inductive load, it distorts the field without appreciably changing the total field flux; with an inductive load of zero power factor, it weakens the field without distorting it; and with a load having a power factor between unity and zero, it both distorts the field and modifies its strength.

In addition to the general distortion of the field which has been so far considered, there will be a local distortion in the neighbor-

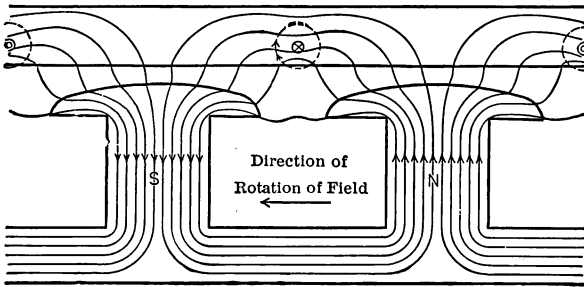

FIG. 33.

hood of each inductor. This distortion is limited to the region about the slots and to the air gap and does not extend to any depth into the pole faces. It is equivalent to a little ripple in the flux about each inductor and may be considered to be due to the superposition upon the main field of local fluxes which surround the armature inductors. These local fluxes are indicated by the dotted lines in Figs. 33 and 34. Although the local fluxes have no real existence except about the end connections of the coils, it is convenient to consider them separately as components of the main flux. They are alternating fluxes and are very nearly in time phase with the currents which cause them. They are the so-called leakage fluxes and give rise to a voltage of self-induction in the inductors with which they link. This voltage will alternate with the same frequency as the armature current and will lag 90 degrees behind that current. The reactance corresponding to this voltage of self-induction is the so-

called leakage or slot reactance of an alternator. More will be said of this under reactance.

A knowledge of armature reaction is necessary in order to pre-determine the regulation of an alternator and also to determine the number of field ampere-turns required at full load to maintain the rated voltage at different power factors. In the case of alternators with salient or projecting poles, such as are illustrated in Figs. 32, 33 and 34, armature reaction produces a distortion of the air-gap flux except when the power factor is zero, a condition which is impossible in practice and which is not even approached under ordinary operating conditions.

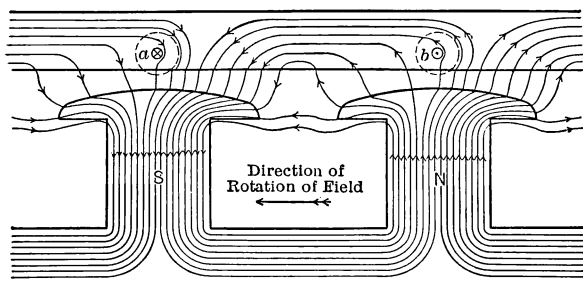

FIG. 34.

The distortion of the air-gap flux which takes place in an alternator with salient poles is caused almost entirely by the difference between the reluctance of the magnetic circuits for the armature reaction and the impressed field. Except when the power factor of the load is zero, the magnetomotive forces of the field and armature do not act along the same line. They are not in space phase and the axis of their resultant will not coincide with the axis of either. Since flux always distributes itself so as to follow the path of minimum reluctance, the flux caused by the combined action of the magnetomotive forces of the armature and field currents will still cling to the poles, but it will be crowded toward one side instead of being symmetrical about their axes. In the case of alternators with non-salient poles, however, the reluctance of the magnetic circuit for armature reaction is constant and independent of the power factor and is equal to the reluctance of the magnetic circuit for the impressed field. Under

this condition, there will be no distortion of the magnetic field under load provided the field and armature windings each give a sine distribution of magnetic potential in the air gap. This condition cannot be fulfilled exactly in practice.

Armature Reaction of an Alternator with Non-salient Poles.—

The armature reaction of an alternator with non-salient poles will first be considered. A sinusoidal current wave and a distributed armature winding will be assumed. Under this condition, the space distribution of the magnetic potential in the air gap due to the armature current will be nearly sinusoidal and will be so assumed. The effect of the slots on the armature and the field core will be neglected. Their presence will in reality produce little ripples in the wave of flux distribution.

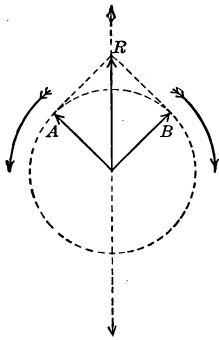

FIG. 35.

Under the conditions assumed, the armature reaction of a single-phase alternator will be sinusoidal with respect to time and will oscillate along an axis which is fixed in space with respect to the armature.

Any simple oscillating vector which varies with time according to a sine law can be resolved into two oppositely rotating vectors, each with a maximum value equal to one-half of the maximum value of the vector they replace and having the same period. An inspection of Fig. 35 should make this clear. The vertical dotted line on this figure represents the line along which the simple vector oscillates. *A* and *B* are the two oppositely rotating vectors. Their resultant, *R*, will be equal at every instant to the original vector and will lie along its axis.

Consider the armature reaction of a single-phase alternator to be resolved into two oppositely revolving vectors. Both of these vectors will rotate at synchronous speed with respect to the armature, one right-handedly, the other left-handedly. One of these vectors will rotate in the same direction as the field and will be stationary with respect to it.

Let N be the effective number of armature turns per pole and let I_m be the maximum armature current. The value of the

component of armature reaction which is fixed in direction with respect to the field is $\frac{1}{2}NI_m$ per pole. Replacing I_m by its root-mean-square value gives

$$A = 0.707NI \quad (10)$$

where I is the root-mean-square value of the current. The other component rotates at twice synchronous speed with respect to the poles and will set up in them a double-frequency or second-harmonic flux. This double-frequency component of the field flux in combination with the rotation of the field induces a third-harmonic voltage in the armature turns which will be present across the terminals of the alternator unless this double frequency component of the flux is eliminated by the reaction of currents in a damping winding in the pole faces similar to the damping winding for a synchronous motor. (See page 318.)

The voltage generated in any armature turn is

$$e = k\varphi \sin \omega t$$

where k is a constant and φ is the pole flux. Ordinarily φ is constant for any given excitation and load. If it varies with time, it must be inserted in the formula for the electromotive force as a function of the time. Assume the double-frequency flux variation due to armature reaction to be sinusoidal.

Then if $\varphi = \varphi_m \sin 2\omega t$ is the value of this flux at each instant, the electromotive force induced by it in the armature is

$$\begin{aligned} e &= k\varphi_m \sin 2\omega t \sin \omega t \\ &= \frac{1}{2}k\varphi_m \{ \cos \omega t - \cos 3\omega t \} \end{aligned}$$

The double-frequency component of the flux, therefore, produces voltages of both fundamental and triple frequency in each armature turn. The actual variation in the flux produced by armature reaction in the poles of a single-phase alternator will be very much reduced by the self-induction of the field winding, by eddy currents in the poles and by any short-circuited damping winding there may be on the field structure.

A single-phase alternator is always provided with a damping winding or damper in its pole faces. This damper is like those used on all synchronous motors. It consists of copper bars inserted in holes punched in the pole faces and short-circuited by bolting or welding copper straps to the ends of the bars. A

damping winding is illustrated in Fig. 168, page 319, under "Synchronous Motors." The double-frequency flux generates currents in the damper which, according to the law of Lenz, oppose the change in flux producing them. These currents will very nearly damp out the flux variation.

If the armature current is in phase with the voltage produced by the air-gap flux, the axis of the component of the armature reaction which is fixed with respect to the field will lie midway between two poles. If the lag of the current behind the voltage is 90 degrees, the axis of this component field will be along the axis of the poles. In general, the space angle between the axes of the resultant air-gap flux and armature reaction is equal to 90 degrees plus the angle of lag between the current and the voltage produced by the air-gap flux. An angle of lead is equivalent to a negative angle of lag.

The effective number of armature turns, N , used in formula (10), page 59, is the actual number of armature turns per pole multiplied by a factor which is equal to the product of the breadth and pitch factors of the winding. Some breadth and pitch factors are given in Tables I and II, pages 41 and 45.

In the case of a polyphase alternator, each phase may be treated like the one phase of a single-phase alternator. Consequently each will produce a fixed reaction on the field poles which is equal to $0.707NI$, where N is the effective turns per phase and I is the phase current, *i.e.*, the current carried by the conductors. Besides this fixed reaction, each phase will also produce a double-frequency reaction on the poles. The fixed part of the reactions of all phases on any pole will lie along the same axis and may be added directly. If the load is balanced, the total reaction becomes

$$0.707NI_n$$

where n is the number of phases. The number of effective turns per pole per phase multiplied by the number of phases is equal to the total number of effective armature turns per pole. Therefore, the armature reaction of any alternator carrying a balanced load will be given by formula (10), page 59, provided N is taken as the total effective turns per pole in all phases.

The variable or double-frequency reactions of all the phases will neutralize and be zero for a balanced load. For example, take a three-phase alternator. The current waves of the three phases differ in phase by 120 degrees. When referred to phase one, their phase differences are 0, 120 and 240. The phase relations between the double-frequency reactions produced by the three phases are 0, 2 (120) and 2(240), which are equivalent to 0, 240 and 120. Since the vector sum of three equal vectors which differ by 120 degrees is zero, the variable parts of the reactions of the three phases of a three-phase alternator carrying a balanced load will neutralize each other. In the case of a four-phase alternator, the phase relations between the double-frequency reactions are 0, 2(90), 2(180) and 2(270), which are equivalent to 0, 180, 0 and 180. The vector sum of these is obviously zero. Since the variable components of the armature reaction neutralize, the armature reaction of a polyphase alternator which has non-salient poles and which carries a balanced load is fixed in direction and in magnitude with respect to the poles. This assumes that the magnetomotive force of each phase is sinusoidal in its distribution. It will have approximately this distribution in the case of an alternator with a distributed armature winding when the current wave is sinusoidal.

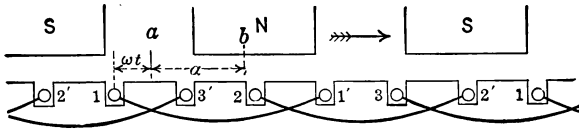

FIG. 36.

The effect of the armature reaction of a polyphase alternator may be explained in another way. Let Fig. 36 represent the field and armature of a three-phase alternator developed. The armature coils for the three phases are 1-1', 2-2' and 3-3'. The poles are shown as if they were salient merely to indicate their positions.

Take a reference point, a , at the zero point of the resultant field. This would be midway between two poles if it were not for armature reaction. The currents carried by each of the three phases, referred to a as a reference point from which to measure time, are $I_m \sin (\omega t - \theta)$, $I_m \sin (\omega t - 120^\circ - \theta)$ and

$I_m \sin(\omega t - 240^\circ - \theta)$, where θ is the angle of lag of the currents behind their corresponding voltages.

Assume that the space distribution of the magnetomotive force due to any phase is sinusoidal. It would have approximately this distribution with a distributed armature winding. Then, if A is the maximum magnetomotive force through a coil per unit angle, the average magnetomotive force is

$$\frac{1}{\pi} \int_0^\pi A \sin x \, dx = \frac{2}{\pi} A$$

The maximum is, therefore, $\frac{\pi}{2}$ of the average for a sinusoidal distribution. Let N and i be, respectively, the effective armature turns per pole per phase and i the current they carry. Then the maximum value of the magnetomotive force through the coil produced by the current i is $\frac{\pi}{2} Ni$.

The magnetomotive force due to any one phase at a point b in the air gap will vary on account of the variation in the current and also on account of the rotation of the field. If, for the moment, the currents in the phases are assumed constant and equal to I_1, I_2 and I_3 , the magnetomotive force at any point, b , at any instant due to all three phases would be

$$\frac{\pi}{2} \left\{ NI_1 \sin(\alpha + \omega t) + NI_2 \sin[\alpha + (\omega t - 120^\circ)] + NI_3 \sin[\alpha + (\omega t - 240^\circ)] \right\}$$

Putting the actual values of the currents in place of I_1, I_2 and I_3 gives for the magnetomotive force at the point b

$$\frac{\pi}{2} \left\{ NI_m \sin(\omega t - \theta) \sin(\alpha + \omega t) + NI_m \sin(\omega t - 120^\circ - \theta) \sin[\alpha + (\omega t - 120^\circ)] + NI_m \sin(\omega t - 240^\circ - \theta) \sin[\alpha + (\omega t - 240^\circ)] \right\} \quad (11)$$

Remembering that

$$\sin x \sin y = \frac{1}{2} \{ \cos(y - x) - \cos(y + x) \}$$

equation (11) may be reduced to

$$\frac{\pi}{4} NI_m \left\{ \cos(\alpha + \theta) - \cos(2\omega t + \alpha - \theta) + \cos(\alpha + \theta) - \cos(2\omega t + \alpha - \theta - 240^\circ) + \cos(\alpha + \theta) - \cos(2\omega t + \alpha - \theta - 480^\circ) \right\}$$

The three terms involving $2\omega t$ are three second harmonics which differ in phase by 120 degrees. Their vector sum is, therefore, zero and equation (11) reduces to

$$\frac{3\pi}{4} NI_m \cos(\alpha + \theta) \quad (12)$$

This is entirely independent of time and varies only with the position of the point b in space. Its maximum value will occur when b is at such a distance from a that $\alpha = -\theta$. The maximum value of the reaction is $\frac{3\pi}{4} NI_m$ and the average value per pole is $\frac{2}{\pi}$ of this or $\frac{3}{2} NI_m$. Replacing I_m by its root-mean-square value and letting N be the total effective turns on the armature per pole, this reduces to $0.707NI$ which is the same as the expression previously found.

When the distribution of a magnetomotive force is sinusoidal, its maximum value and, therefore, the vector representing it lie midway between its two zero points. From equation (12) it is obvious that the maximum value of the magnetomotive force of armature reaction lies at a distance from the reference point, a , which is equal to the angle of lag, θ , of the current behind the voltage produced by the air-gap flux due to the resultant field. With an angle of lag of 90 degrees, the vector representing the magnetomotive force of armature reaction will lie along the field axis, and, since the expression for the armature reaction is negative, it will oppose the magnetomotive force of the impressed field. Therefore, as has already been shown, a lagging armature current weakens the field.

Although armature reaction is fixed in direction and in magnitude with respect to the field and is a space vector with respect to the field, it revolves at synchronous speed with respect to the armature and is a time vector when considered with respect to the armature coils. The maximum voltage occurs in any coil on the armature when its center is displaced 90 degrees from the field axis. The maximum current in any armature coil occurs after the coil has been further displaced by an angle θ . The maximum current in the coil and the maximum magnetomotive force through it due to armature reaction, therefore, occur at

the same instant. Considering armature reaction as a time vector, armature reaction and armature current are in phase.

Armature Reaction of an Alternator with Salient Poles.—What has been said in regard to the armature reaction of alternators with non-salient poles does not apply, except approximately, to machines with salient poles. In the latter case, the component of the field which is caused by armature reaction varies with the power factor as well as with the current.

Figs. 37, 38 and 39 show the distribution of the component fluxes caused by the impressed field and armature reaction and

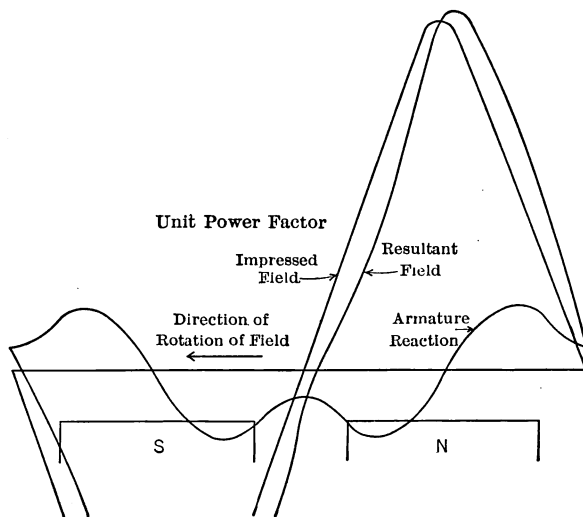

FIG. 37.

also the resultant flux in a small, three-phase, Y-connected alternator with a distributed armature winding and with salient poles. The first figure is for unit power factor; the second, for 0.09 power factor; and the third, for 0.7 power factor. Compare Figs. 37 and 38 with Figs. 34 and 33.

Although the armature reaction of an alternator with salient poles cannot correctly be considered a vector, it is quite customary to so consider it on vector diagrams. When so considered, the constant 0.707 is sometimes modified. Even when 0.707 is used, the regulation found from the vector diagram is often approximately correct.

In order to represent more nearly the actual conditions existing in alternators with salient poles when calculating their

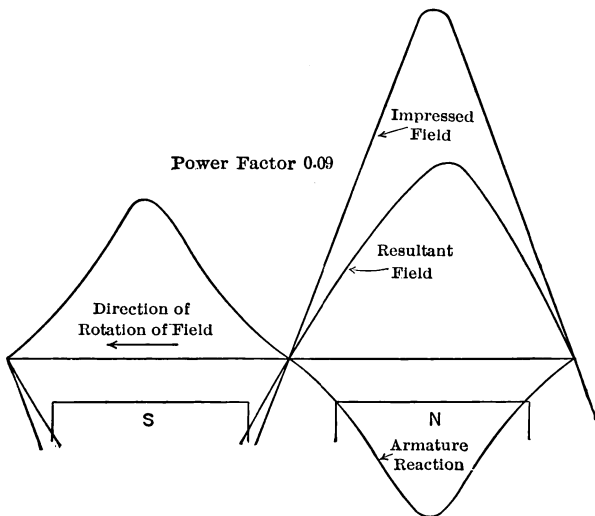

FIG. 38.

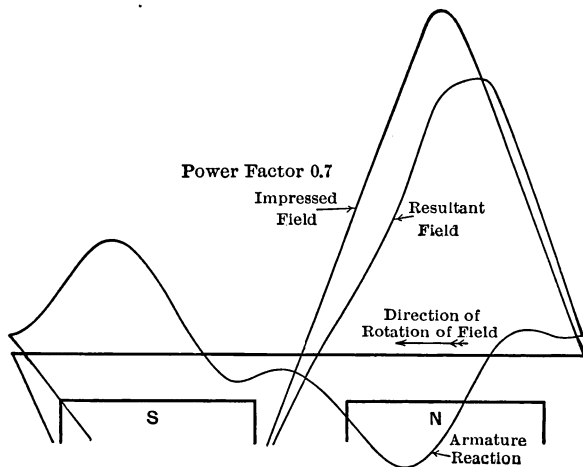

FIG. 39.

regulation, armature reaction is sometimes divided into two quadrature components: one along the field axis, and the other

at right angles to it or midway between the poles. By using the proper constant with each of these two components very satisfactory results can be obtained. This method was suggested by André Blondel and is known as the two-reaction or the double-reaction method (see page 106). Under ordinary conditions, the cross-magnetizing component has relatively little effect on the voltage. For the usual ratios of pole arc to pole pitch the coefficient for the demagnetizing component of the armature reaction is about 0.7.

Armature Leakage Reactance.—The armature leakage flux of an alternator produces a voltage of self-induction in the armature inductors which is very nearly 90 degrees behind the current. The equivalent reactance corresponding to this voltage added to the reactance of the end turns of the armature coils gives the leakage reactance of the armature.

For convenience in calculation, armature leakage reactance may be divided into three parts, namely:

(A) That part which is caused by the leakage flux which links with the portion of the armature inductors embedded in the iron core.

(B) That part which is caused by the leakage flux which links with the portion of the armature inductors which lies across the ventilating ducts. This is small.

(C) That part which is caused by the leakage flux which links with the end connections of the armature coils. Of these three parts (A) is the most important.

None of the three components into which the leakage flux has been assumed to be divided has any real existence, except that part which links with the end connections.

The leakage flux which causes the reactance in the portion of the inductors which is embedded in iron will be divided for convenience into slot leakage flux and tooth-tip leakage flux. The slot leakage includes that part of the leakage flux which passes straight across the slots and returns through the armature core. The tooth-tip leakage is that part of the leakage flux which passes from one armature tooth to the next through the air gap and returns through the armature teeth. A portion of this latter may get into the faces of the poles. In this case it usually is called zig-zag leakage. These two parts into which the leakage flux is

divided are indicated on Fig. 40. The return paths in the iron for only two of the leakage lines are shown.

The reluctance of that portion of the path for the leakage flux which is in the iron is very small compared with the reluctance of the portion of the path which lies in the air, and may be neglected in comparison with it in the calculation of the slot and tooth-tip leakage reactance.

Let Fig. 41 represent a slot containing two coil sides of a winding having a pitch of 180 degrees. With a full-pitch winding, the currents in the two coil sides will be in phase. Let each coil

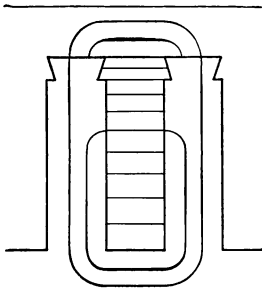

FIG. 40.

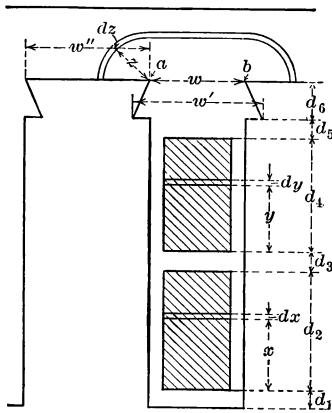

FIG. 41.

side be rectangular in cross-section and contain Z inductors in series. The coil sides are cross-hatched in the figure. The spaces between the coil sides and between the coil sides and the slot sides are occupied by insulation.

Let a be the length of the embedded inductors. This is equal to the length of the slot minus the total width of the ventilating ducts. The other dimensions are given on the figure. The dimensions, d_2 and d_4 , do not include the coil insulation.

It is evident that less flux will link with the upper coil side than with the lower. Consequently, the reactance of the upper coil side will be less than the reactance of the coil side in the bottom of the slot. Since all forms of windings having two coil sides in a slot have one side of each coil in the bottom of one slot and the

other side in the top of another slot, the slot reactance per coil will be the sum of the reactances of a coil side in the bottom of a slot and of a coil side in the top of a slot.

The linkages will always be greatest at the bottom of a slot. Therefore, if inductors having a large cross-section are used, more current will flow through the upper part of them than through the lower part. As a result, the apparent resistance of such inductors will be greater than the resistance calculated from their cross-section. The increase in the apparent resistance that may be obtained by the use of large inductors in deep slots is made use of in designing induction motors for large starting torque.

In what follows the current is assumed to be uniformly distributed over the cross-section of each inductor. The flux is assumed to pass directly across the slot and return in the iron of the armature below the slots.

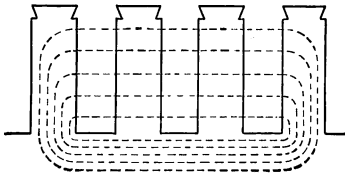

FIG. 42.

If there is more than one slot per pole per phase, the slot leakage flux in the teeth between

slots containing coil sides which are in the same phase will be made up of two components, one due to each slot. These components are equal and opposite and will neutralize. The slot leakage flux may, therefore, be assumed to take the path shown in Fig. 42. In this figure the three slots shown are in the same phase.

The phase reactance caused by slot leakage will be the same whether the slots per pole are considered individually or as a group. If a single slot is considered, the magnetomotive force causing slot leakage is that due to the inductors in that slot. This acts on a path in air which has an effective length equal to the width of the slot. If the phase belt is considered, both the magnetomotive force and the reluctance are increased in the same proportion. The flux is the same as with the single slot, but is linked with the inductors in three slots. This produces exactly the same result as when the slots are considered individually, since in this case the inductors in three slots are in series. The reactance will be worked out per slot. The phase reactance will then be found by multiplying the slot reactance by the number of slots in series per phase.

To be able to modify the formula to be derived for reactance so that it may easily be made to apply to those slots of a fractional-pitch winding which contain coil sides not in the same phase, the reactance of each slot will be split into two components: one due to the current carried by the inductors of the lower coil side, the other due to the current in the inductors of the upper coil side. In the case of a full-pitch winding, the drops caused by these two components will be in phase and will add directly. They will be out of phase in some or in all of the slots of a fractional-pitch winding by an amount equal to the phase difference between the currents carried by the two coil sides in any one slot. This phase difference is 60 degrees for a three-phase winding.

Reactance of the Lower Coil Side Due to the Current it Carries.
—For the purpose of calculating this reactance, the linkages of flux with inductors will be divided into three parts:

(a) That due to the flux which passes through the lower coil side.

(b) That due to the flux which passes across the slot above the lower coil side.

(c) That due to the tooth-tip leakage.

Part (a).—The magnetomotive force acting across the elementary area $a dx$ (Fig. 41) per c.g.s. unit of current is

$$4\pi \frac{Z}{d_2} x$$

Neglecting the reluctance of the iron, the reluctance of the path through which this magnetomotive force acts is

$$\frac{w}{a dx}$$

The flux, $d\phi$, across the elementary area $a dx$ is

$$d\phi = 4\pi \frac{Zx}{d_2} \frac{a dx}{w}$$

This flux links with $\frac{Zx}{d_2}$ inductors. Therefore, the linkages due to Part (a) are

$$\frac{4\pi a Z^2}{d_2^2 w} \int_0^{d_2} x^2 dx = \frac{4\pi a Z^2 d_2}{3w} = \text{Part (a)}.$$

Part (b).—The magnetomotive force per c.g.s. unit of current acting across the slot above the lower coil side is constant and is equal to $4\pi Z$. It acts on a path which is made up of two parts corresponding to the portions $d_3 + d_4 + d_5$ and d_6 of the slot. The reluctance of this path is

$$\frac{1}{\frac{a(d_3+d_4+d_5)}{w} + \frac{2ad_6}{w+w'}} = \frac{w(w+w')}{aw(d_3+d_4+d_5+2d_6) + aw'(d_3+d_4+d_5)}$$

The flux in $d_3 + d_4 + d_5 + d_6$ links with all of the inductors of the lower coil side. Therefore,

$$\frac{4\pi aZ^2 [w(d_3+d_4+d_5+2d_6) + w'(d_3+d_4+d_5)]}{w(w+w')} = \text{Part (b).}$$

Part (c).—The calculation of the tooth-tip leakage, at the best, can only be considered as an approximation, since the path of the tooth-tip leakage is uncertain and will change with the position of a slot with respect to a pole. Moreover, it is not certain whether it is best to consider it for each slot or for the group of slots in each phase belt.

In finding tooth-tip leakage it is customary to assume that the lines of induction from the teeth start as arcs of two groups of concentric circles drawn from the corners, a and b , of the tooth tips (see Fig. 41). In what follows this assumption will be made and the slots will be considered separately. The width of the flux belt will be taken equal to the width of a tooth. This is not strictly accurate, but as the reluctance of any elementary path (Fig. 41) increases rapidly as the distance from the corner of the tooth increases, it is close enough to consider the width of the flux belt as equal to the width of a tooth.

According to these assumptions, the tooth-tip leakage will be constant when the length of the air gap is equal to or greater than the width of a tooth at its tip, as in this case none of the tooth-tip leakage flux will enter the pole face. In reality, the tooth-tip leakage is not constant except for alternators with non-salient poles. For alternators with salient poles, it has different values according as a slot is opposite a pole or mid-way between two poles when the current is a maximum.

The tooth-tip reactance will be found in the following manner: Assume that the radial length of the air gap is greater than the

width of a tooth. Referring to Fig. 41, it will be seen that the reluctance of the path for the tooth-tip leakage is

$$\int_0^{w''} \frac{1}{\frac{a}{\pi z + w}} dz = \frac{\pi}{a \log_e \frac{\pi w'' + w}{w}}$$

The magnetomotive force acting on this path due to the lower coil side per c.g.s. unit of current is $4\pi Z$. The flux this produces links with all of the inductors in the coil side. Therefore,

$$4aZ^2 \log_e \frac{\pi w'' + w}{w} = \text{Part (c)}.$$

Reactance of the Lower Coil Side Due to the Current in the Upper Coil Side.—The linkages of flux for this will be divided into three parts:

(d) That due to the flux which passes across the upper coil side.

(e) That due to the flux which crosses the slot above the upper coil side.

(f) That due to tooth-tip leakage.

Part (d).—The magnetomotive force acting through any elementary area $a dy$ per c.g.s. unit of current in the upper coil side is

$$4\pi Z \frac{y}{d_4}$$

This divided by the reluctance, $\frac{w}{a dy}$, of the element dy and integrated between the limits of 0 and d_4 gives the total flux through the upper inductor. This flux is

$$4\pi Z \int_0^{d_4} \frac{y}{d_4} \frac{a dy}{w} = 2\pi Z a \frac{d_4}{w}$$

All of this links with the lower coil side. Therefore,

$$2\pi a Z^2 \frac{d_4}{w} = \text{Part (d)}.$$

Part (e).—The magnetomotive force per c.g.s. unit of current across the slot above the upper coil side is

$$4\pi Z$$

This acts in a path which is made up of two parts corresponding to the portions d_5 and d_6 of the slot. The reluctance of this path is

$$\frac{1}{\frac{ad_5}{w} + \frac{2ad_6}{w+w'}} = \frac{w(w+w')}{aw(d_5+2d_6) + aw'd_5}$$

The flux across this portion of the slot links with the lower coil side. Therefore,

$$4\pi aZ^2 \frac{w(d_5+2d_6) + w'd_5}{w(w+w')} = \text{Part (e)}.$$

Part (f).—The magnetomotive force producing tooth-tip leakage due to the upper inductor is

$$4\pi Z$$

The linkages with the lower inductor caused by this are (see Part (c))

$$4aZ^2 \log_e \frac{\pi w'' + w}{w} = \text{Part (f)}.$$

The total reactance in ohms of the lower coil side is equal to $2\pi f 10^{-9}$ times the total linkages of flux with the inductors in the lower coil side.

This is

$$\begin{aligned} x'_{slot} &= 2\pi f [(a+b+c) + (d+e+f)] 10^{-9} \\ &= 2\pi f (A+B) 10^{-9} \end{aligned} \quad (13)$$

For a full-pitch winding $(a+b+c) = A$ and $(d+e+f) = B$ are in phase and add directly. For a fractional-pitch winding they must be added vectorially.

$$A = \frac{4\pi aZ^2}{w} \left\{ \frac{d_2}{3} + \frac{w(d_3+d_4+d_5+2d_6) + w'(d_3+d_4+d_5)}{w+w'} + \frac{w}{\pi} \log_e \frac{\pi w'' + w}{w} \right\} \quad (14)$$

$$B = \frac{4\pi aZ^2}{w} \left\{ \frac{d_4}{2} + \frac{w(d_5+2d_6) + w'd_5}{w+w'} + \frac{w}{\pi} \log_e \frac{\pi w'' + w}{w} \right\} \quad (15)$$

If the notches in the slot for the wedge are neglected, the expressions for A and B may be much simplified. In this case $w' = w$. The depths d_2 and d_4 of the coil sides are equal and may be replaced by d . Let $t = d_3$ be the thickness of insulation

between the coil sides and let t' be the thickness of the insulation above the upper coil side including the thickness of the wedge. Then neglecting the notches

$$A = \frac{4\pi aZ^2}{w} \left\{ \frac{4d}{3} + (t + t') + 0.73 w \log_{10} \frac{\pi w'' + w}{w} \right\} \quad (16)$$

$$B = \frac{4\pi aZ^2}{w} \left\{ \frac{d}{2} + t' + 0.73 w \log_{10} \frac{\pi w'' + w}{w} \right\} \quad (17)$$

Reactance of the Upper Coil Side Due to the Current in its Inductors.—For purposes of calculation, the linkages of flux with inductors will be divided into three parts:

(g) That due to the flux which crosses the upper coil side.

(h) That due to the flux which crosses the slot above the upper coil side.

(i) That due to the tooth-tip leakage.

Part (g).—By referring to Part (a) for the lower coil side it will be seen that

$$\frac{4\pi aZ^2 d_4}{3w} = \text{Part (g)}.$$

Part (h).—From the similarity of this to Part (e) for the lower coil side it will be seen that

$$\frac{4\pi aZ^2 [w(d_5 + 2d_6) + w'd_5]}{w(w + w')} = \text{Part (h)}.$$

Part (i).—This is the same as Part (c) for the lower coil side.

$$4aZ^2 \log_e \frac{\pi w'' + w}{w} = \text{Part (i)}.$$

Reactance of the Upper Coil Side Due to the Current in the Lower Coil Side.—The linkages for this will be divided into three parts:

(j) That due to the flux which crosses the upper coil side.

(k) That due to the flux which passes across the slot above the upper coil side.

(l) That due to the tooth-tip leakage.

The sum of parts j , k and l must be equal to the sum of parts d , e and f , since the mutual inductance between two groups of wires is independent of the group to which it is referred.

Part (j).—The magnetomotive force per c.g.s. unit of current due to the lower coil side acting across the elementary area $a dy$ (Fig. 41) is

$$4\pi Z$$

The reluctance of the path corresponding to the element, dy , is

$$\frac{w}{a dy}$$

Therefore, the total linkages due to Part (j) are

$$\frac{4\pi a Z^2}{w d_4} \int_0^{d_4} y dy = \frac{2\pi a Z^2 d_4}{w} = \text{Part (j)}.$$

Part (k).—From similarity to Part (h) Part (k) is

$$\frac{4\pi a Z^2 [w(d_5 + 2d_6) + w'd_5]}{w(w + w')} = \text{Part (k)}.$$

Part (l).—This is the same as Part (c).

$$4aZ^2 \log_e \frac{\pi w'' + w}{w} = \text{Part (l)}.$$

The total slot reactance of the upper coil side in ohms is equal to

$$\begin{aligned} x''_{slot} &= 2\pi f [(g + h + i) + (j + k + l)] 10^{-9} \\ &= 2\pi f (C + D) 10^{-9} \end{aligned}$$

For a full-pitch winding $(g + h + i) = C$ and $(j + k + l) = D$ are in phase.

$$C = \frac{4\pi a Z^2}{w} \left\{ \frac{d_4}{3} + \frac{w(d_5 + 2d_6) + w'd_5}{w + w'} + \frac{w}{\pi} \log_e \frac{\pi w'' + w}{w} \right\} \quad (18)$$

$$D = \frac{4\pi a Z^2}{w} \left\{ \frac{d_4}{2} + \frac{w(d_5 + 2d_6) + w'd_5}{w + w'} + \frac{w}{\pi} \log_e \frac{\pi w'' + w}{w} \right\} \quad (19)$$

Part D must be equal to part B , since they are the linkages due to the mutual induction between the upper and lower coil sides.

Neglecting the notches in the slot for the wedge, replacing d_2 and d_4 by d and, as before, calling the depth $d_5 + d_6$ of the top of the upper coil side below the top of the slot t' , equations (18) and (19) may be simplified. Neglecting the notches

$$C = \frac{4\pi a Z^2}{w} \left\{ \frac{d}{3} + t' + 0.73w \log_{10} \frac{\pi w'' + w}{w} \right\} \quad (20)$$

$$D = \frac{4\pi a Z^2}{w} \left\{ \frac{d}{2} + t' + 0.73w \log_{10} \frac{\pi w'' + w}{w} \right\} \quad (21)$$

For a full-pitch winding, the total phase reactance is equal to the reactance of a coil side in the bottom of a slot plus the reactance of a coil side in the top of a slot multiplied by the number of slots in series per phase. Therefore, if s is the number of slots in series per phase, the total phase reactance in ohms of a full-pitch winding having slots with straight sides is

$$x'_a = 2\pi f s \{A + B + C + D\} 10^{-9} \quad (22)$$

Let $Z' = 2Z$ be the total number of inductors in series per slot. Then, from equation (22), the phase reactance in ohms of a full-pitch winding due to slot and tooth-tip leakage is

$$x'_a = \frac{2\pi^2 f a s Z'^2}{w} \left\{ 2.7d + 4t' + t + 2.9w \log_{10} \frac{\pi w'' + w}{w} \right\} 10^{-9} \quad (23)$$

This does not include the reactance of the end connections. This latter must be added.

Reactance of End Connections.—The leakage flux which links with the end connections has its path chiefly in air. Although the end connections lie near considerable masses of iron, they are always kept as far as possible from such parts and usually only a small percentage of leakage flux of the end connections enters those parts. Due to the shape and the proximity of the end connections to one another, it is impossible to make any accurate calculation of the end-turn leakage. For this reason, it is best when possible to calculate the reactance of end connections from experimental data. An approximate value of the reactance of the end connections may be found by multiplying their length by $2\pi f N^2 \varphi_e 10^{-8}$, where φ_e is the leakage flux per ampere per unit length of end connection. The end-connection leakage flux, φ_e , will usually lie between 0.5 and 1.0 line per ampere per centimeter length of conductor.

When the end-connection leakage reactance is calculated from the dimensions of the end connections, it is customary to assume this reactance to be equal to the reactance of a circular

coil having the same number of turns and the same mean length as the end connections.

Referring to Fig. 43, the left-hand figure represents an armature coil. The dotted portions or the portions outside the dot-and-dash lines are the end connections. These butted together give the middle figure. The right-hand figure is the circular coil which has a mean length equal to the mean length of the end connections. The mean radius of this circular coil is $\frac{l}{2\pi}$, where l is the mean length of the end connections (see Fig. 43).

For purposes of calculation, the lines of induction for the circular coil will be assumed as circles having their planes perpendicular to the plane of the coil and having their centers in a

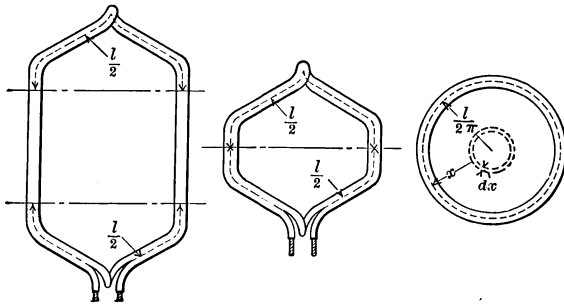

FIG. 43.

line which passes through the center of the cross-section of the coil. This line is dotted in the figure.

Consider any element in the plane of the coil at a distance x from the dotted line, Fig. 43. The length of a line of induction for this element is $2\pi x$. All elements of width, dx , at this distance will form a circular ring shown dotted in the figure. The radius of this ring is $\frac{l}{2\pi} - x$. The radius of this ring will increase as the elements dx move out of the plane of the coil. The radius in any position will be $\frac{l}{2\pi} - x \cos \theta$, where θ is the angle made by the line x with the plane of the coil.

The mean cross-section of the ring between $\theta = 0$ and $\theta = 2\pi$ is

$$\int_0^{2\pi} \frac{2\pi}{2\pi} \left\{ \frac{l}{2\pi} - x \cos \theta \right\} dx d\theta = l dx$$

The reluctance of the leakage path is

$$\int_{x=\frac{d'}{2}}^{x=\frac{l}{2\pi}} \frac{2\pi x}{l dx} = \frac{2\pi}{l} \frac{1}{\log_e \frac{l}{\pi d'}} = \frac{2\pi}{2.3l} \frac{1}{\left(\log_{10} \frac{l}{d'} - 0.5 \right)}$$

where d' is the longest diagonal of the cross-section of the coil. If the coil contains Z turns, its reactance is

$$2\pi f(4\pi Z^2) \frac{2.3l}{2\pi} \left(\log_{10} \frac{l}{d'} - 0.5 \right)$$

$$x_e = 2\pi f(4.6 l Z^2) \left(\log_{10} \frac{l}{d'} - 0.5 \right) 10^{-9} \text{ ohms} \quad (24)$$

This multiplied by the number of coils in series per phase will give the phase, end-connection reactance.

Total Leakage Reactance.—The total phase reactance in ohms of a full-pitch winding having s straight-sided slots with two coil sides per slot is, from equations (23) and (24),

$$x_a = 2\pi^2 f s Z'^2 \left\{ \frac{a}{w} \left[2.7d + 4l' + t + 2.9w \log_{10} \frac{\pi w'' + w}{w} \right] + 0.37l \left(\log_{10} \frac{l}{d'} - 0.5 \right) \right\} 10^{-9} \quad (25)$$

The omission of the phase *belt leakage* seems justified as it is of minor importance with fractional-pitch windings and its value is quite uncertain with any type of winding.

Equivalent Leakage Reactance.—For a given size and shape of slot and fixed coil pitch, the leakage flux per ampere per inductor per unit length of slot is nearly constant. This statement is also approximately correct when applied to the end connections. When dealing with a given type of armature stamping it is, therefore, permissible and often convenient to make use of an equivalent leakage flux which may be defined in the following manner: The equivalent leakage flux is that flux per ampere per unit length of embedded inductor which, if linked with all of the inductors in a slot, would produce a

reactance which would be equal to the actual slot and tooth-tip reactance plus one-half of the reactance of the end connections for the inductors in a pair of slots. The value of this equivalent leakage flux varies from 2.5 to 6 lines per ampere per centimeter length of embedded inductor. It depends mainly upon the shape and size of the slots.

If φ_e is the equivalent leakage flux per ampere per unit length of embedded inductor, the equivalent leakage flux per slot is

$$l\varphi_e Z$$

where l and Z are, respectively, the length of the embedded inductors and the number of inductors in series per slot. The slot linkages due to this flux are

$$l\varphi_e Z^2$$

and if there are s slots in series per phase, the phase reactance in ohms is

$$x_a = 2\pi f l \varphi_e Z^2 s 10^{-8} \quad (26)$$

Effective Resistance.—The apparent or effective resistance of a circuit to an alternating current is greater than its resistance to a steady current and it may be several times greater. When an electric circuit carries an alternating current, hysteresis losses are produced in any adjacent magnetic material and eddy-current losses in neighboring conducting media and in the conductor itself.

The losses increase the total power supplied to the circuit and produce an increase in the energy component of the voltage drop through the circuit. This increase in the voltage drop is equivalent to an apparent increase in the resistance of the circuit. The tendency of the flux within the conductors to distort the current distribution and make the current density through the cross-section of the conductors non-uniform may still further increase the apparent resistance when the conductors are large. This effect has already been mentioned under leakage reactance. The apparent resistance is called the effective resistance and is equal to the total loss of power in the circuit caused by the current divided by the square of the current. If the apparent increase in resistance is due to iron losses, the effective resistance will not be constant, since the iron losses are not proportional to

the square of the flux causing them. Moreover, the flux and the current which produces it will not be proportional in most cases.

In the case of an alternator, the leakage flux distorts the field in the armature teeth and causes local losses in them and also in the armature inductors themselves. These losses produce an apparent increase in the armature resistance which in many cases may be as much as 50 per cent. The difference between the ohmic and effective resistance depends upon many factors such as the shape and size of the slots, the cross-section of the armature inductors and the frequency. The effective resistance should always be used in calculating the regulation of an alternator and also in calculating its efficiency, unless the effect of the local losses due to the load are taken account of in some other way.

Factors which Influence the Effect and Magnitude of Armature Reaction, Armature Leakage Reactance and Armature Effective Resistance.—*Armature Reaction.*—Armature reaction expressed in ampere-turns depends only upon the number of inductors on the armature, their distribution and the current they carry, but the effect of a given number of ampere-turns of armature reaction depends upon the power factor of the load, the ratio of pole arc to pole pitch and the degree of saturation of the magnetic circuit. The effect of power factor on armature reaction has already been considered. With a pole arc of 180 degrees, the full belt of armature magnetomotive force due to armature reaction is effective in modifying the flux, but with pole arcs of less than 180 degrees, only that portion of the ampere-turns which is directly over the pole face is effective. This is considered in the discussion of the direct component of the armature reaction used in the double-reaction method for determining regulation.

To make the effect of armature reaction small, the ratio of effective armature ampere-turns to field ampere-turns should be made as small as possible. This may be accomplished by using a high degree of saturation in the magnetic circuit or by using a large air gap. The higher the degree of saturation, the less will be the effect of a given number of ampere-turns of armature reaction; but high saturation in the field circuit is undesirable as it greatly increases the field-pole leakage. Increasing the

length of the air gap will have a similar effect so far as armature reaction is concerned, but it will not increase the field leakage to so great an extent as increasing the degree of saturation of the field circuit.

Distributing or reducing the pitch of the armature winding diminishes the armature reaction to some extent, but it also decreases the generated voltage in the same proportion. To restore the voltage, either the air-gap flux or the number of armature inductors must be increased. Increasing the number of armature inductors will affect both the reaction and the voltage alike and nothing will be gained. If the voltage is restored by increasing the flux, the effect of armature reaction will be diminished but the pole leakage will be somewhat increased.

Armature Leakage Reactance.—The armature leakage reactance depends upon the size and shape of the slots, the number of inductors in series in the slots and the number of slots in series per phase. The shape of the slots has a large influence on slot reactance. The leakage flux which causes the reactance is proportional to the magnetomotive force producing it and is inversely proportional to the reluctance of the magnetic circuit through which the magnetomotive force acts. The total magnetomotive force acting across any slot is nearly proportional to the number of inductors in series per slot. The reluctance of the path for the flux caused by this magnetomotive force, however, will be far from independent of the shape of the slot. It will be greatest for a wide, shallow slot and least for a narrow, deep slot. Therefore, other things being equal, the reactance caused by narrow slots will be greater than that caused by wide slots. Shallow, wide slots are objectionable on account of the mechanical difficulty of holding the armature inductors in place and also on account of the variations they produce in the air-gap flux. These variations will tend to introduce harmonics into the electromotive-force wave and will also increase the pole-face losses. Increasing the flux density of the armature teeth will somewhat decrease the leakage reactance, but the influence of this will not be great with open slots.

The tooth-tip leakage of an alternator with salient poles will be influenced by the power factor of the load, since the position, with respect to a pole, of any slot when it carries its maximum

current depends upon the power factor. Considering a concentrated full-pitch winding, the slots will be opposite the center of the poles at maximum current when the power factor is unity. They will be midway between poles at maximum current when the power factor is zero. It will be seen from Fig. 44 why the reluctance of the leakage path for the tooth-tip leakage is somewhat greater when the slot is midway between the poles. Therefore, the reactance drop will be least for zero power factor. The relative size of the slot as compared with the pole is much exaggerated in Fig. 44. The change in the total slot reactance caused by ordinary changes in power factor is small, especially in the case of alternators with distributed windings and with air gaps which are larger than the slot openings.

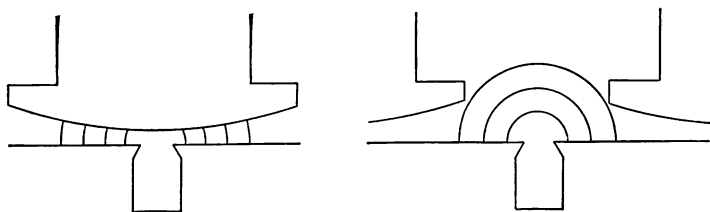

FIG. 44.

The thing which has by far the most influence upon reactance is the distribution of the armature winding. Reactance varies as the square of the number of inductors per slot. Therefore, if the armature inductors of each phase of an alternator are distributed among n slots per pole instead of being concentrated in a single pair, the slot reactance, other conditions remaining constant, will be reduced to

$$n \frac{1}{n^2} = \frac{1}{n}$$

A distributed winding will require smaller slots but more of them than a concentrated one. This will tend to decrease the magnitude of the local variation produced in the pole-face flux by the slots, but the frequency of this variation will be increased. The net effect will be a slight reduction in the pole-face losses.

The pitch of a winding will also influence the leakage reactance of a polyphase alternator. When a fractional-pitch winding is used on a polyphase alternator with a distributed winding, there

will be an overlapping of the phases and as a result some slots will contain coil sides which are not in the same phase. The resultant leakage flux of these slots is produced by two currents which, in the case of a three-phase alternator, differ in phase by 60 degrees. This resultant flux will obviously be less than it would be if the coil sides contained in any one slot carried currents which were in phase. The decrease in the leakage flux of some of the slots when a fractional-pitch winding is used on a poly-phase generator will make the average slot reactance of such a generator somewhat less than the slot reactance of a generator with a corresponding full-pitch winding. Decreasing the pitch decreases the reactance of the end connections.

Armature Effective Resistance.—The effective resistance of an armature winding is made up of two parts, viz.: the ohmic resistance and the part which is due to local eddy-current or hysteresis losses in the teeth and other metal adjacent to the armature inductors. If inductors with large cross-section are used, the leakage flux will also produce eddy-current losses in them. The ohmic resistance will depend upon the size, length and cross-section of the inductors of the armature winding. Since a considerable portion of the wire used on an armature is for end connections, the use of a fractional-pitch winding will somewhat decrease the armature resistance. Other conditions beside the reduction of resistance determine whether a fractional-pitch winding is used. The part of the effective resistance which is caused by the local losses produced by the armature current depends upon the size of the armature inductors and the size and the shape of the slots. In general, anything that will increase the leakage reactance of a winding will increase the tooth-tip core loss and hence the effective resistance.

The Conditions for Best Regulation.—

$$E_a = 4.44Nf\phi_m 10^{-8}$$

$$x_a = kN^2fs$$

and

$$A \propto N$$

The letters have the same significance as when used before. If the voltage, flux and frequency are fixed, N cannot be reduced without increasing the speed, but the speed cannot be changed

as it is fixed by the number of poles and the frequency. N can be reduced by increasing the flux density in the air gap. This will necessitate an increase in the field ampere-turns and will increase the field leakage. Armature reaction is diminished by using a distributed winding, but the decrease which can be obtained in this way in the case of polyphase alternators is small. About 5 per cent. is a maximum in the case of a three-phase generator. To reduce the effect of armature reaction, increase the flux density in the air gap and reduce the armature turns proportionally. The length of the air gap will have an important influence on the regulation of an alternator. Increasing its length will decrease the effect of armature reaction and improve the regulation.

For best regulation use a high air-gap density with moderate flux density in the field, and make the ratio of the field magnetomotive force to the armature magnetomotive force large. A short air gap is undesirable as it will make the regulation poor and will cause the wave form to become distorted under load by exaggerating the field distortion produced by armature reaction. Very narrow deep slots are undesirable from the standpoint of regulation.

The ranges of densities in lines per square inch ordinarily used in the design of alternators are:

Air gap.....	40,000 to 60,000
Armature teeth.....	90,000 to 120,000
Armature core.....	50,000 to 100,000

Single-phase Rating.—The ratio of the single- and three-phase ratings of a three-phase generator for fixed inductor copper loss is 16 per cent. greater for Y connection than for Δ connection. Let I , V , and $\cos \theta$ be, respectively, the phase current, the phase voltage and the load power factor. Then for

$$Y \text{ connection } \frac{\textit{Single-phase output}}{\textit{Three-phase output}} = \frac{(\sqrt{3} V) I \cos \theta}{3 V I \cos \theta} = 0.58$$

$$\text{for } \Delta \text{ connection } \frac{\textit{Single-phase output}}{\textit{Three-phase output}} = \frac{V (3/2 I) \cos \theta}{3 V I \cos \theta} = 0.50$$

CHAPTER V

VECTOR DIAGRAM OF AN ALTERNATOR WITH NON-SALIENT POLES; VECTOR DIAGRAM APPLIED AS AN APPROXIMATION TO AN ALTERNATOR WITH SALIENT POLES; CALCULATION OF THE REGULATION OF AN ALTERNATOR FROM ITS VECTOR DIAGRAM; SYNCHRONOUS-IMPEDANCE AND MAGNETOMOTIVE-FORCE METHODS FOR DETERMINING REGULATION; DATA NECESSARY FOR THE APPLICATION OF THE SYNCHRONOUS-IMPEDANCE AND THE MAGNETOMOTIVE-FORCE METHODS; EXAMPLES OF THE CALCULATION OF REGULATION BY THE SYNCHRONOUS-IMPEDANCE AND MAGNETOMOTIVE-FORCE METHODS; POTIER METHOD; AMERICAN INSTITUTE METHOD; EXAMPLE OF THE CALCULATION OF REGULATION BY THE AMERICAN INSTITUTE METHOD; VALUE OF A' OF THE MAGNETOMOTIVE-FORCE METHOD FOR NORMAL SATURATION; EXAMPLE OF THE CALCULATION OF REGULATION BY THE MAGNETOMOTIVE-FORCE METHOD USING THE VALUE OF A' OBTAINED FROM A ZERC-POWER-FACTOR TEST; BLONDEL TWO-REACTION METHOD FOR DETERMINING REGULATION OF AN ALTERNATOR; EXAMPLE OF THE CALCULATION OF REGULATION BY THE TWO-REACTION METHOD

Vector Diagram of an Alternator with Non-salient Poles.— Consider a polyphase alternator having a distributed armature winding and non-salient poles. Assume that the field winding is distributed in such a way as to produce a sine distribution of magnetomotive force in the air gap. Then, if the load is balanced and the armature current is sinusoidal, the armature reaction and the impressed field may be treated as vectors and combined as such provided proper consideration is given to their phase relation.

A field structure with non-salient poles and a properly distributed winding can be made to give approximately a sinusoidal flux distribution. A spiral winding such as is shown in the

upper portion of Fig. 45 can be used for this purpose. Any form of distributed winding with the inductors properly placed would answer equally well. The distribution of magnetomotive force produced by this winding is shown in the lower part of this figure. The flux distribution corresponding to this would be similar in form but with the sharp corners rounded off giving a comparatively smooth curve.

Fig. 46 is the vector diagram of an alternator with non-salient poles. All currents and all voltages on the vector dia-

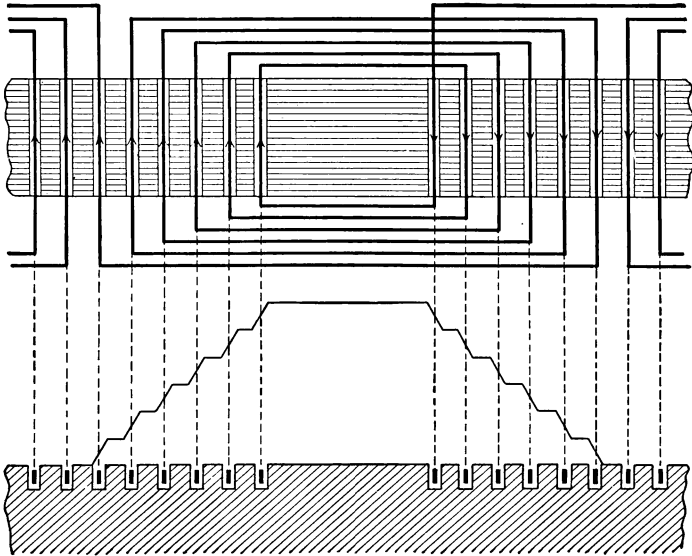

FIG. 45.

grams of alternators must be per phase. The magnetomotive force of armature reaction, on the other hand, must always be for all phases. Since the reactions of all phases combine to modify the resultant field, they are directly additive and affect the voltage of all phases alike. All magnetomotive forces will be expressed in ampere-turns per pole.

Referring to Fig. 46, V is the terminal voltage per phase, *i.e.*, the voltage between terminals if the alternator is Δ -connected, and that voltage divided by the square root of 3 if the

alternator is connected in Y . I_a is the phase current. This is the same as the line current or the current per terminal for Y connection, or the line current divided by the square root of 3 for Δ connection.

The angle of lag, θ , is the angle between the phase current and the phase voltage. $I_a r_e$ and $I_a x_a$ are the effective resistance and the leakage reactance drops respectively. Adding these drops vectorially to V gives E_a , which is the voltage rise generated by the air-gap flux, ϕ_R . This is the flux which is produced by the combined action of the impressed field and the armature reaction, and will be called the resultant field. It must lead the voltage

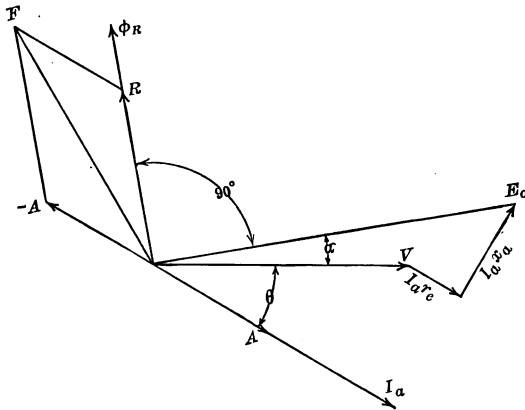

FIG. 46.

rise, E_a , in the armature by 90 degrees in time. Let R be the resultant magnetomotive force required to produce the flux ϕ_R . All vectors, so far mentioned, are time vectors. R is also a space vector when considered with respect to the field structure. Since the armature reaction is constant and fixed in direction with respect to the field it is, in this sense, a space vector. It is also a time vector when considered with respect to the armature coils. Both R and the armature reaction, A , must be considered in the same sense, but it is immaterial whether both be considered as time vectors or as space vectors. The phase relation between them is, of course, the same in either case.

If it were not for armature reaction, R would be the magnetomotive force of the impressed field. The armature reaction, as has already been explained, is in phase with the current and is shown by A on the diagram. On account of the armature reaction, the impressed field must have a component, $-A$, to balance it. Adding R and $-A$ vectorially gives the field magnetomotive force, F , which is required to produce the terminal voltage V . This assumes that the coefficient of field leakage is unaffected by a change in load, an assumption which is nearly enough correct in most cases. It also assumes that the reluctances of the magnetic circuits for F , A and R are equal. This latter assumption is very nearly correct in this case, since the alternator was assumed to have non-salient poles.

Vector Diagram Applied as an Approximation to an Alternator with Salient Poles.—The vector diagram given in Fig. 46 and the method of calculating the regulation of an alternator from this diagram are correct only when applied to alternators with non-salient poles. For reasons which were given under "Armature Reaction," page 64, it must be considered as an approximation when applied to other alternators; but, in spite of this, the regulation of alternators with salient poles calculated from the vector diagram shown in Fig. 46 is often quite satisfactory.

Calculation of the Regulation of an Alternator from its Vector Diagram.—The following example will serve to illustrate the method of calculating the regulation of an alternator from its vector diagram. For the want of a better name, this method of calculating the regulation will be referred to as the "general method."

A three-phase, Y -connected, 5000-kv-a., 6600-volt alternator with salient poles which is intended for use with a water turbine has 30 poles, each with 67.5 turns, and operates at 240 rev. per min. The armature has 360 slots and a full-pitch winding with two inductors in series per slot. The length of the embedded inductor is 21.5 in. At 25°C. the resistance of the armature between any two terminals is 0.0836 ohm. Assume an equivalent leakage flux of 6.5 lines per ampere per inch of embedded inductor and a ratio of 1.65 between the effective and ohmic armature resistances.

The full-load phase current and phase voltage are, respectively,

$\frac{5,000,000}{6600\sqrt{3}} = 437$ amp. and $\frac{6600}{\sqrt{3}} = 3810$ volts. The frequency is $\frac{240 \times 15}{60} = 60$ cycles. There are 12 slots per pole and 4 per

pole per phase. The phase spread is, therefore, $\frac{4}{12}180 = 60$ degrees or one-third of the pole pitch. Since the alternator is Y-connected, its effective resistance is $\frac{0.0836}{2}1.65 = 0.0690$ ohm. per phase.

Substituting the proper values in equations (10) and (26), pages 59 and 78 respectively, gives, respectively, A , the armature reaction per pole, and x_a , the armature leakage reactance per phase.

$A = 0.707NI_a = 0.707\left(\frac{12 \times 2}{2}\right)437 = 3708$ ampere-turns per pole.

$x_a = 2\pi f l \phi_e Z^2 s 10^{-8} = 2\pi 60 \times 21.5 \times 6.5 \times 2^2 \times \frac{360}{3} 10^{-8} = 0.253$ ohm.

The factor by which the armature reaction should be multiplied to allow for the spread of the winding is found to be 0.958 from Table I, page 41. The corrected armature reaction is, therefore, $3708 \times 0.958 = 3550$ ampere-turns per pole.

The following relations are derived from the vector diagram given in Fig. 46. All vectors are expressed as complex quantities and are referred to V as an axis.

$$\begin{aligned} I_a &= I_a(\cos \theta - j \sin \theta) \\ E_a &= V + I_a(\cos \theta - j \sin \theta)(r_e + jx_a) \end{aligned}$$

Consider a full kilovolt-ampere load of 0.8 power factor lagging. Then

$$\begin{aligned} E_a &= 3810 + 437(0.8 - j0.6)(0.0690 + j0.253) \\ &= 3900 + j70.3 \\ &= \sqrt{(3900)^2 + (70.3)^2} = 3901 \text{ volts.} \end{aligned}$$

The flux corresponding to this voltage is ϕ_R on the vector diagram. The maximum value of this flux may be found by substituting the voltage 3901 in equation (2), page 21. This would be the impressed field if there were no armature reaction. If the ampere-turns required per pole to produce the flux ϕ_R are

calculated from the dimensions of the magnetic circuit and are added vectorially to the armature reaction expressed in ampere-turns per pole, the sum will be the impressed field—*i.e.*, the ampere-turns required per pole on the field. This divided by the turns per pole will give the field current which would be required if there were no field-pole leakage. To get the true field current, this current must be multiplied by the coefficient of field leakage which usually will be between 1.15 and 1.25. The no-load voltage, E'_a , is the voltage which would be generated by the impressed field. To find this voltage, the flux corresponding to the impressed field would first have to be found.

When determining the regulation of an alternator by the method just given, it is best to calculate an open-circuit characteristic or no-load saturation curve from the dimensions of the alternator. The open-circuit characteristic or no-load saturation curve is a curve plotted with open-circuit voltages as ordinates and with either field ampere-turns, preferably per pole, or field current as abscissæ. If the alternator is already built, it is better to obtain this curve by measuring the open-circuit voltages when the alternator is operated at rated frequency with different field excitations. The open-circuit characteristic of the alternator used in the calculations is plotted in Fig. 51, page 97, with the field currents as abscissæ and with the terminal voltages as ordinates. R , on the vector diagram, is the number of turns per pole multiplied by the field current found from the open-circuit characteristic corresponding to a voltage $E_a\sqrt{3} = 3901\sqrt{3} = 6757$. It is necessary to multiply E_a by the square root of 3 before using it on the characteristic, since the open-circuit characteristic is plotted with terminal voltages for ordinates. The terminal voltage of a Y -connected alternator is $\sqrt{3}$ times its phase voltage. R is equal to $67.5 \times 161 = 10,870$ ampere-turns per pole.

From the vector diagram,

$$\begin{aligned} F &= R - A \text{ vectorially} \\ &= R(-\sin \alpha + j \cos \alpha) - A(\cos \theta - j \sin \theta), \end{aligned}$$

and

$$\begin{aligned} \sin \alpha &= \frac{\text{imaginary part of } E_a}{E_a} \\ \cos \alpha &= \frac{\text{real part of } E_a}{E_a} \end{aligned}$$

Substituting numerical values in these equations gives

$$\sin \alpha = \frac{70.3}{3901} = 0.0180$$

$$\cos \alpha = \frac{3900}{3901} = 1.000$$

$$\begin{aligned} F &= 10,870(-0.0180 + j1.00) - 3550(0.8 - j0.6) \\ &= -3033 + j13,000 \\ &= 13,360 \text{ ampere-turns per pole.} \end{aligned}$$

The field current corresponding to this is

$$\frac{13,360}{67.5} = 198.0 \text{ amp.}$$

On open circuit this field current will give a terminal voltage of 7350.

The regulation is, therefore,

$$\frac{7350 - 6600}{6600} = 11.4 \text{ per cent.}$$

The Synchronous-impedance and the Magnetomotive-force Methods for Determining Regulation.—It is seldom that the regulation of a large alternator can be determined by actual measurement, on account of the expense of making such a test, as well as on account of the impossibility of obtaining sufficient power in ordinary shops to operate large generators under full-load conditions. It would also be difficult to obtain an artificial load of sufficient magnitude.

To avoid the necessity for loading an alternator in order to determine its regulation, a number of approximate methods have been developed which require only such measurements as can be made with the alternator operating on open-circuit and on short-circuit. Such tests require comparatively little power.

Two of the best-known approximate methods for determining the regulation of an alternator are the "synchronous-impedance" method and the "magnetomotive-force" method. These are often called the "pessimistic" and the "optimistic" methods, respectively, since, when the data required for them are obtained from a short-circuit test, the regulation calculated by the former is always worse and by the latter usually better than the true regulation found from a load test. The magnetomotive-force method gives the better results under these conditions.

Synchronous-impedance Method.—This assumes the reluctance of the magnetic circuit is constant. If the effects of the magnetomotive forces of the impressed field and of the armature reaction are assumed to be the same as if each acted alone, they may be replaced by the voltages they would produce, if acting separately. If this substitution is made, there will be nothing left on the vector diagram but electromotive forces. The magnetomotive forces of the impressed field and the armature reaction are replaced by equivalent electromotive forces in Fig. 47.

The two magnetomotive forces which have been replaced are shown dotted in order to make the diagram clearer. The voltage

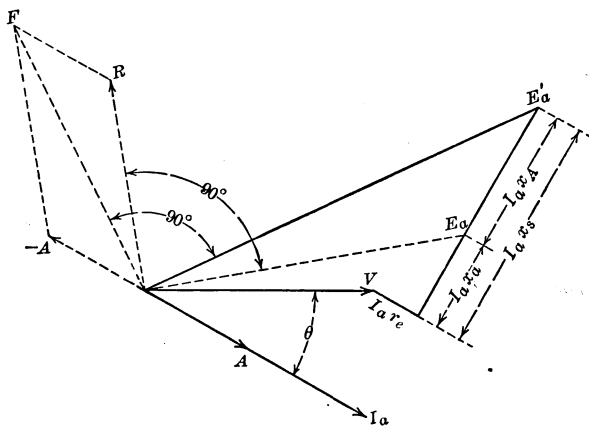

FIG. 47.

drop $I_a x_A$ which replaces $-A$ will be 90 degrees behind $-A$ or 90 degrees ahead of the current. It will, therefore, be in phase with the voltage drop $I_a x_a$ which is the leakage reactance drop in the armature. The voltage drop $I_a x_A$ may be considered as due to a fictitious reactance, x_A , and may be combined with $I_a x_a$ to form a reactance drop $I_a x_s$. The reactance x_s is known as the synchronous reactance. It includes both the leakage reactance and a fictitious reactance, x_A , which replaces the effect of armature reaction. The fictitious reactance, x_A , is not equivalent to a reactance except under steady conditions of operation (Chapter VIII, page 133).

The synchronous reactance of an alternator is not constant. It varies with the degree of saturation of the magnetic circuit and also, except in the case of generators with non-salient poles, with the power factor of the load. The part x_a of the synchronous reactance is nearly constant for ordinary alternators with open slots. The part x_A , however, is far from constant and varies with the saturation since it is proportional to the flux corresponding to armature reaction. The same magnetomotive force of armature reaction will produce different amounts of flux at different saturations. If an alternator has salient poles, a definite amount of armature reaction will produce different results at different power factors. Its maximum effect will be at zero power factor when the axis of the magnetic circuit for the armature reaction coincides with the axis of the field poles. Its minimum effect will be at unity power factor when its axis lies midway between two poles.

To give correct results, the synchronous impedance should be obtained under the conditions of saturation and power factor at which it is to be used. This is impossible and, as a consequence, the synchronous-impedance method, at the best, can give only approximate results.

Referring to Fig. 47 it will be seen that the vector sum of V , $I_a r_e$ and $I_a x_s$ is the open-circuit voltage E'_a . Use the terminal voltage V as an axis of reference. Then

$$E'_a = V + I_a(\cos \theta - j \sin \theta) (r_e + jx_s) \quad (27)$$

and the regulation is

$$\frac{E'_a - V}{V} 100 \text{ per cent.}$$

When the alternator is short-circuited, its terminal voltage becomes zero, and the vector diagram given in Fig. 47 collapses into that given in Fig. 48.

The synchronous impedance, z_s , is the ratio of the voltage E'_a to the short-circuit phase current, where E'_a is the open-circuit voltage at normal frequency corresponding to the field excitation required to produce the current I_a on short-circuit.

$$z_s = \frac{E'_a}{I_a}$$

and

$$x_s = \sqrt{z_s^2 - r_e^2}$$

The effective resistance, r_e , is seldom more than one-tenth as large as the synchronous reactance and usually may be neglected when finding x_s . $x_s = z_s$ approximately.

The value of x_s found in this manner is for low power factor and low saturation. Normal power factor and normal saturation can never be reached in an alternator operating short-circuited. Consequently, the synchronous reactance will be too large and the calculated regulation will be worse than the true regulation.

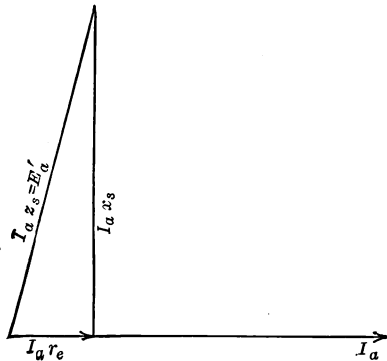

FIG. 48.

The best value of x_s to use when applying the synchronous-impedance method is the one corresponding to the largest field excitation that can safely be used when the generator is short-circuited.

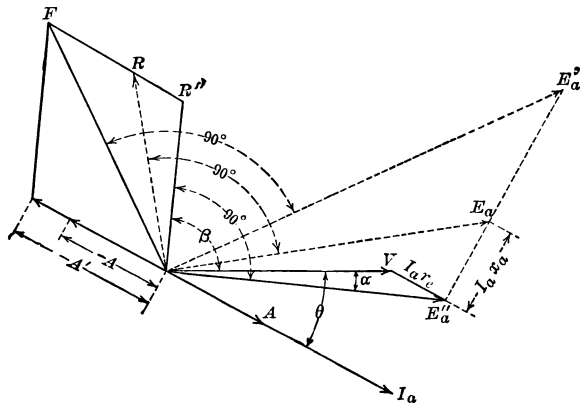

FIG. 49.

The Magnetomotive-force Method.—This method, like the synchronous-impedance method, assumes the reluctance of the magnetic circuit is constant. In the synchronous-impedance method for finding the regulation of an alternator, the armature

reaction is replaced by a fictitious reactance which is combined with the armature leakage reactance. In the magnetomotive-force method, the leakage reactance voltage is replaced by the magnetomotive force which would be required to produce an equal voltage. This magnetomotive force will be 90 degrees behind the reactance drop and consequently in phase with the armature reaction with which it is combined, giving a fictitious armature reaction which will be called A' . On the vector diagram for this method which is given in Fig. 49, $-A'$ is used instead of A' . The vectors which are shown as full lines on Fig. 49 are the only ones belonging to the magnetomotive-force method. The others are dotted and are added merely to make the diagram clearer.

The vector diagram for the magnetomotive-force method is the same as the true vector diagram of an alternator which has no leakage reactance.

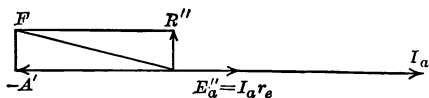

FIG. 50.

E''_a is equal to the vector sum of the terminal voltage and the resistance drop. To produce this voltage a magnetomotive force R'' is required which is in quadrature with E''_a and is equal to the field required to produce this voltage when the generator is on open-circuit. The fictitious reaction, $-A'$, is found from measurements made with the alternator short-circuited.

When the alternator is short-circuited, the terminal voltage becomes zero and the vector diagram reduces to the form shown in Fig. 50.

$E''_a = I_a r_e$ is small. Consequently, R'' , the magnetomotive force corresponding to E''_a , is also small and may be neglected in comparison with $-A'$.

$$\begin{aligned} A' &= \sqrt{(F)^2 - (R'')^2} \\ &= F \text{ approximately.} \end{aligned}$$

The value of A' for the vector diagram given in Fig. 49 is, therefore, equal to the impressed field required to produce the armature current, I_a , when the generator is short-circuited. The

impressed field, F , under load conditions is the vector sum of R'' and $-A'$. If E'_a is the open-circuit voltage corresponding to the excitation F , the regulation is

$$\frac{E'_a - V}{V} \cdot 100 \text{ per cent.}$$

The value of $-A'$ used in the calculation of the regulation by the magnetomotive-force method is found with the generator operating short-circuited and is, consequently, for low saturation as well as for low power factor. On low saturation, a smaller magnetomotive force is required to produce a given voltage than at normal operating saturation. Consequently, that part of $-A'$ which replaces $I_a x_a$ will be too small for the condition of normal saturation. On account of the low power factor on short-circuit, the effect of armature reaction in the case of alternators with salient poles will be a maximum and will be considerably higher than it would be if the power factor were more nearly that met under ordinary operating conditions. Due to this latter cause, the value of $-A'$ will be larger than it should be. In the case of alternators with salient poles both these effects will be present and will tend to neutralize each other. In spite of this, however, the regulation of generators with salient poles found by the magnetomotive-force method is usually lower than the regulation obtained from measurements made under actual load conditions. The effects produced, in the synchronous-impedance method, by low saturation and low power factor on the synchronous reactance both tend to make the value of the synchronous reactance too large. The synchronous-impedance method will, therefore, always give a poorer regulation than the actual.

Data Necessary for the Application of the Synchronous-impedance and the Magnetomotive-force Methods.—In order to apply either the synchronous-impedance or the magnetomotive-force method, the following data are necessary:

- (a) The effective armature resistance per phase.
- (b) The open-circuit characteristic.
- (c) The short-circuit characteristic.

No other information is required except the name-plate rating.
Effective Resistance.—The effective resistance of an alternator

may be found by multiplying its ohmic resistance by a suitable constant which will depend upon the type and the design of the alternator, or it may be obtained by direct measurement by one of the approximate methods for measuring the effective resistance which will be given later. The ohmic armature resistance per phase of a three-phase alternator is not the same as the ohmic resistance between its terminals. For a Y -connected alternator it is $\frac{1}{2}$, and for a Δ -connected alternator it is $\frac{3}{2}$, of the resistance between the terminals. The phase resistance and the resistance between the terminals are the same for either a single-phase or a two-phase alternator.

Open-circuit Characteristic.—The open-circuit characteristic is a curve plotted for rated frequency with open-circuit voltages as ordinates and the corresponding field excitations as abscissæ. Either terminal voltage or phase voltage may be plotted. The excitation may be expressed in amperes or in ampere-turns. Since with any fixed excitation the open-circuit voltage of a generator varies directly as the speed, it is possible to apply a correction to the measured voltages in case the frequency cannot be maintained exactly constant. The open-circuit characteristic should always extend from zero excitation up to the maximum excitation for which the alternator is designed.

Short-circuit Characteristic.—The short-circuit characteristic shows the relation between the short-circuit armature current and the field excitation. This curve should always extend to at least one and one-half times the full-load current and as much further as is possible without overheating the alternator.

The magnitude of the steady short-circuit current of an alternator at normal excitation depends upon its design and its size. This current will lie between one and one-half and five times the rated full-load current. It is limited by the synchronous impedance. The instantaneous rush of current, which takes place at the instant of short-circuit, is limited by the resistance and by the leakage reactance of the alternator. This current rush may be twenty or even thirty times as large as the normal full-load current (Chapter VIII).

Measurements for a short-circuit characteristic should be made at rated frequency, but a considerable variation in the frequency will produce a relatively small effect on the armature

current. Both the voltage induced in the armature and the synchronous reactance vary as the frequency. Therefore, if it were not for the armature resistance, which is always small compared with the synchronous reactance, a change in the frequency would have little or no effect on the short-circuit current.

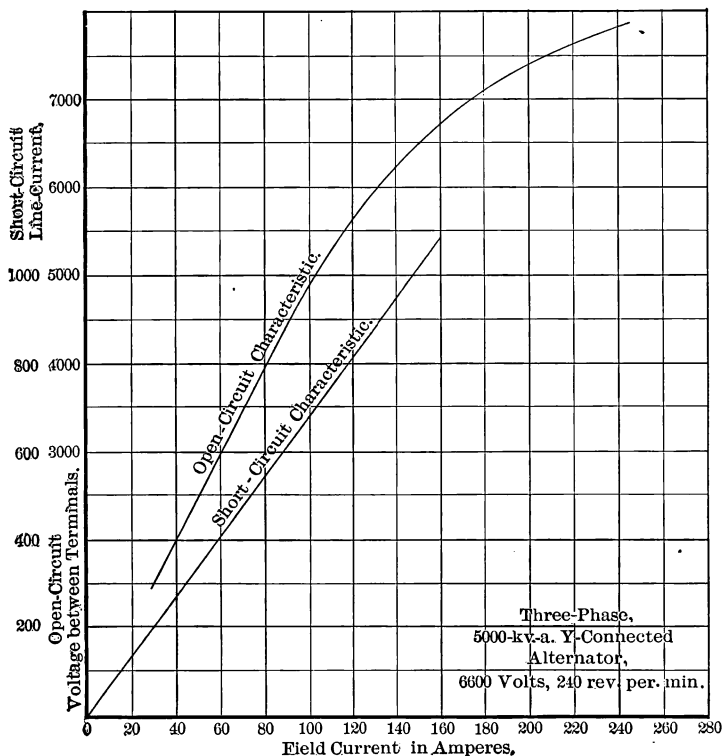

FIG. 51.

Short-circuit characteristics are usually straight lines over the range of saturation through which it is possible to carry them. Although the impressed field may be large, the resultant field, which determines the degree of saturation, is small on account of the large armature reaction caused by the relatively large short-circuit armature current. The effect of the armature reaction of alternators with salient poles will, moreover, be a maximum

on account of the large angle of lag between the current and the generated voltage.

The data for the open- and short-circuit characteristics of the 5000-kv-a., 60-cycle, 6600-volt, Y-connected alternator mentioned on page 87 are given in Table IV. The two characteristics are plotted in Fig. 51.

TABLE IV

Field current	Open-circuit terminal voltage	Short-circuit line current
100	4800	680
150	6500	1020
200	7400	
250	7900	

Examples of the Calculation of the Regulation by the Synchronous-impedance and the Magnetomotive-force Methods.—

The regulation of the 5000-kv-a., Y-connected generator will be calculated by both methods. The constants of this generator are given on page 87. Its open- and short-circuit characteristics are plotted in Fig. 51.

Synchronous-impedance Method.—It is first necessary to find the synchronous reactance. From Fig. 51 take the short-circuit current and the open-circuit voltage corresponding to the largest field excitation used on short-circuit. The current and voltage, for an excitation of 160 amp., are 1085 amp. and 6720 volts respectively. The generator is Y-connected. Therefore, the line voltage must be divided by $\sqrt{3}$ to get the phase voltage. The line current is the phase current.

$$z_s = \frac{\frac{1}{\sqrt{3}}6720}{1085} = 3.58 \text{ ohms.}$$

$$x_s = z_s = 3.58 \text{ ohms approximately.}$$

The regulation will be calculated for a power factor of 0.8 lagging. From Fig. 47, page 91,

$$\begin{aligned} E'_a &= V + I_a (\cos \theta - j \sin \theta)(r_e + jx_s) \\ &= \frac{6600}{\sqrt{3}} + 437(0.8 - j0.6)(0.069 + j3.58) \end{aligned}$$

$$\begin{aligned}
 &= 4773 + j1236 \\
 &= \sqrt{(4773)^2 + (1236)^2} \\
 &= 4931 \text{ volts.}
 \end{aligned}$$

$$\text{Regulation} = \frac{4931 - \frac{6600}{\sqrt{3}}}{\frac{6600}{\sqrt{3}}} 100 = 29.4 \text{ per cent.}$$

The field excitation required for this load is the field current corresponding to a voltage of $4931\sqrt{3} = 8541$ on the open-circuit characteristic. This is beyond the range of the curve.

Magnetomotive-force Method.—Refer to Fig. 49. Use V as an axis of reference.

$$\begin{aligned}
 E''_a &= V + I_a (\cos \theta - j \sin \theta) r_e \\
 &= \frac{6600}{\sqrt{3}} + 437(0.8 - j0.6)0.069 \\
 &= 3835 - j18 \\
 &= 3835 \text{ volts.}
 \end{aligned}$$

The field current corresponding to a voltage of $3835\sqrt{3} = 6642$ on the open-circuit characteristic is 157 amp. This is R'' on the vector diagram. The fictitious armature reaction, A' , is the field current corresponding to an armature current of 437 amp. on the short-circuit characteristic. This field current is 64 amp.

The angle β on the vector diagram is equal to

$$\begin{aligned}
 &90^\circ - \alpha \\
 \sin \alpha &= \frac{18}{3835} \\
 \cos \alpha &= \frac{3835}{3835}
 \end{aligned}$$

The angle α is so small that it may be neglected and β taken as 90 degrees.

$$\begin{aligned}
 F &= A'(-\cos \theta + j \sin \theta) + R''(\cos \beta + j \sin \beta) \\
 &= 64(-0.8 + j0.6) + 157(0 + j1) \\
 &= -51.2 + j195 \\
 &= 202 \text{ amp.}
 \end{aligned}$$

The voltage on the open-circuit characteristic corresponding to this is 7450.

$$\text{Regulation} = \frac{7450 - 6600}{6600} = 12.9 \text{ per cent.}$$

Potier Method.—The vector diagram given in Fig. 46 is known as the Potier Diagram. Although, as has already been pointed out, this diagram is correct only for an alternator with non-salient poles, it often is used in place of some of the more

correct diagrams as an approximate diagram for generators with projecting poles. One of the more correct diagrams is given later.

The Potier method for determining the regulation of an alternator makes use of the vector diagram shown in Fig. 46. The important feature, however, of this method is the manner of separating the armature reaction and the armature leakage reactance.

The terminal voltage of an alternator under load differs from its open-circuit voltage at the same excitation on account

of the change in the field caused by the armature reaction, and also on account of the drop in voltage through the armature produced by the leakage reactance and the armature effective resistance. The relative influence of the three factors depends upon the power factor of the load. With a reactive load at zero power factor, the decrease in the terminal voltage is due almost entirely to the armature reaction and the armature leakage reactance. Under this condition, the effective resistance drop is in quadrature with the terminal voltage and has little influence on the change in the terminal voltage caused by a change in load. This will be made clear by the vector diagram given in Fig. 52 which is for a reactive load of zero power factor.

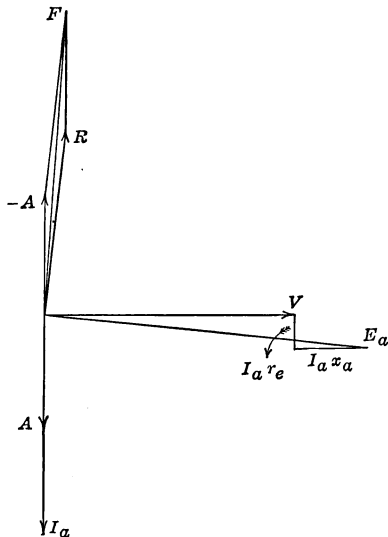

FIG. 52.

The resultant field, R , is almost exactly equal to the algebraic difference between F and A , and the terminal voltage, V , is very nearly equal to the algebraic difference between E_a and $I_a x_a$. Under these conditions, the armature reaction subtracts directly from the impressed field and the armature leakage-reactance drop subtracts directly from the generated voltage.

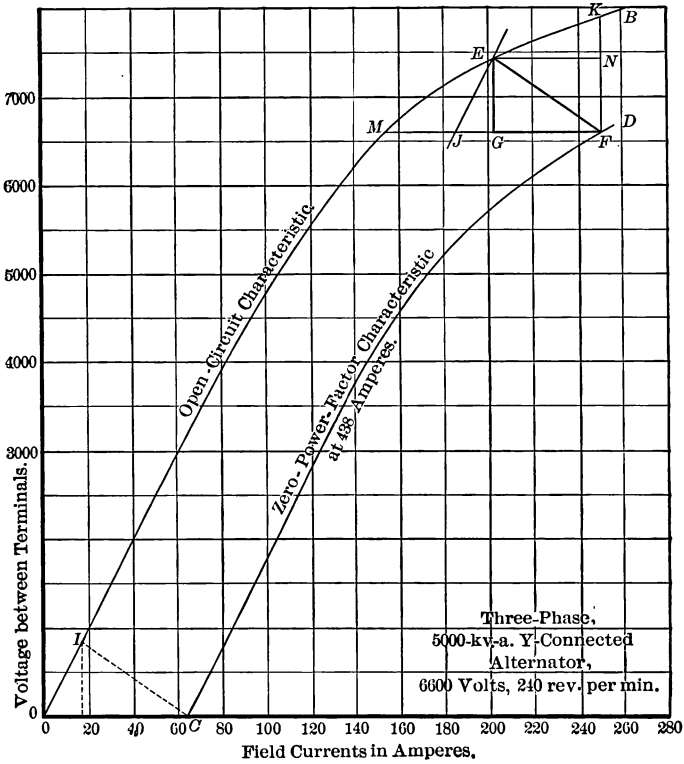

FIG. 53.

The armature resistance drop has no appreciable effect on the terminal voltage. It follows from this that if an open-circuit characteristic, OB , and a curve, CD , showing the variation in the terminal voltage with excitation for the condition of constant armature current at a reactive power factor of zero, be plotted as is shown in Fig. 53 the two curves will be so related that any

two points as E and F , which correspond to the same degree of saturation and consequently to the same generated voltage, will be displaced from one another horizontally by an amount equal to the armature reaction and vertically by an amount equal to the leakage-reactance drop.

GF represents the armature reaction in equivalent field amperes, provided the excitation is plotted in amperes, and GE represents the leakage-reactance drop in volts.

Let the curve CD be for an armature current I' . Then the armature reaction for any current, I_a , will be

$$A = I_a \frac{GF}{I'} = I_a k$$

and, since the plot is for a Y -connected alternator, the armature leakage-reactance voltage per phase for the current I_a will be

$$I_a x_a = I_a \frac{EG}{\sqrt{3}I'}$$

$$\frac{EG}{\sqrt{3}I'} = x_a$$

is the armature leakage reactance per phase.

It has been shown experimentally that the open-circuit curve and the load characteristic at zero power factor, as curve CD is called, are sensibly the same shape and may be made to coincide if superposed.¹ This would be expected, since, at zero power factor, the effect of a fixed armature reaction should be independent of the degree of saturation of the armature and field as the axis along which it acts is fixed and coincides with the axis of the field poles. The leakage reactance of alternators with open slots, as are ordinarily used, should be nearly independent of the degree of saturation of the armature teeth.

In order to make use of the Potier method, it is necessary to find some means of locating two points, one on each curve, corresponding to the same generated voltage and the same resultant field. There are two ways by which this can be done.

First Method.—Make a tracing of the open-circuit characteristic and the co-ordinate axes and mark some point, such as E Fig. 53, which is well up on the bend of the characteristic, on both the open-circuit characteristic and its tracing. Lay the tracing

¹ L'Éclairage Electrique, Vol. XXIV, p. 133.

on the plot. Then, keeping the axes on the tracing parallel with the axes on the plot, slide the tracing about until the traced curve coincides with the load characteristic CD . Then prick the point E through on to the load characteristic. By drawing the right-angle triangle EGF with its base parallel to the axis of abscissæ, the armature reaction and the leakage-reactance drop may be determined.

The complete load characteristic is not necessary. Two points on this curve are sufficient, provided one of them, F , is well up on the bend of the curve. The other point is preferably the point C . This latter point corresponds to the condition of short-circuit. The tracing is made as before but the point E is left off. The tracing is now moved parallel to itself until it touches the two points C and F . By transferring the point F to the tracing and then superposing the tracing on the open-circuit curve, the point E may be located.

Second Method.—Since the two curves, Fig. 53, are parallel, the small right-angle triangle EGF will fit anywhere between them. Let it be moved down until its base lies on the line OC . It is shown dotted in this position. A new triangle OIC is formed with the lower part of the open-circuit characteristic. This new triangle has a definite base OC . From the point F draw a line FJ parallel and equal to OC . Through J draw another line parallel to the lower part of the open-circuit characteristic. The intersection of this latter line with the open-circuit curve will locate the point E of the desired triangle. It will be seen that, unless the point E is taken well up on the bending part of the curve, the line JE will be nearly parallel to the open-circuit characteristic and the intersection between JE and the open-circuit characteristic will not be at all definite.

The Potier method for determining experimentally the armature reaction and armature leakage reactance of an alternator determines these quantities under approximately normal saturation but at a power factor which is very much below that met in practice. For this reason, the value of the armature reaction obtained will be too large in the case of alternators with salient poles.

In practice it is impossible to obtain a load of zero power factor for determining a point as F on the load characteristic,

but power factors sufficiently low may be obtained by using an under-excited synchronous motor operated at no load.

American Institute Method.—The 1907 Standardization Rules of the American Institute of Electrical Engineers recommend the use of the magnetomotive-force method for calculating the regulation of an alternator. The revised Standardization Rules which were adopted by the American Institute of Electrical Engineers in 1914 recommend a modification of the synchronous-impedance method. The only essential difference between this modified method and the regular synchronous-impedance method is that the synchronous impedance used is obtained at normal saturation instead of at low saturation. It is found from one point on the zero-power-factor load characteristic and one point on the open-circuit characteristic.

Let the point F , Fig. 53, be a point at normal voltage on the zero-power-factor load characteristic for the armature current at which the regulation is desired. From F draw a vertical line intersecting the open-circuit curve at K . The distance FK represents the total change in voltage, at zero power factor, caused by armature reaction and the armature leakage-reactance drop. It is the synchronous-impedance drop. Since the curves shown on Fig. 53 are for a Y -connected alternator and are plotted in terms of the voltage between lines, the synchronous impedance per phase is

$$\frac{FK}{\sqrt{3}I} \text{ ohms}$$

where I is the line current. If the machine had been Δ -connected, the line current, I , would have had to have been divided by $\sqrt{3}$ instead of the voltage FK . The distance FK may be divided into its two components by drawing a horizontal line through E intersecting FK at N . FN is then the leakage-reactance drop. NK is the drop in voltage which replaces the effect of the armature reaction. Having found x_s , the regulation may be calculated in the usual way.

The American Institute Method of getting synchronous reactance avoids the chief source of error in the value of synchronous reactance calculated from short-circuit data, namely, the error due to low saturation. The error due to low power factor which was mentioned in the discussion of the regular synchronous-

impedance method is still present unless the machine has non-salient poles.

Example of the Calculation of the Regulation by the American Institute Method.—Referring to Fig. 53,

$$x_s = \frac{FK}{\sqrt{3} I} = \frac{1300}{\sqrt{3} 438} = 1.71 \text{ ohms.}$$

$$E'_a = \frac{6600}{\sqrt{3}} + 437(0.8 - j0.6)(0.069 + j1.71)$$

$$= 4282 + j580$$

$$= 4321 \text{ volts.}$$

$$\text{Regulation} = \frac{4321 - \frac{6600}{\sqrt{3}}}{\frac{6600}{\sqrt{3}}} 100 = 13.4 \text{ per cent.}$$

Value of A' of the Magnetomotive-force Method for Normal Saturation.—The fictitious magnetomotive force A' used in the magnetomotive-force method may be obtained at normal saturation from two points, one on the zero-power-factor curve and one on the open-circuit characteristic.

If the voltage is to be kept constant when a zero-power-factor load is applied to a generator, the field current must be increased to balance the demagnetizing effect of armature reaction and to produce the increase in the generated voltage required to balance the leakage-reactance drop. MF , Fig. 53, represents this increase in field excitation. GF is the part of this increase required to balance the effect of armature reaction. MG is the part required to cause the increase in generated voltage needed to balance the leakage-reactance drop, FN .

When A' is obtained from a short-circuit test, the magnetomotive-force method is an optimistic method since it gives a regulation which is usually better than that found from a load test. When, however, A' is found from a test made with the generator on a highly inductive load, the magnetomotive-force method becomes a pessimistic method if the generator has salient poles. The part MG of $MF = A'$ on Fig. 53 which replaces the leakage-reactance drop is correct since it is for normal saturation. The other part GF , which is the field current

required to balance armature reaction is too large, when the generator has salient poles, since with such a generator armature reaction has its maximum effect in modifying the field at zero power factor and has a greater effect than it does at any normal operating power factor. As a result $MF = A'$ is too large for ordinary power factors.

Example of the Calculation of the Regulation by the Magneto-motive-force Method Using the Value of A' Obtained from a Zero-power-factor Test.—From Fig. 53, A' corresponding to 6600 volts is 96 amp. From page 99, $E''_a = 3835$.

$$\begin{aligned} F &= A'(-\cos \theta + j \sin \theta) + R''(\cos \beta + j \sin \beta) \\ &= 96(-0.8 + j0.6) + 157(0 + j1) \\ &= -76.8 + j214.6 \\ &= 228 \text{ amp.} \end{aligned}$$

From the open-circuit curve (Fig. 53, page 101), $E'_a = 7700$ volts.

$$\text{Regulation} = \frac{7700 - 6600}{6600} 100 = 16.7 \text{ per cent.}$$

Blondel Two-reaction Method for Determining the Regulation of an Alternator.—The armature reaction of an alternator with non-salient poles shifts the axis of the field flux and modifies the field strength without distorting it to any extent. In a generator with salient poles, however, the armature reaction not only modifies the field strength, but, except in the case of zero power factor with respect to the excitation voltage, it also distorts the field by crowding the flux toward one pole tip and away from the other. The effects of the armature reaction of alternators with salient poles have already been discussed and are shown in Figs. 33, 34, 37, 38 and 39, Chapter IV.

If the armature current of an alternator is in phase with its excitation voltage, *i.e.*, with the voltage which would be produced on open-circuit by the impressed field, the armature reaction caused by that current merely distorts the field without modifying its strength. On the other hand, if the power factor is zero with respect to the excitation voltage, the armature reaction will modify the strength of the field without producing distortion. It is, therefore, convenient to resolve the armature reaction of

an alternator with salient poles into two quadrature components: one producing only distortion, the other producing only a change in the field strength. To take account of the two effects of the armature reaction of alternators with salient poles, Blondel suggested the two-reaction theory.¹ Since the magnetomotive force of armature reaction is in phase with the armature current, resolving it into the two components just mentioned is equivalent to considering the armature current to be resolved into two quadrature components. If I_a is the armature current, the two components into which it should be resolved are

$$I_a \sin \varphi$$

and

$$I_a \cos \varphi$$

where φ is the phase angle between the current I_a and the voltage corresponding to the field excitation, *i.e.*, the excitation voltage. The magnetomotive force of the first component, $I_a \sin \varphi$, acts on the same magnetic circuit as the coils on the field poles and its effect is the same as adding an equivalent number of ampere-turns to the field winding. It merely strengthens or weakens the field according as the current leads or lags. The second component, $I_a \cos \varphi$, produces only distortion, and the axis of its magnetomotive force lies midway between the poles. This magnetomotive force acts on a magnetic circuit of high reluctance on account of the large air gap introduced by the interpolar space.

If there are Z inductors per pole per phase, all concentrated in a single pair of slots, the magnetomotive force in ampere-turns per pole per phase due to the maximum phase current of $\sqrt{2} I_a$ is

$$\sqrt{2} I_a \frac{Z}{2}$$

I_a is the effective current per phase in amperes. This magnetomotive force is uniform between the pair of slots considered and its shape is rectangular as shown in Fig. 54. The length of this rectangular magnetomotive-force wave is, of course, equal to π for a full-pitch winding and its height is $\sqrt{2} I_a \frac{Z}{2}$.

The Fourier series which represents the space distribution of

¹ Transactions of the International Congress at St. Louis, 1904, p. 635.

the magnetomotive-force wave due to the Z inductors considered is

$$\frac{4}{\pi} \left\{ \sqrt{2} I_a \frac{Z}{2} \right\} \left\{ \sin y + \frac{1}{3} \sin 3y + \frac{1}{5} \sin 5y + \text{etc.} \right\} \quad (28)$$

To simplify the calculation, all terms except the fundamental will be neglected. This probably will not introduce any great error, especially in the case of a three-phase alternator, since in this case the sum of the third harmonics is zero for balanced load.

The maximum ordinate of the fundamental of the magnetomotive-force wave is

$$\frac{4}{\pi} \sqrt{2} I_a \frac{Z}{2} = 0.9 I_a Z \quad (29)$$

In case the winding is distributed instead of being concentrated as was assumed, equation (29) must be multiplied by a factor

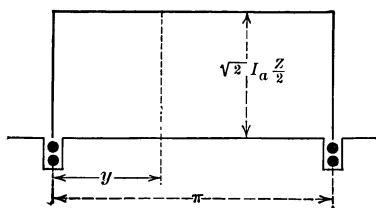

FIG. 54.

k_b to take into account the distribution of the winding. Some of these factors are given in Table I, page 41, for voltage. They are obviously the same for magnetomotive force.

Considering the armature reaction of any one phase as an oscillating vector, and resolving it into two revolving vectors as was done in the previous discussion of armature reaction, gives for the maximum space ordinate of the armature reaction of an alternator with m phases

$$0.45 k_b I_a Z m$$

If Z is considered to be the total number of inductors per pole in all phases instead of the number per phase, this reduces to

$$0.45 k_b I_a Z \quad (30)$$

The direct, or demagnetizing, and the distorting, or cross-magnetizing, components of this reaction are respectively,

$$A_D = 0.45 k_b I_a Z \sin \varphi \quad (31)$$

and

$$A_C = 0.45 k_b I_a Z \cos \varphi \quad (32)$$

The curve representing the direct component of the reaction with respect to a pole is shown in Fig. 55.

The magnetomotive force is not constant over the pole but varies according to the sine law. Since it is not constant, it is necessary to determine its average value over the pole shoe in order to find its effect in modifying the field. The portion of the magnetomotive-force curve which is effective in modifying the field is shaded in Fig. 55. In reality this shaded portion should extend a little beyond the pole shoe on each side to allow for the fringing of the flux. The amount of this fringing is not very definite and its effect will be neglected. The mean value of the ordinates of the shaded portion of the curve of magnetomotive force shown in Fig. 55 is the magnetomotive force which must be added to the magnetomotive force impressed on the

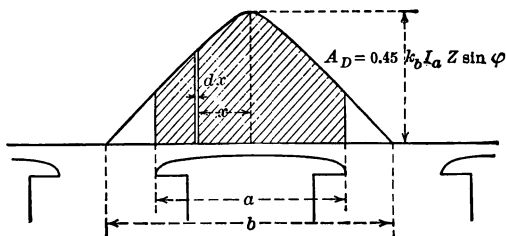

FIG. 55.

field poles to balance the demagnetizing component of the armature reaction. This mean ordinate is

$$A'_D = \frac{0.45 k_b I_a Z \sin \varphi}{\frac{a\pi}{b}} \int_{x = -\frac{a\pi}{b}}^{x = +\frac{a\pi}{b}} \cos x dx$$

$$= 0.45 k_b I_a Z \sin \varphi \frac{\sin \frac{a\pi}{b}}{\frac{a\pi}{b}} \quad (33)$$

$$= (k_b I_a Z \sin \varphi) K_D \quad (34)$$

where

$$K_D = 0.45 \frac{\sin \frac{a\pi}{b}}{\frac{a\pi}{b}} \quad (35)$$

K_D is 0.45 times the factor by which the direct component of the reaction must be multiplied in order to take into account the ratio of the pole arc to the pole pitch.

While the demagnetizing component of the armature reaction acts directly on the main field to increase or decrease the flux according as the current in the armature leads or lags behind the

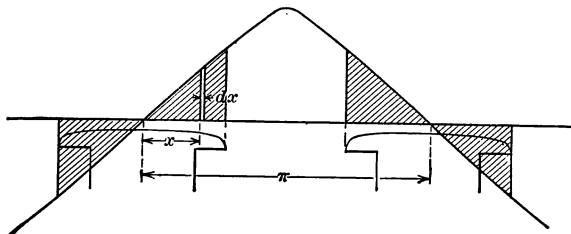

FIG. 56.

excitation voltage, the cross-magnetizing or distorting component of the armature reaction neither increases nor decreases the field excitation as a whole, but increases the magnetomotive force acting over one-half of each pole face and decreases, by an equal amount, the magnetomotive force acting over the other half of each pole face. The cross-magnetizing component,

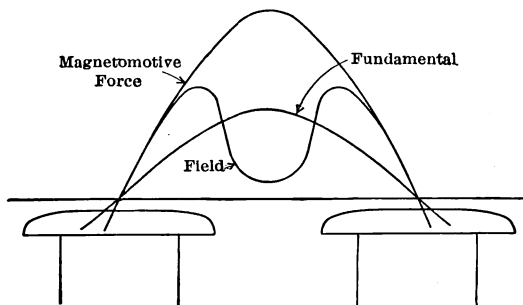

FIG. 57.

$A_C = 0.45k_b I_a Z \cos \varphi$, of the magnetomotive force of armature reaction is plotted in Fig. 56. The shaded portion of this figure shows the part of the cross magnetomotive force which is really effective.

The actual shape of the flux produced by the cross component of armature reaction is shown in Fig. 57. The cross component

of the magnetomotive force tends to produce a local or component flux which passes across one-half of the air gap, then through the pole shoe and back across the other half of the air gap. The circuit is completed through the armature. This local or distorting flux will be constant for any given armature current and will be fixed with respect to the poles, and it will, therefore, revolve with them and produce an electromotive force in the armature winding. This electromotive force will be used on the vector diagram in place of the distorting magnetomotive force of the armature reaction.

In order to find the voltage produced by the cross field, the effective part of the cross magnetomotive force of the armature reaction, *i.e.*, the shaded portion on Fig. 56, will be resolved into a Fourier series and all terms above the fundamental will be neglected. The magnetomotive force of the distorting component of the armature reaction, the field produced by this and its fundamental component are shown in Fig. 57.

The amplitude of the fundamental corresponding to the shaded portion of Fig. 56 is

$$M = \frac{2}{\pi} \int_0^{\pi} f(x) \sin x \, dx \tag{36}$$

For the wave form given in Fig. 56, $f(x)$ is equal to $A_C \sin x$ between the limits of $x = 0$ and $x = \frac{a\pi}{b2}$, and also between the limits of $x = \pi - \frac{a\pi}{b2}$ and $x = \pi$. Between $x = \frac{a\pi}{b2}$ and $x = \pi - \frac{a\pi}{b2}$, $f(x)$ is equal to zero. A_C is given by equation (32), page 108.

$$\begin{aligned} M &= \frac{2}{\pi} A_C \left\{ \int_0^{\frac{a\pi}{b2}} \sin^2 x \, dx + \int_{\pi - \frac{a\pi}{b2}}^{\pi} \sin^2 x \, dx \right\} \\ &= \frac{2}{\pi} A_C \left\{ \left[\frac{1}{2} x - \frac{1}{4} \sin 2x \right]_{x=0}^{x=\frac{a\pi}{b2}} \right. \\ &\quad \left. + \left[\frac{1}{2} x - \frac{1}{4} \sin 2x \right]_{x=\pi - \frac{a\pi}{b2}}^{x=\pi} \right\} \\ &= A_C \left\{ \frac{a}{b} - \frac{1}{\pi} \sin \frac{a\pi}{b} \right\} \end{aligned} \tag{37}$$

Since this magnetomotive force does not alter the total field

strength, it will be replaced on the vector diagram by the voltage it would produce. This voltage is found from the open-circuit characteristic, and is the voltage corresponding to the mean value of the magnetomotive force given by equation (37).

Since this magnetomotive force is sinusoidal, its mean value is $\frac{2}{\pi}$ times its maximum value or is equal to

$$\frac{2}{\pi} M = \frac{2}{\pi} A_C \left\{ \frac{a}{b} - \frac{1}{\pi} \sin \frac{a\pi}{b} \right\} \tag{38}$$

Its form factor as well as the form factor of the voltage produced by it is 1.11. If the form factor of the voltage produced by the air-gap flux on open circuit is different from this, equation (38) must be multiplied by the ratio $\frac{1.11}{k_f}$, where k_f is the form factor for the open-circuit voltage, before the magnetomotive force given by this equation can be used on the open-circuit characteristic.

The complete expression for the cross component of this reaction is

$$\begin{aligned} A'_C &= 0.45k_b I_a Z \cos \varphi \frac{1.11}{k_f} \frac{2}{\pi} \left\{ \frac{a}{b} - \frac{1}{\pi} \sin \frac{a\pi}{b} \right\} \\ &= (k_b I_a Z \cos \varphi) K_C \end{aligned} \tag{39}$$

where

$$K_C = \frac{1}{\pi k_f} \left\{ \frac{a}{b} - \frac{1}{\pi} \sin \frac{a\pi}{b} \right\} \tag{40}$$

K_C is 0.45 times the factor by which the cross component of the armature magnetomotive force must be multiplied in order that it may be used on the open-circuit characteristic. The component flux due to the cross component of the reaction is only slightly affected by the degree of saturation of the main magnetic circuit.

TABLE V

$\frac{a}{b} = \frac{\text{pole arc}}{\text{pole pitch}}$	1	0.8	0.75	0.7
$K_D = 0.45 \frac{\sin \frac{a\pi}{b2}}{\frac{a\pi}{b2}}$	0.29	0.34	0.35	0.36
$K_C = \frac{1}{\pi k_f} \left\{ \frac{a}{b} - \frac{1}{\pi} \sin \frac{a\pi}{b} \right\}$	$\frac{0.32}{k_f}$	$\frac{0.19}{k_f}$	$\frac{0.17}{k_f}$	$\frac{0.14}{k_f}$

The lower part of the magnetization curve, therefore, should be used in finding the voltage produced by it.

The numerical values of the constants K_D and K_C are given in Table V for a number of different ratios of pole arc to pole pitch.

The usual ratio of pole arc to pole pitch is about 0.75. K_D corresponding to this is 0.35 and is used in connection with ampere-conductors (see equation (34), page 109). If Z in equation (34) is changed to turns, the constant K_D must be multiplied by 2 making it 0.70. This is very nearly equal to the constant 0.707

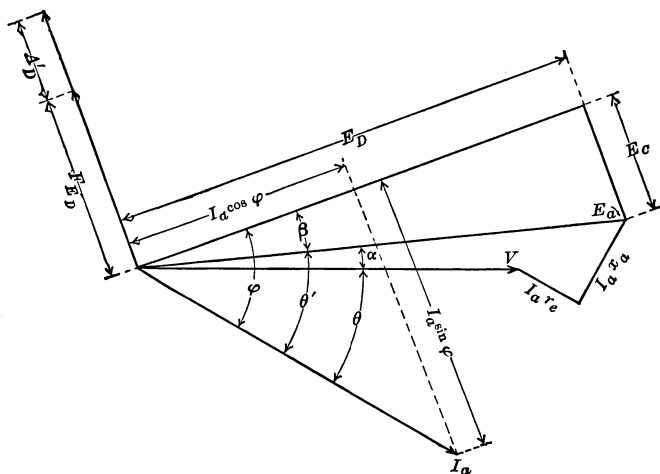

FIG. 58.

which was used in the calculation of the regulation by the general method. It may be one reason why the constant 0.707 for the armature reaction used in connection with the general method for calculating the regulation of alternators with salient poles gives fairly satisfactory results. The armature reaction obtained from the Potier triangle is in reality the direct component of the armature reaction used in the Blondel double-reaction method and corresponds to A'_D given by equation (34).

The vector diagram of the two-reaction method is given in Fig. 58.

The generated voltage, E_a , is found in the usual manner by adding the resistance and the leakage-reactance drops to the ter-

minimal voltage V . In the two-reaction method of Blondel, the electromotive force, E_a , is considered to be the resultant of two quadrature components: one, E_C , induced by the flux produced by the transverse component of the armature reaction, and the other, E_D , induced by the flux from the main poles.

For the present, assume that the angles made by these components with E_a are known. E_a may then be resolved into its two components E_D and E_C . Having obtained E_D , the excitation, F_{E_D} , required on the main poles to produce this voltage may be found from the open-circuit characteristic by looking up the field magnetomotive force on that curve corresponding to the voltage E_D . The real excitation under load must be greater than this (an inductive load assumed) to balance the direct component, A'_D (equation 34), of the armature reaction. The cross component, A'_C (equation 39), of the armature reaction merely distorts the field without altering its strength. Therefore, the impressed field is

$$F = F_{E_D} + A'_D$$

where F , F_{E_D} and A'_D are considered in a purely algebraic sense. If E'_a is the voltage on the open-circuit curve corresponding to the field F , the regulation is

$$\frac{E'_a - V}{V} \text{ 100 per cent.}$$

The angle β , which it is necessary to know in order to divide E_a into its two components, E_D and E_C , may be found in the following manner. Find the volts generated per ampere turn on the lower part of the open-circuit characteristic. Call this voltage v . For reasons already given, v will be assumed constant. Calculate A'_C by equation (39). Then

$$\begin{aligned} E_C &= vA'_C \\ &= v 0.45k_b I_a Z \cos \varphi \frac{2.22}{k_f \pi} \left\{ \frac{a}{b} - \frac{1}{\pi} \sin \frac{a\pi}{b} \right\} \\ &= QI_a \cos \varphi \\ &= QI_a \cos (\beta + \theta') \end{aligned} \tag{41}$$

where

$$Q = vk_b Z K_C$$

From Fig. 58,

$$E_C = E_a \sin \beta \tag{42}$$

Combining equations (41) and (42) gives

$$E_a \sin \beta = QI_a \cos (\beta + \theta')$$

and

$$\tan \beta = \frac{QI_a \cos \theta'}{E_a + QI_a \sin \theta'} \quad (43)$$

$$\theta' = \theta + \alpha \quad (\text{Fig. 58}).$$

Therefore, β can be found for any given armature current, I_a , and load power-factor angle θ .

Example of the Calculation of Regulation by the Two-reaction Method.—The regulation of the 5000-kv-a., 6600-volt, three-phase, Y-connected generator which has already been used will be calculated. The rating and constants of this generator are given on page 87. The ratio of the pole arc to the pole pitch is 0.768. A full kv-a. load at 0.8 (lagging) power factor will be assumed. Refer to Fig. 58.

The generated voltage was found, in the calculation of the regulation by the general method, to be

$$E_a = 3900 + j70.3$$

$$= 3901 \text{ volts}$$

$$\sin \alpha = \frac{70.3}{3901} = 0.0180$$

$$\alpha = 1^\circ 1'$$

$$\cos \theta = 0.8$$

$$\theta = 36^\circ 52'$$

and

$$\theta' = \theta + \alpha = 37^\circ 53'$$

$$\sin \theta' = 0.614$$

$$\cos \theta' = 0.789$$

and

$$K_D = 0.45 \frac{\sin \left(0.768 \frac{\pi}{2} \right)}{0.768 \frac{\pi}{2}} = 0.349$$

$$K_C = \frac{1}{\pi k_f} \left\{ 0.768 - \frac{1}{\pi} \sin (0.768\pi) \right\} = 0.160$$

From equation (43)

$$\tan \beta = \frac{QI_a \cos \theta'}{E_a + QI_a \sin \theta'}$$

$$Q = vk_b Z K_C$$

From the lower part of the open-circuit curve of this generator, the data for which are given in Table IV, $v = \frac{4800}{\sqrt{3} \times 100 \times 67.5}$
 $= 0.41$ volt per ampere-turn per pole. Q is then equal to
 $Q = 0.41 \times 0.96 \times 24 \times 0.160 = 1.51$

and

$$\begin{aligned}\tan \beta &= \frac{1.51 \times 437 \times 0.789}{3901 + 1.51 \times 437 \times 0.614} = 0.1209 \\ \beta &= 6^\circ 53' \\ E_D &= E_a \cos \beta \\ &= 3901 \times 0.993 \\ &= 3880\end{aligned}$$

The field excitation corresponding to a voltage $3880\sqrt{3}$ on the open-circuit curve of this generator, which is plotted in Fig. 51, page 97, is 160 amp.

$$\begin{aligned}\varphi &= \theta + \alpha + \beta = 44^\circ 46' \\ \sin \varphi &= 0.704 \\ A'_D &= k_b I_a Z \sin \varphi K_D \\ &= 0.96 \times 437 \times 24 \times 0.704 \times 0.349 \\ &= 2474 \text{ ampere-turns per pole.}\end{aligned}$$

The impressed field, F , in amperes is

$$160 + \frac{2474}{67.5} = 197$$

The open-circuit voltage corresponding to this is 7360 between terminals. The regulation is, therefore,

$$\frac{7360 - 6600}{6600} 100 = 11.5 \text{ per cent.}$$

The values of the regulation of the 5000-kv-a., 6600-volt, three-phase alternator calculated by the different methods given in this chapter are brought together in Table VI for comparison.

TABLE VI

Method	Per cent. regulation at unit power factor	Per cent. regulation at 0.8 power factor
General.....	3.0	11.4
Synchronous-impedance, using short-circuit data.....	9.4	29.4
Magnetomotive-force, using short-circuit data.....	4.6	12.9
Synchronous-impedance, using zero-power-factor load.....	2.7	13.4
Magnetomotive-force, using zero-power-factor load.....	9.1	16.7
Blondel double-reaction.....	3.0	11.5
By measurement.....	4.1	

CHAPTER VI

SHORT-CIRCUIT METHOD FOR DETERMINING LEAKAGE REACTANCE; ZERO-POWER-FACTOR METHOD FOR DETERMINING LEAKAGE REACTANCE; POTIER TRIANGLE METHOD FOR DETERMINING LEAKAGE REACTANCE; DETERMINATION OF LEAKAGE REACTANCE FROM MEASUREMENTS MADE WITH FIELD STRUCTURE REMOVED; DETERMINATION OF EFFECTIVE RESISTANCE WITH FIELD STRUCTURE REMOVED

Short-circuit Method for Determining Leakage Reactance.— Short-circuit the armature and measure the phase current and impressed field at rated frequency for about full-load current.

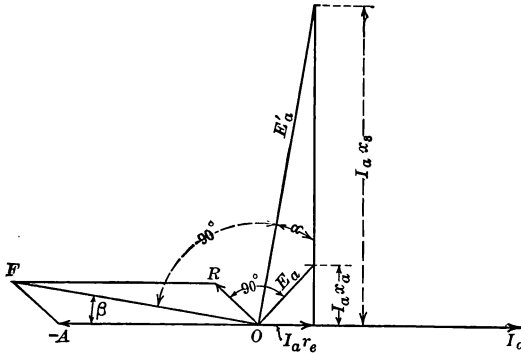

FIG. 59.

The vector diagram for a short-circuited alternator is shown in Fig. 59. E'_a is the voltage on open circuit which corresponds to the impressed field F .

$$R^2 = F^2 + A^2 - 2FA \cos \beta \quad (44)$$

$$\beta = \alpha$$

$$\sin \beta = \sin \alpha = \frac{I_a r_e}{E'_a}$$

The armature reaction, A , may be calculated from equation

(10), page 59, but it is better to calculate it from equation (34), page 109, which gives the direct component of the armature reaction used in the double-reaction method for determining the regulation of an alternator. On short-circuit the angle of lag between the phase current and the excitation voltage is very large and, in consequence of this, the distorting component of the armature reaction is very small and can be neglected. When equation (34), is applied to a generator having non-salient poles, the ratio of pole arc to pole pitch, *i.e.*, $\frac{a}{b}$ in equation (34), is determined by the arrangement of the field winding.

By substituting the numerical values of F , A and β in equation (44) the resultant field R may be found. The angle β is small and usually may be neglected.

$$R = F - A \text{ approximately.}$$

Let E_a be the voltage on the open-circuit curve corresponding to R . Then

$$x_a = \sqrt{\left(\frac{E_a}{I_a}\right)^2 - r_e^2}$$

The effective resistance, r_e , can be found by one of the methods which will be given later.

The chief objections to the short-circuit method for determining the leakage reactance are the low degree of saturation and the low power factor for which the reaction is obtained. The objections are not of so great importance as might at first seem, since the reactance of ordinary alternators with open slots is not greatly affected by the degree of saturation of the armature teeth.

Zero-power-factor Method for Determining Leakage Reactance.—When an alternator is operated on a reactive load at zero power factor, the axis of the armature-reaction magnetomotive force very nearly coincides with the axis of the impressed field and the two magnetomotive forces may be subtracted directly to give the resultant field. This has already been referred to in the Potier method for separating the effects of armature reaction and armature leakage reactance. Referring to Fig. 52, page 100, which is the vector diagram of an alternator supplying a highly inductive load, it will be seen that the algebraic relation

$$R = F - A$$

is very nearly correct. The armature reaction, A , as in the case of the short-circuit method for determining leakage reactance, is best found from equation (34), page 109.

E_a is the voltage generated by the resultant field, R , and is equal to the voltage corresponding to an excitation, R , on the open-circuit characteristic. Again referring to Fig. 52, it will be seen that the following algebraic relation is very nearly correct:

$$E_a - V = I_a x_a$$

from which

$$x_a = \frac{E_a - V}{I_a}$$

The highly inductive load required for the zero-power-factor method of determining the leakage reactance may be obtained by using as a load for the alternator an under-excited synchronous motor operating without load.

The zero-power-factor method of determining the leakage reactance is not so simple to apply as the short-circuit method, but it has the advantage of giving the reactance for about normal saturation. The effect of the low power factor under which the reactance is obtained will tend to make the measured value of the reactance of alternators with salient poles slightly larger than it would be under ordinary operating power factors.

If the equivalent leakage flux is desired, it can be found by making use of equation (26), page 78.

Potier Triangle Method for Determining Leakage Reactance.—This method has already been given in Chapter V.

The Determination of Leakage Reactance from Measurements Made with the Field Structure Removed.—An approximate value of the leakage reactance of the armature of an alternator may be obtained by removing the field structure and measuring the voltage, V , required to send about full-load current through the armature. The ratio of this voltage to the current will be approximately equal to the armature leakage impedance.

$$z_a = \frac{V}{I_a}$$

$$x_a = \sqrt{z_a^2 - r_e^2}$$

If r_e is known, x_a may be found.

The method just outlined for determining the leakage reactance of an alternator assumes that the leakage flux of the armature for a fixed armature current is the same whether the field structure is in place or removed. This assumption is probably not far from correct in many cases, since the only part of the leakage which would be affected materially by the removal of the field is the tooth-tip leakage. In addition to the leakage flux, a second flux is caused by armature reaction which passes between the poles produced on the armature by the armature current. The voltage induced in the armature inductors by this second flux is not a part of the leakage-reactance voltage and should not be included in it. With the field structure in place, this flux combines with the flux caused by the impressed field to produce the resultant field and it has nothing to do with the voltage drop through the armature. Although the voltage induced by this flux is included in the value of x_a obtained by the method just described, the error introduced by it in the measured value of x_a is probably not large, since the armature-reaction flux will be small when the field structure is removed on account of the high reluctance of its magnetic circuit under this condition. With the field structure in place, the effect of this flux would be very large.

The Determination of the Effective Resistance with the Field Structure Removed.—If the power consumed by the armature is measured when the field structure is removed and a current, I_a , passed through it, the effective resistance may be found by dividing the power, P , per phase by the square of the phase current, I_a ,

$$r_e = \frac{P}{I_a^2}$$

This assumes that the armature-reaction flux is negligible so that the core loss is entirely due to the leakage flux. It also assumes that the core loss produced by a given change in flux is independent of whether that flux acts alone or in conjunction with another flux. When the field structure is removed, the core loss in the teeth is that caused by the leakage flux. This is the only flux which exists. Under this condition, all of the core loss in the teeth is effective in increasing the apparent resistance. Under operating conditions, the core loss in the

teeth is due to the resultant variation of the flux in the teeth caused by the leakage flux superposed upon the flux from the field poles. Only that part of this loss which is due to the leakage flux contributes to the loss caused by the effective resistance. The increase in the core loss caused by the superposition of the leakage flux can be the same as the core loss produced by the leakage flux when acting alone only when the core loss varies as the first power of the flux density. It actually varies between the 1.6 and 2 powers. Moreover, the superposition of the two fluxes not only changes the magnitude of the tooth flux but changes its distribution as well. A change in the distribution of a flux will alter the core loss produced by it even though the total flux remains unaltered. A second method for determining the effective armature resistance which can be used under certain conditions will be taken up after the discussion of the losses in an alternator.

CHAPTER VII

LOSSES; MEASUREMENT OF THE LOSSES BY THE USE OF A MOTOR; MEASUREMENT OF EFFECTIVE RESISTANCE; RETARDATION METHOD OF DETERMINING THE LOSSES; EFFICIENCY

Losses.—With the exception of the commutator brush-friction loss, an alternator has the same losses as a direct-current generator, and in addition it has certain load losses which are not present in a direct-current machine.

The losses in an alternator may be divided into two general groups, namely: the open-circuit losses and the load losses. The open-circuit losses are those which are present at no load. They are all also present under load, but under load conditions some of them are modified. The load losses are those which are caused either directly or indirectly by the armature current.

The open-circuit losses may be divided into:

- (a) Bearing friction.
- (b) Brush friction.
- (c) Windage loss.
- (d) Hysteresis and eddy-current losses caused by the resultant field.
- (e) Excitation loss.

The load losses may be divided into two groups:

- (f) Armature copper loss due to the ohmic resistance of the armature winding.
- (g) Local core and eddy-current losses caused directly or indirectly by the armature current.

(a) *Bearing Friction.*—The bearing-friction loss is proportional to the length and diameter of the bearing and to the three-halves power of the linear velocity of the shaft. It depends upon many factors such as the condition of the bearings, lubrication, etc., and it varies with the load, especially if the generator is belt-driven. The loss caused by the bearing friction is small and for this reason it is usually assumed to be constant.

(b) *Brush Friction.*—The brush-friction loss is caused by the brushes for the field excitation. On account of the few brushes required and the low rubbing velocity of the slip rings against these brushes, this loss is very small.

(c) *Windage Loss.*—The windage loss is not great except in the case of turbo alternators. It cannot be calculated. All of the friction and windage losses are generally grouped together and determined experimentally or estimated from experimental data obtained from measurements made on similar machines.

(d) *Hysteresis and Eddy-current Losses Caused by the Resultant Field.*—The hysteresis and eddy-current losses caused by the resultant field include all eddy-current and hysteresis losses which are not directly or indirectly due to the armature current. Besides the ordinary eddy-current and hysteresis losses in the armature, there are certain additional eddy-current and hysteresis losses, namely:

1. The eddy-current losses in the armature end plates and bolts and in the frame due to leakage flux which gets into these parts.

2. The pole-face losses caused by the movement of the armature slots by the pole faces. When solid poles are used, as in the case of some large turbo generators, these losses will increase very rapidly as the ratio of the width of the slot opening to the length of the air gap increases. Fig. 60 shows the distribution of the flux across the pole face, at one particular instant, in the case of an alternator with a $\frac{9}{16}$ -in. air gap and armature slots 1 in. wide.

3. The eddy-current losses in the armature conductors caused by the field. The flux entering a slot is not constant but varies with the position of the slot with respect to a pole. It is a maximum when the slot is opposite the center of a pole and a minimum when the slot lies midway between two poles. Fig. 61 shows the approximate direction of the flux lines in the slots and air gap of an alternator at no load. The number of these lines per inch represents in a very crude way the intensity of the field.

The variation in the flux entering a slot will set up eddy currents in the inductors. The voltages producing these eddy currents will be different on the two sides of the slots, and will be greater at the top of the slots than at the bottom. Therefore,

to prevent eddy-current losses due to these differences in voltage, it is necessary to laminate the armature inductors both horizon-

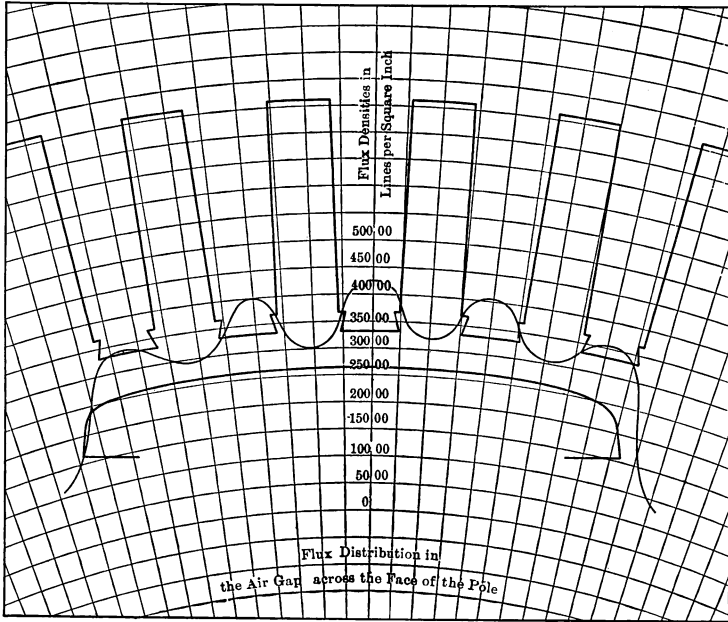

FIG. 60.

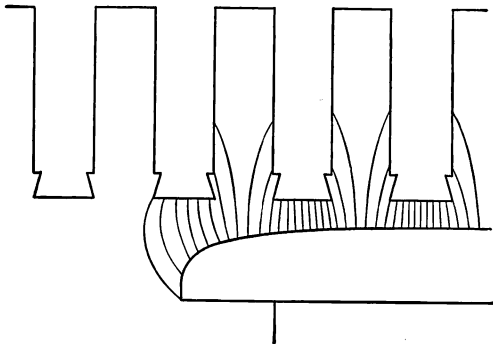

FIG. 61.

tally and vertically. It is not at all important that the laminations should extend to the bottom of the slots, since the flux

entering a slot never penetrates to more than one-third to one-half the depth of the slot. The loss due to these eddy currents is nearly constant and independent of the load, and for this reason it is usually included in the core loss. It is not necessary to laminate the armature inductors except when their cross-section is large as in the case of bar windings. Even when bar windings are used, the inductors are laminated only in one direction, namely, vertically.

(e) *Excitation Loss.*—The excitation loss is the copper loss in the field circuit and is equal to the field current multiplied by the voltage across the field circuit. The loss in the field rheostat is included in the excitation loss. The excitation loss varies both with the load and with the power factor. It will be greatest for inductive loads.

(f) *Armature Copper Loss Due to Ohmic Resistance.*—The armature copper loss is the ordinary $I_a^2 r_a$ loss and may be computed easily from the length, the cross-section and the specific resistance of the armature conductors.

(g) *Local Core Losses Caused by Leakage Flux.*—In addition to the ordinary copper loss in the armature inductors, there are eddy-current losses in these inductors and hysteresis and eddy-current losses in the pole faces and armature teeth which are produced by the leakage flux set up by the armature current. To prevent the eddy-current losses in the armature inductors due to the leakage flux, it is necessary to laminate the armature inductors horizontally. The armature current also causes some eddy-current losses in the end connections and any adjacent metal.

All the eddy-current and hysteresis losses which are directly due to the armature current produce an effect which is equivalent to an apparent increase in the armature resistance, and may be taken into account by using the so-called effective resistance in place of the ohmic when finding the armature copper loss.

Measurement of the Losses by the Use of a Motor.—The open-circuit losses of an alternator, (a) to (d) inclusive, may be determined by driving the alternator on open circuit by a shunt motor. The open-circuit losses corresponding to any excitation are equal to the input to the armature of the motor minus the belt loss, the armature copper loss and the stray power

of the motor. The input to the alternator when its field circuit is open is its friction and windage loss. The difference between the open-circuit losses and the friction and windage losses is known as the open-circuit core loss. It is customary to plot this loss either against voltage or field excitation expressed either in amperes or in ampere turns.

The load losses may be obtained by finding the power required to drive the alternator on short-circuit. All phases should be short-circuited. This power less the friction and windage losses is the load loss. The difference between the load loss and the short-circuit copper loss is known as the stray load losses or short-circuit core loss. These losses depend upon the armature current and should, therefore, be plotted against that current. The stray load losses include all losses due to the armature leakage flux and a small core loss due to the resultant field. The stray load losses under normal operating conditions are usually less than the stray load losses determined on short-circuit for the same armature current. The difference between these losses under the two conditions depends upon many factors; it is greatest in high-speed turbo alternators with solid cylindrical field structures. Although the stray load losses measured on short-circuit are greater than under operating conditions, the revised Standardization Rules (1914) of the American Institute of Electrical Engineers recommends the use of the stray losses measured in that way in calculating the efficiency of polyphase synchronous generators and motors.

Measurement of Effective Resistance.—If the local losses produced by a fixed armature current are assumed to be the same on short-circuit as under normal conditions, the effective resistance of an alternator may be found by dividing the total losses produced by the armature current when the alternator is short-circuited by the number of phases and the square of the armature phase current. The losses caused by the armature current can be found by subtracting the core loss corresponding to the resultant field from the total short-circuit losses exclusive of friction and windage. This method of determining the effective resistance is not very reliable since, with the low field intensity used on short-circuit, the load losses are usually greatly exaggerated. It is, moreover, subject to most of the errors of the

method for measuring effective resistance with the field structure removed (see page 121).

Retardation Method of Determining the Losses.—It is often impossible or impracticable, when dealing with large machines, to drive them by motors to determine their losses. In the case of turbo generators there is often no projecting shaft to which a motor may be attached or belted. Under this condition the retardation method of determining the losses is the only one which can be used.

The kinetic energy of any rotating body is

$$W = \frac{1}{2}\omega^2\mathfrak{J} \quad (45)$$

where W , ω and \mathfrak{J} are, respectively, the kinetic energy, the angular velocity and the moment of inertia of the rotating part.

Differentiating equation (45) with respect to t gives

$$\frac{dW}{dt} = \mathfrak{J}\omega \frac{d\omega}{dt}$$

The derivative of energy with respect to time is power, and the rate of change of angular velocity, *i.e.*, $\frac{d\omega}{dt}$, is angular acceleration. Replacing $\frac{dW}{dt}$ by P , power, and $\frac{d\omega}{dt}$ by α , *i.e.*, by angular acceleration, gives equation (46).

$$P = \mathfrak{J}\omega\alpha. \quad (46)$$

The power, therefore, causing any change in the angular velocity of a rotating body is equal to the moment of inertia of the body multiplied by its angular velocity and by its angular acceleration at the instant considered. If the rotating body is coming to rest, the acceleration will be negative and is called retardation.

The formula $P = \mathfrak{J}\omega\alpha$ may be applied to a motor or a generator to determine the losses, provided the moment of inertia of its rotating part can be found. There are several methods by which the moment of inertia may be determined. One of these is more satisfactory than the others and alone will be given.

If any alternator is brought up above its synchronous speed with armature circuit open and its field circuit closed and is then allowed to come to rest, the retarding power causing it to slow down is its friction and windage and open-circuit core loss. If the angular retardation, *i.e.*, α , is measured at the instant the generator passes through synchronous speed, the friction and windage loss plus the open-circuit core loss corresponding to the excitation used may be calculated from formula (46), provided the moment of inertia is known. If the generator comes to rest without field excitation, the formula will give the friction and windage losses alone.

The chief source of error in the application of the retardation method lies in the determination of the retardation α . In order to find α , it is necessary to take readings for a speed-time curve as the generator slows down. Some form of direct-reading tachometer will be necessary for this. The interval required between the successive readings for the speed-time curve will depend upon the size and speed of the generator being tested, and will vary from 5 seconds for very small machines to as many minutes in the case of the largest turbo alternators. A speed-time curve is plotted in Fig. 62.

If a line *bc* is drawn tangent to the curve at *a*, which is the point of rated speed, the retardation α will be

$$\alpha = \frac{fg}{ed}$$

The simplest and most satisfactory method of finding the moment of inertia is first to measure the open-circuit losses at rated frequency and with some definite field excitation. This can be done by operating the machine as a synchronous motor and adjusting the excitation for unit power factor (Synchronous Motors, page 297). The power input to the armature under this condition is equal to the sum of the friction and windage losses, the core loss corresponding to the excitation used and a very small armature copper loss, which can usually be neglected if the power factor is properly adjusted. Having determined the losses, the speed of the generator is increased 10 or 15 per cent. by increasing the frequency of the circuit from which it is operated or by any other convenient means. The generator is then allowed

to come to rest with its field circuit still closed and its excitation unaltered, and readings are taken for a speed-time curve as the generator slows down.

By substituting in formula (46) the friction and windage and core losses as measured at synchronous speed and the values of ω and α also at synchronous speed, the moment of inertia may be found.

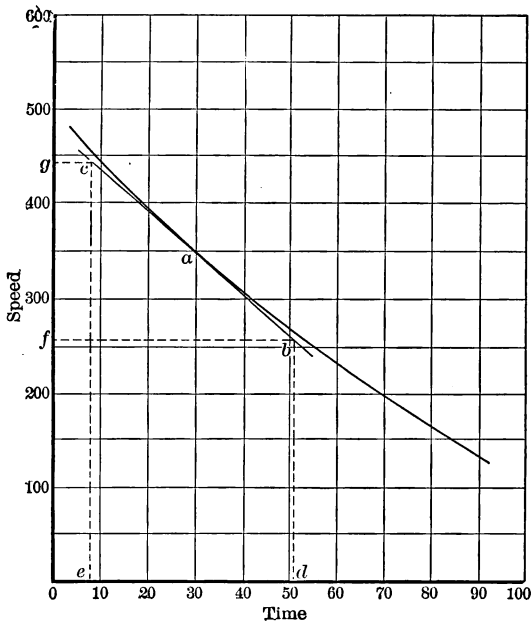

FIG. 62.

Having determined the moment of inertia, the friction and windage losses may be found by taking measurements for a speed-time curve while the generator comes to rest without field excitation. The friction and windage and core loss corresponding to different field excitations may be found by allowing the generator to come to rest with different field excitations. Knowing the friction and windage losses, the open-circuit core losses corresponding to these field excitations may be found.

It is also possible to get the short-circuit losses by letting the generator come to rest with its armature short-circuited and with

a field excitation which will produce the desired short-circuit armature current at synchronous speed. The power found under this condition, minus the friction and windage losses and the I^2r losses in the armature due to its ohmic resistance, is the short-circuit core loss corresponding to the current in the armature when the generator passed through synchronous speed. The armature current will remain very nearly constant over a wide range of speed. The reason for this has already been given under the discussion of the short-circuit characteristic.

Formula (46) will give the power in watts, provided the second member of the formula is multiplied by 10^{-7} and \mathfrak{J} is expressed in c.g.s. units. The angular velocity, ω , and the angular retardation, α , are expressed in radians per second and radians per second per second, respectively. As the method just outlined is purely a substitution method, the units in which P , \mathfrak{J} , ω and α are expressed are of no consequence.

Efficiency.—The efficiency of any piece of apparatus is equal to the ratio of its output to its output plus its losses.

$$\text{Efficiency} = \frac{\text{output}}{\text{output} + \text{losses}} \quad (47)$$

If the losses corresponding to any given output are known, the efficiency corresponding to that output can easily be calculated by means of equation (47). For a three-phase alternator operating under a balanced load, equation (47) may be written

$$\text{Efficiency} = \frac{\sqrt{3VI}(p.f.)}{\sqrt{3VI}(p.f.) + P_c + 3I_a^2r_e + P_{f+w} + I_fV_f} \quad (48)$$

where the letters have the following significance:

V = Terminal voltage.

I = Line current.

I_a = Phase current.

P_c = Open-circuit core loss.

r_e = Effective resistance of the armature per phase.

I_f = Field current.

V_f = Voltage across field including the field rheostat.

$p.f.$ = Power factor.

P_{f+w} = Friction and windage loss.

The field current corresponding to any load may be found by any of the methods already described for determining the regulation. It is best to use the American Institute method. The proper value of the core loss, P_c , is that value, on the curve of open-circuit core loss, which corresponds to a voltage equal to the phase terminal voltage plus the armature-resistance and leakage-reactance drops.

The American Institute of Electrical Engineers recommends that the efficiency of an alternator be calculated by dividing its output by its output plus its losses where the losses are: open-circuit core loss, the copper loss in the field, the friction and windage losses, the armature ohmic copper loss and the stray load losses. Since there is no generally accepted method of determining the armature leakage reactance, it is recommended that the core loss be taken for a voltage corresponding to the terminal voltage plus the armature-resistance drop. It is further recommended that the efficiency be referred to a temperature of 75°C.

CHAPTER VIII

TRANSIENT SHORT-CIRCUIT CURRENT

Transient Short-circuit Current.—The short-circuit current of an alternator, after steady short-circuit conditions have been reached, is limited by the synchronous impedance of the armature. It is equal to the open-circuit voltage, corresponding to the field excitation at which the short circuit occurs, divided by the synchronous impedance.

$$I_{s.c.} = \frac{E'_a}{z_s} = \frac{E'_a}{\sqrt{r_e^2 + x_s^2}} \quad (49)$$

The sustained short-circuit current under conditions of normal excitation is from one and a half to three or four times full-load current, depending upon the type of alternator, the lower value being for large turbo-alternators.

If an alternator is short-circuited while in operation, either under load or at no load, the short-circuit current will not instantly reach the value given by equation (49). The time required for the current to reach approximately the final steady value may be a second or several seconds depending upon the conditions under which the short-circuit takes place and the design of the alternator.

No simple equation for the current can be developed which will hold even approximately during the transient conditions *i.e.*, which will hold from the instant short-circuit occurs to the time when the short-circuit current has reached approximately its final steady value as given by equation (49).

Consider a circuit containing constant resistance and constant inductance but having no mutual inductance. Let the sinusoidal voltage $e = E_m \sin(\omega t + \alpha)$ be impressed on this circuit. The equation for the voltage drop across the circuit is

$$e = E_m \sin(\omega t + \alpha) = ri + L \frac{di}{dt} \quad (49a)$$

This is a linear differential equation of the first order and degree. Its solution for current is

$$i = \frac{E_m}{\sqrt{r^2 + \omega^2 L^2}} \sin(\alpha - \theta) \epsilon^{-\frac{rt}{L}} + \frac{E_m}{\sqrt{r^2 + \omega^2 L^2}} \sin(\omega t + \alpha - \theta) \quad (49b)$$

where the angle θ is fixed by the relation $\tan^{-1} \frac{\omega L}{r}$.

The first term in equation (49b) is a transient. It represents a transient condition. This term becomes sensibly zero in a very short interval of time for a circuit having usual values of r and L . It is a maximum when $(\alpha - \theta) = \frac{\pi}{2}$ or when the circuit is closed $\alpha = \frac{\pi}{2} + \theta$ radians after the electromotive force e has passed through its zero value. The term is zero if the circuit is closed when $(\alpha - \theta) = 0$. In this latter case there is no transient condition. The current starts off with its final or steady value. In other words it reaches its steady value instantly.

The decrease in the transient term in equation (49b) is due to the losses in the circuit. The rate at which it decreases is fixed by $\frac{L}{r}$, the time constant of the circuit. If the effective value of the resistance, r , could be made zero, *i.e.*, if there were no losses, $\frac{L}{r}$ would be equal to infinity and $\epsilon^{-\frac{rt}{L}}$ would be equal to unity. Under this condition the transient would not decrease, but would remain constant at its initial value, that is, at the value it had when t was zero. Its effect would be to permanently displace the axis of symmetry of the current wave from the axis of time. If the ratio of $\frac{L}{r}$ is small, due to either large resistance or small inductance, $\epsilon^{-\frac{rt}{L}}$ will decrease rapidly with time and will quickly become sensibly zero. If $\frac{L}{r} = 0$, as when the inductance L is zero, $\epsilon^{-\frac{rt}{L}} = 0$ and there is no transient. The effect of the transient term is to displace the axis of symmetry of the current wave by an amount which is equal to the value of the transient at the instant considered. The amount of this displacement usually decreases rapidly and becomes sensibly zero after a

very brief interval of time. The resultant current is equal to an alternating current, equal in magnitude to the current in the circuit after steady conditions have been established, superposed upon a direct current of decreasing magnitude and equal at each instant to the transient.

The condition existing when a 25-cycle circuit, having constant resistance and inductance, is closed at the point on the electromotive force wave corresponding to $(\alpha - \theta) = \frac{\pi}{2}$, that is at the point on the electromotive force wave which makes the transient a maximum, is plotted in Fig. 62a. In this figure $\frac{L}{r} = 0.0955$. The transient and steady components of the current are of the same sign and add directly during the first negative loop of the

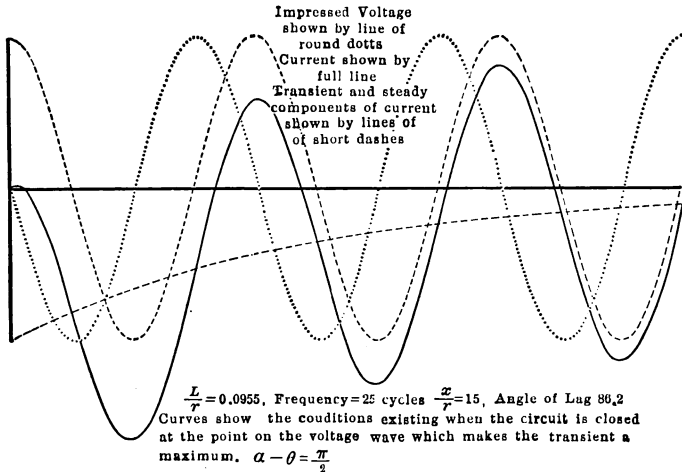

FIG. 62a.

steady component. For the conditions assumed the initial value of the transient is equal to the maximum value of the steady component. This is its maximum possible value.

It is obvious that the maximum value of the resultant current wave will occur during the first negative loop of the steady component. It will be somewhat less than twice the maximum value obtaining after steady conditions have been reached. It is easily seen that the greatest possible maximum value a

current can attain when a circuit containing constant resistance and constant inductance is closed is twice the maximum value corresponding to the steady state. To attain this value the circuit would have to be closed at the point on the electromotive force wave which would make $(\alpha - \theta) = \frac{\pi}{2}$ and the resistance of the circuit would have to be zero. It will have very nearly this value when the resistance is small compared with the inductance, that is, when $\frac{L}{r}$ is large.

When an alternator is short-circuited the load impedance becomes zero and the current is determined by the apparent impedance of the armature. The effect is practically the same whether the alternator is short-circuited under load or at no load. The induced voltage is suddenly impressed on an impedance which is the apparent impedance of the armature. This apparent impedance or transient impedance is not constant. Its final value is the synchronous impedance, but its initial value is much less than this and is more nearly equal to the armature leakage impedance. It is, however, somewhat greater than the leakage impedance on account of the mutual inductance between the armature and field windings during the transient period.

When an alternator is short-circuited, the conditions are very complicated on account of the rapid increase in the armature reaction. Due to this armature reaction, which may be considered as produced by alternating currents in the armature windings superposed upon direct currents in those windings, there is a complicated mutual induction between the armature and field circuits which causes an alternating current to be induced in the field winding. In spite of these complications, equation (49*b*) may be used to predict, with a fair degree of accuracy, the maximum possible value that can be reached by the current in any phase during the transient period of a short-circuit. The conditions, which produce the maximum possible value of the instantaneous short-circuit current, are the same as those which produce the maximum transient term in equation (49*b*).

Under steady conditions of operation the armature reaction of a polyphase alternator under balanced load is sensibly con-

stant in magnitude and is fixed in direction with respect to the field axis. During the transient period of a short-circuit it is neither fixed in direction with respect to the field poles nor constant in magnitude. It may be considered to be produced by an alternating current in each phase superposed upon a direct current. Both of these components in each phase decrease rapidly in magnitude, the alternating current component approaching the final value of the short-circuit current as a limit while the direct-current component approaches zero.

In a *Y*-connected alternator, and probably in a Δ -connected one as well, the sum of the alternating components in the three phases is zero and the sum of the three direct-current components is also zero. If the alternator has non-salient poles, the alternating current components produce an armature reaction which is nearly fixed in direction with respect to the poles but which decreases rapidly in magnitude. The three direct-current components of the armature currents produce a reaction which is fixed with respect to the armature and which therefore sweeps by the poles at fundamental frequency, producing in them a variation in flux also of fundamental frequency. This variation in field flux produces an alternating voltage and therefore an alternating current of like frequency in the field winding. The fundamental variation in field flux combined with the rotation of the armature with respect to the field causes a second harmonic current in each armature winding. Although each of the second harmonic currents alone would produce a third harmonic in the field flux which would react to produce a fourth harmonic in the armature voltage, the resultant reaction on the field of the second harmonic currents in all three armature windings is zero. The reflection stops in a polyphase alternator with the fundamental in the field flux and the second harmonic in the armature currents. The statements just made regarding the frequency of the transient reactions in a polyphase alternator are only approximate. Actually the frequencies produced in the field flux and in the armature currents are not exactly of fundamental and twice fundamental frequency. A second harmonic will usually be found in the short-circuit currents of three-phase alternators during the transient period. The first harmonic or fundamental in the field will be large.

The resistance and reactance of the field winding of an alter-

nator are high compared with the resistance and reactance of the direct-current circuit which supplies the field current. The field may therefore be considered short-circuited so far as concerns the current induced in it by the armature reaction. It acts like the short-circuited secondary of a transformer for which the armature windings act as primary. The alternating current produced in the field windings by the direct-current components of the armature currents will tend to damp out the variation in the field flux produced by these currents. If it were not for this damping effect of the field current the voltage induced in the field winding would be very high. Anything that is added to the field circuit to prevent an alternating current in it will cause a dangerously high voltage to be induced in the field circuit during the transient period.

When short-circuit occurs, the sudden increase in the armature reaction which is produced by the alternating components of the armature currents causes a rapid increase in the direct current in the field by mutual induction. The field magnetomotive force must increase to balance the demagnetizing effect of this armature reaction. The effect is to tend to prevent any change in the field flux and to hold the armature voltage at the value it had at the instant short-circuit occurred. On account of this effect the armature reaction has very little influence on the apparent reactance of an alternator during the first few cycles of a short-circuit. The apparent reactance is substantially equal to the leakage reactance of the armature during this time. During the first few cycles of a short-circuit the effect in any phase is approximately the same as if a voltage equal to that induced in the armature just before short-circuit were impressed on an impedance equal to the leakage impedance of the armature, *i.e.*, equal to $\sqrt{r_e^2 + x_a^2}$, where r_e and x_a are respectively the effective armature resistance and the leakage reactance of the armature per phase. Since r_e is usually small compared with x_a , the maximum value of the short-circuit current is limited almost entirely by the leakage reactance of the armature. Equation (49b) shows that the maximum current, when the resistance is small compared with the reactance, is nearly equal to $\frac{2E_m}{x_a}$. It would have very nearly this value in any phase if the short-

circuit occurred at a point on the electromotive force wave for that phase which made $(\alpha - \theta) = \frac{\pi}{2}$, where θ is the angle whose tangent is equal to the ratio of the armature leakage reactance to the armature effective resistance.

If the ratio of the synchronous reactance to the leakage reactance of an alternator is 4 and the alternator be short-circuited at the point on the electromotive force wave of one phase which would produce maximum transient short-circuit current in that phase, the first maximum value of this transient short-circuit current would be $2 \times 4 = 8$ times the maximum value of the sustained short-circuit current. If the root-mean-square value of the sustained short-circuit current were $2\frac{1}{2}$ times the full-load root-mean-square current, the first maximum of the transient short-circuit current would be $8 \times 2\frac{1}{2} \times \sqrt{2} = 28$ times the root-mean-square value of the full-load current.

There are only two ways in which the transient short-circuit current of an alternator may be reduced, namely: by inserting reactance in series with each phase of the armature winding, and by putting reactance in the field circuit. The first is equivalent to increasing the slot or leakage reactance, while the second is equivalent to increasing the field reactance. The first makes the regulation poorer. The second does not affect the regulation but it cannot safely be used.

Putting reactance in the field circuit decreases the change in the field current that would otherwise be caused by the transient armature reaction. It is the momentary increase in the field current produced by the armature reaction of the alternating-current components of the short-circuit armature currents that tends to prevent the changes in flux which would reduce the induced voltages and diminish the short-circuit currents. Reactance in the field also reduces the alternating current induced in the field winding by the direct-current components of the short-circuit armature currents. It is this alternating current component in the field which, by its reaction on the armature, reduces the variation in the field flux of fundamental and higher frequencies, produced by the direct-current components of the armature currents, and thus prevents a dangerously high alter-

nating voltage being induced in the field winding during the transient period of a short-circuit.

The transient short-circuit current of large alternators is now limited in practice to a safe value by the use of air-core reactors placed in series with each phase of the alternator. Their effect

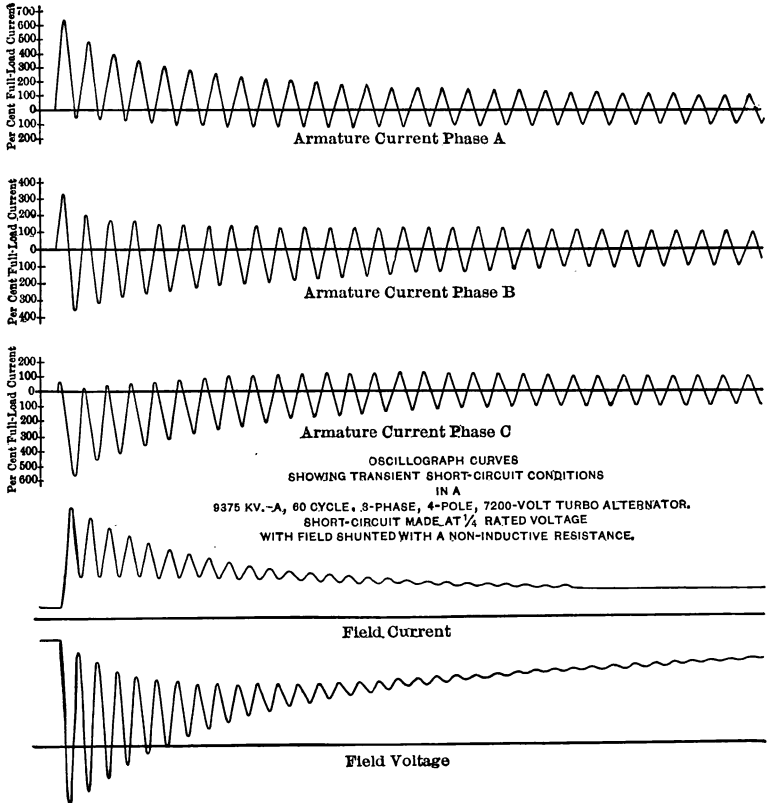

FIG. 63.

is equivalent to increasing the leakage reactance. High leakage reactance will reduce the transient short-circuit current of an alternator but high armature reaction will have relatively little effect. If anything, high armature reaction will tend to increase the transient short-circuit current of an alternator by increasing the mutual induction between the armature and

field windings. The transient short-circuit current is limited principally by armature leakage reactance and armature resistance. The sustained short-circuit current is limited chiefly by armature reaction but to some extent by the armature leakage reactance and resistance. Winding an alternator for high leakage reactance or using a reactor in series with each phase makes the regulation poor, but this is of minor importance as automatic voltage regulators are now almost universally used to maintain the voltage of alternators.

Fig. 63 shows oscillograms of the armature currents, field current, and field voltage of a 9375-kv-a., 3-phase, turbo-alternator, when short-circuited at $\frac{1}{4}$ rated voltage. During the short-circuit the field winding was shunted by a non-inductive resistance to protect it from injury from high voltage. For this reason the oscillograph curve of field current shown in Fig. 63 shows no rise in voltage across the field. Without this resistance there probably would have been considerable rise in voltage across the field. The scale is too small to show the second harmonics in the armature currents.

CHAPTER IX

CONDITIONS AND METHODS FOR MAKING HEATING TESTS OF ALTERNATORS WITHOUT APPLYING LOAD

Conditions for Making Heating Tests.—In order to determine the actual temperature rise in the different parts of an alternator, it is necessary to run the alternator under normal load conditions until steady temperatures have been attained. Such a test would consume a large amount of power and would be very expensive. Moreover, there are few if any manufacturing companies which have sufficient power available to run at full load generators as large as are now being built. To meet these conditions and to obviate the necessity for actually loading an alternator in order to determine its temperature rise under normal rated load, certain methods have been devised by means of which a heat run may be carried out without a large expenditure of power. None of these methods reproduce the conditions of actual load, but some reproduce them much more closely than others. The chief methods of making heating tests without actually applying load are:

(a) The zero-power-factor method.

(b) Operating the generator short-circuited with 25 per cent. over full-load current and measuring the temperature, then repeating the test with the generator on open circuit with 25 per cent. over rated voltage.

(c) Hobart and Punga method using alternate periods of open and short-circuit.

(d) Goldsmith method using direct current in the armature.

(e) Mordey method and a modification of it.

(a) *Zero-power-factor Method.*—The alternator, for this method of making a heat run, is operated at no load as an over-excited synchronous motor at rated voltage and frequency, with its field excitation adjusted so as to cause full-load current to exist in its armature. Under these conditions, the power factor

will be very low and little actual power will be required. It is necessary, however, in order to carry out this test, to have a power plant which has a kilovolt-ampere capacity at least equal to the rated kilovolt-ampere capacity of the alternator being tested.

The armature copper loss will be normal, but the field copper loss will be considerably too high. The core loss will also be somewhat too high on account of the over-excitation. To correct for the abnormal field heating, it is customary to multiply the field temperature rise obtained from the test by the ratio of the field loss under normal load conditions to the field loss during the test.

The zero-power-factor method of making a heat run is the method usually selected when sufficient kilovolt-ampere capacity is available. The test appears to be the most satisfactory of those mentioned.

A modification of the zero-power-factor method consists of operating the alternator to be tested on alternate periods of over- and under-excitation. By properly adjusting the relative lengths of the two periods, the average field copper loss can be made equal to its normal full-load value. Under these conditions the core loss will also be very nearly normal.

If two similar alternators are to be tested, both the heating and the losses may be obtained. One is driven as a generator and in turn drives the other as a synchronous motor. By properly adjusting the field excitation of both and the speed at which the first alternator is driven, the voltage, the current and the frequency of the two machines may be made equal to their normal full-load values. The field copper loss of one alternator will be larger, that of the other smaller, than under normal operating conditions. Correction for the field heating caused by this may be applied by the method already indicated. The power required to drive the machine which operates as a generator is the total losses of both alternators, exclusive of the field copper losses. One-half of this will be very nearly equal to the sum of the rotation and load losses of one alternator under the conditions of normal full load.

(b) Separate Open-circuit and Short-circuit Tests at Respectively 25 Per Cent. over Voltage and 25 Per Cent. over Full-load Current.

The alternator, for this method of testing, is run at rated frequency on open circuit at 25 per cent. over its rated voltage until the temperatures of its parts become constant. It is then allowed to cool down. When cool, the test is repeated with the alternator short-circuited and with its field excitation adjusted to give 25 per cent. over full-load current in its armature.

The 25 per cent. over full-load current is a very crude attempt to produce the same heating in the armature conductors and in the armature teeth as occurs under normal full-load operating conditions. When a generator is short-circuited, the impressed field must be less than normal and as a result the core loss will be smaller than under full-load conditions. In consequence of this, the temperature of the iron as a whole will be less than under normal load and the loss of heat from the conductors will be greater than it should be. Moreover, in certain generators under load, some parts of the iron may be hotter than the adjacent parts of the embedded armature conductors. Under this condition, heat will pass from the iron to the conductors. The factors which determine the temperature of the armature conductors and teeth of an alternator are altogether too complex to even be approximated by merely operating the alternator short-circuited at 25 per cent. over full-load current. Twenty-five per cent. over voltage is used in the open-circuit test to get approximately the same core temperature as at full load, but the conditions which determine core temperature under load are too complex to be reproduced in this way.

The temperatures obtained from the separate open-circuit and short-circuit tests are unsatisfactory at the best and can be considered only as guides for estimating the probable temperatures which would be reached under normal full-load conditions.

(c) *Hobart and Punga Method.*—In the Hobart and Punga method of making a heat test of an alternator, alternate periods of open-circuit and short-circuit are used. The lengths of these periods as well as the voltage and current employed are adjusted so that the average losses throughout a complete cycle, consisting of an open- and a short-circuit period, are equal to the losses under normal load conditions.

When an alternator is operated on short-circuit, the losses are: friction and windage, armature copper loss and core loss. On

open circuit, the losses are: core loss and friction and windage. The friction and windage losses need not be considered since they are nearly independent of the armature current and excitation.

Let the duration of a complete cycle consisting of an open-circuit and a short-circuit period be unity, and let x be the fraction of this period during which the alternator is short-circuited. Let I be the full-load armature current and let P_c be the normal full-load core loss.

If the armature current on short-circuit is $\frac{I}{\sqrt{x}}$, and on open circuit the field current is adjusted to cause a core loss equal to $\frac{P_c}{1-x}$, the average armature copper and core losses over the two periods will be the same as under load conditions. If I_o and I_s are the field currents for the periods of open-circuit and short-circuit, respectively, the average field loss will be

$$I_s^2 x + I_o^2 (1 - x) = I_{eq}^2.$$

I_{eq} may be called, for want of a better name, the equivalent field current. It is the constant field current which would produce the same heating as the average heating caused by I_s and I_o . In so far as the average armature copper loss and the average core loss are concerned, x may have any value, being limited only by the safe limits of short-circuit current and open-circuit excitation. I_{eq} depends upon the value chosen for x . By giving x the proper value, it should be possible to make the equivalent field current equal to the field current under load conditions. If this is done, the average losses will be the same as the losses under normal full-load conditions. The limits of possible short-circuit current and open-circuit voltage often make it impossible to use a value of x which will make the equivalent field excitation loss normal.

(d) *Goldsmith Method*.—For this method of making a heat run, the alternator is operated at normal full-load excitation in order that the iron loss caused by the field and the field copper loss shall be the same as those occurring at full load. The armature copper loss is supplied by sending a direct current through the armature equal to the full-load armature current.

The connections for supplying the direct current to the armature must be made in such a way as to prevent the high

alternating voltage, which will be induced in each phase of the armature, reaching the source from which the direct current is taken. This can be accomplished in several ways. If the alternator is three-phase Δ -connected, one corner of the delta may be opened and the direct current introduced at this point. If the alternator is Y -connected, it may be reconnected in delta and then treated like a Δ -connected machine. If the alternator is single-phase, the armature winding may be divided into two equal groups of coils which may be connected in opposition. Each of the two phases of a two-phase alternator may be treated like the one phase of a single-phase machine.

The objection to the Goldsmith method of making a heat run is that the ordinary load core losses are not present, and in their place there are other losses, produced mainly in the pole faces by the magnetic poles of the armature, which are caused by the direct current. These magnetic poles instead of being fixed with respect to the field poles, as they are when produced by the ordinary armature reaction of a polyphase alternator, revolve at synchronous speed.

(e) *Mordey Method and a Modification of It.*—In the Mordey method, the armature winding, or in the case of a polyphase alternator each phase of the armature winding, is divided into two unequal parts which are connected in series so that their electromotive forces oppose each other. The winding is then short-circuited through a suitable adjustable reactance coil.

The alternator is driven at its rated frequency with the field excitation adjusted so that the core loss is the same as under full-load conditions. Full-load current in the armature is obtained by adjusting the reactance coil in series with the armature winding.

Instead of dividing the armature into two unequal parts, the field may be similarly divided and connected so that two opposing but unequal electromotive forces are induced in each phase of the armature.

Neither of these two methods can be applied to modern alternators owing to the severe mechanical vibration which results from their use.

Behrend's modification of the Mordey method consists of dividing the field into two equal parts and varying the excita-

tions of these independently until full-load current exists in the armature which is short-circuited. This modification of the Mordey method does away to a considerable extent with the vibration and makes it possible to apply the method in many cases to modern slow-speed alternators.

CHAPTER X

CALCULATION OF OHMIC RESISTANCE, ARMATURE LEAKAGE REACTANCE, ARMATURE REACTION, AIR-GAP FLUX PER POLE, AVERAGE FLUX DENSITY IN THE AIR GAP AND AVERAGE APPARENT FLUX DENSITY IN THE ARMATURE TEETH FROM THE DIMENSIONS OF AN ALTERNATOR; CALCULATION OF LEAKAGE REACTANCE AND ARMATURE REACTION FROM AN OPEN-CIRCUIT SATURATION CURVE AND A SATURATION CURVE FOR FULL-LOAD CURRENT AT ZERO POWER FACTOR; CALCULATION OF EQUIVALENT LEAKAGE FLUX PER UNIT LENGTH OF EMBEDDED INDUCTOR AND EFFECTIVE RESISTANCE FROM TEST DATA; CALCULATION OF REGULATION, FIELD EXCITATION AND EFFICIENCY FOR FULL-LOAD KV-A. AT 0.8 POWER FACTOR BY THE A. I. E. E. METHOD

Alternator.—The calculations will be made for a 1000-kv-a., three-phase, 60-cycle, 32-pole, 225-rev. per min., 2400- (line) volt, Y-connected alternator.

The principal dimensions of this alternator are:

Number of slots.....	192
Size of slots.....	0.85 by 2.6 in.
Width of tooth at bottom.....	1.125 in.
Width of tooth at tip.....	1.04 in.
Diameter of armature at air gap.....	115.5 in.
Effective radial length of armature core.....	9½ in.
Mean axial depth of air gap.....	¾ in.
Armature coils lie in slots.....	1 and 5
Armature turns per phase.....	192
Inductors per slot.....	6
Each inductor consists of two bars in parallel; each bar.....	0.27 by 0.283 in.
Length of embedded armature inductor.....	9½ in.
Length of end connections per coil on one side of armature.....	16.6 in.
Number of poles.....	32
Number of turns per pole.....	65
Ratio of pole arc to pole pitch.....	0.72
Pole pitch measured on armature bore.....	11.4 in.
Friction and windage loss.....	10 kw.

The test characteristics of the alternator are shown in Fig. 64. Figs. 65 and 66 show, respectively, the arrangement of the armature winding and a slot. The cross-hatched rectangles in Fig. 66 represent the inductors. Each inductor consists of two bars in parallel as indicated.

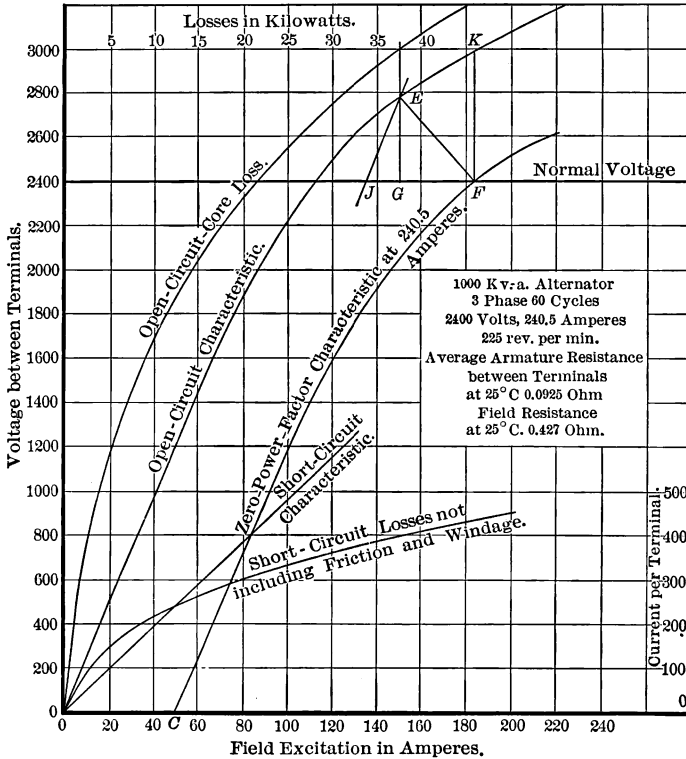

FIG. 64.

Ohmic Resistance of Armature from Dimensions of Alternator.—

Length of two inductors..... 18.25 in.
 Length of two end connections..... 33.2 in.

Length per turn..... 51.5 in.
 Length of conductor per phase = 51.5 × 192..... 9890 in.
 Cross-section of conductor = 0.54 × 0.283..... 0.153 sq. in.

The specific resistance of copper at 20°C. per centimeter cube is 1.72×10^{-6} ohms.

Armature resistance per phase at 20°C.

$$= \frac{9890 \times 2.54 \times 1.72 \times 10^{-6}}{0.153 \times (2.54)^2} = 0.0437 \text{ ohm.}$$

Armature resistance per phase at 25°C.

$$= 0.0437(1 + 5 \times 0.00385) = 0.0445 \text{ ohm.}$$

The measured resistance per phase was (see plot, Fig. 65)

$$\frac{0.0925}{2} = 0.0463 \text{ ohm per phase.}$$

Armature Leakage Reactance from Dimensions of Alternator.—Referring to equations (16), (17), (20), (21) and (24),

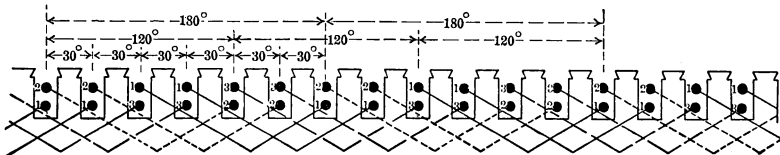

FIG. 65.

$$A = \frac{4\pi aZ^2}{w} \left\{ \frac{4d}{3} + (t + t') + 0.73w \log_{10} \frac{\pi w'' + w}{w} \right\}$$

$$= \frac{(4)(3.14)(9.13)(9)}{0.85} \left\{ 2.54 \left[1.267 + 0.55 \right. \right. \\ \left. \left. + 0.73(0.85) \log_{10} \frac{3.14(1.04) + 0.85}{0.85} \right] \right\}$$

$$= 3080 \times 2.24 = 6900$$

$$B = \frac{4\pi aZ^2}{w} \left\{ \frac{d}{2} + t' + 0.73w \log_{10} \frac{\pi w'' + w}{w} \right\}$$

$$= 3080[0.475 + 0.40 + 0.424]$$

$$= 4010$$

$$C = \frac{4\pi aZ^2}{w} \left\{ \frac{d}{3} + t' + 0.73w \log_{10} \frac{\pi w'' + w}{w} \right\}$$

$$= 3080[0.317 + 0.40 + 0.424]$$

$$= 3510$$

$$D = B = 4010$$

$$x_e = 2\pi f \left\{ 4.6lZ^2 \left(\log_{10} \frac{l}{d'} - 0.5 \right) \right\} 10^{-9}$$

$$= 2\pi f \left\{ 4.6 \times 33.2 \times 2.54 \times 9 \left(\log_{10} \frac{33.2}{1.08} - 0.5 \right) \right\} 10^{-9}$$

$$= 2\pi f \{ 3450 \} 10^{-9}$$

Since the alternator has a three-phase winding, the self- and mutual induction of each coil side are 60 degrees out of phase. Consider the coil of phase 1 which is in slots 3 and 7, Fig. 65. This has the back side of a coil in phase 3 with it in slot 3 and the front side of a coil in phase 2 with it in slot 7. The mutual induction produced on phase 1 in slot 3 by phase 3 is 60 degrees behind the self-induction of phase 1. The mutual induction produced on phase 1 in slot 7 by phase 2 is 60 degrees ahead of the self-induction of phase 1. Therefore, if s is the number of slots in series per phase, the leakage reactance of phase 1 is

$$\begin{aligned} x_a &= 2\pi fs \{ C + A + (D + B) \cos 60^\circ \} 10^{-9} + sx_e \\ &= 2\pi fs \{ 3510 + 6900 + (4010 + 4010) \frac{1}{2} \} 10^{-9} + 2\pi fs \{ 3450 \} 10^{-9} \\ &= 0.432 \text{ ohm.} \end{aligned}$$

Armature Reaction from Dimensions of Alternator.—The order in which the inductors of an armature winding are connected in series does not influence the voltage induced in the winding or the armature reaction it produces, provided the direction of current flow through the inductors is not changed. The voltage across the terminals of any phase is equal to the vector sum of the voltages induced in all the inductors of the phase and it is entirely independent of the order in which the component voltages are taken in making the vector summation.

The actual winding of the generator which is shown in Fig. 65 may be replaced, so far as voltage and armature reaction are concerned, by the equivalent winding shown in Fig. 67. To avoid confusion, the end connections of only one phase are indicated in this figure. The second winding differs from the first only in the order in which the end connections are made. The equivalent winding is a full-pitch winding containing two groups of coils which are slipped by each other by

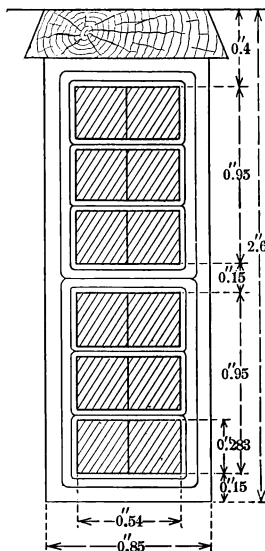

FIG. 66.

an angle which is equal to $180 - 120 = 60$ electrical degrees, that is, by an angle equal to the pitch deficiency. Each group of coils has a phase spread equal to the phase spread of the original winding. In general, any fractional-pitch winding may be replaced by two full-pitch windings which have a phase spread equal to the phase spread of the original winding and which are slipped by each other by an angle equal to the pitch deficiency. The voltages induced in the two windings are, consequently, out of phase by an angle equal to the pitch deficiency measured in degrees. For purposes of calculation it is often convenient to replace a fractional-pitch winding by its equivalent full-pitch winding.

The armature reaction of the 1000-kv-a. generator will be calculated from the equivalent winding shown in Fig. 67 by finding the reaction of each of the two groups of full-pitch coils and then adding these reactions vectorially. The reactions of the two groups of coils will, of course, be equal. Each group of the

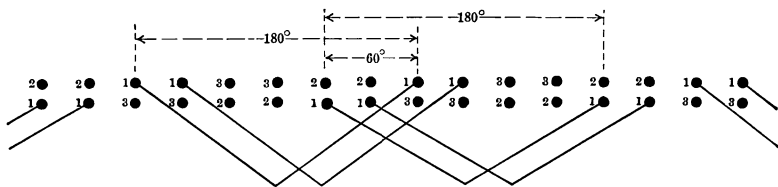

FIG. 67.

full-pitch coils will contain one-half the total number of series armature turns.

$$A = 0.707 \frac{NI_a k_b}{2p} \left\{ 2 \cos \frac{180 - \rho}{2} \right\} \text{ampere-turns per pole}$$

where N , I_a , k_b , p , and ρ are, respectively, the total number of armature turns in series, the phase current, the breadth factor, the number of poles and the coil pitch. The equivalent winding as well as the original winding has two slots per pole in each group of coils. From Table I, page 41, k_b is 0.966.

$$\begin{aligned} A &= 0.707 \frac{\left(\frac{192 \times 6}{2} \right) (240.5) (0.966)}{2 \times 32} 2 \cos 30^\circ \\ &= 2560 \text{ ampere-turns per pole.} \end{aligned}$$

Air-gap Flux per Pole, Average Flux Density in the Air Gap and Average Apparent Flux Density in the Armature Teeth at No Load for a Terminal Voltage of 2400 Volts, from Dimensions of the Alternator.—The equivalent winding given in Fig. 67 will be used. The harmonics in the air-gap flux will be neglected.

$$E = 4.44 \left\{ \frac{N}{2} f \varphi_m k_b 2 \cos 30^\circ \right\} 10^{-8}$$

where N is the total number of turns in series per phase. As before $\cos 30^\circ$ is

$$\begin{aligned} \varphi_m &= \frac{E 10^8}{4.44 \left\{ N f k_b \cos 30^\circ \right\}} \\ &= \frac{\frac{2400}{\sqrt{3}} 10^8}{4.44 \left\{ 192 \times 60 \times 0.966 \times \frac{\sqrt{3}}{2} \right\}} \\ &= 3,240,000 \text{ lines per pole.} \end{aligned}$$

The area of a pole face measured at the surface of the armature is

$$9\frac{1}{8} \times 11.4 \times 0.72 = 75.0 \text{ sq. in.}$$

The average flux density in the air gap is, therefore,

$$\frac{3,240,000}{75.0} = 43,200 \text{ lines per square inch.}$$

The flux density in the teeth will be found for the base of the teeth. All the flux which enters the armature core will be assumed to pass through the teeth at their bases. In reality some flux will pass into the armature core through the slots without entering the teeth, but the amount of flux entering in this way will be small, except when very high tooth densities are used. As a rule, there is little flux in the slots below half their depth measured from the armature surface (see Fig. 61 and page 125).

The average number of teeth under a pole is equal to the pole pitch measured at the armature surface multiplied by the ratio of pole arc to pole pitch and divided by the width of a tooth at its top plus the width of a slot.

This is

$$\frac{11.4 \times 0.72}{1.04 + 0.85} = 4.34 \text{ teeth.}$$

The average apparent flux per tooth at its base

$$= \frac{3,240,000}{4.34} = 746,000 \text{ lines.}$$

The average apparent flux density in a tooth at its base

$$= \frac{746,000}{9\frac{1}{8} \times 1.13} = 72,300 \text{ lines per square inch.}$$

Calculation of Leakage Reactance and Armature Reaction from the Open-circuit Saturation Curve and a Saturation Curve for Full-load Current at Zero Power Factor.—The open-circuit saturation curve and the saturation curve for full-load current at zero power factor are plotted in Fig. 64. The Potier triangle, FGE , is constructed by taking the point F on the zero-power-factor curve corresponding to the rated terminal voltage of the alternator and laying off the line FJ equal to and parallel to CO . The point E is located by drawing the line JE through the point J parallel to the lower part of the open-circuit characteristic. The armature leakage reactance is

$$\frac{\frac{1}{\sqrt{3}} EG}{I_a} = \frac{380}{\sqrt{3} \times 240.5} = 0.913 \text{ ohm.}$$

The armature reaction is

$$\begin{aligned} GF \times (\text{turns per pole}) &= 33 \times 65 \\ &= 2150 \text{ ampere-turns per pole.} \end{aligned}$$

Equivalent Leakage Flux per Ampere per Unit Length of Embedded Inductor.—According to equation (26), page 78, the leakage reactance is

$$x_a = 2\pi f l Z^2 \varphi_e s 10^{-8}$$

where φ_e is the equivalent leakage flux per ampere per unit length of embedded inductor and Z is the number of series inductors per slot. Since the 1000-kv-a. alternator has a winding having a

pitch of 120° , the leakage fluxes produced by the two coil sides in each slot are 60° out of phase. For this generator

$$x_a = 2\pi f l Z \left(\frac{Z}{2} \varphi_e + \frac{Z}{2} \varphi_e \cos 60 \right) s 10^{-8}$$

$$0.913 = 2(3.14)(60)(9\frac{1}{8}) \left(\frac{6^2}{2} \right) \varphi_e (1 + \frac{1}{2})(64) 10^{-8}$$

$$\varphi_e = 15.4 \text{ lines per inch of embedded inductor.}$$

Effective Resistance from Test Data.—The total short-circuit losses not including friction and windage are, from the plot, Fig. 64, 12.3 kw. at full-load current. The core loss due to the resultant field on short-circuit is approximately equal to the open-circuit core loss corresponding to a voltage $GE = 380$. This core loss is 1 kw. The effective resistance is, therefore,

$$r_e = \frac{(12.3 - 1)(1000)}{3(240.5)^2} = 0.0652 \text{ ohm per phase.}$$

Assuming that the temperature during the short-circuit run was 40°C ., the effective resistance at 75°C . is equal to the effective resistance at 40°C . minus the ohmic resistance at 40° plus the ohmic resistance at 75° . Therefore, the effective resistance at 75°C . is

$$0.0652 - 0.0463(1 + 15 \times 0.00385) + 0.0463(1 + 50 \times 0.00385) = 0.0714 \text{ ohm.}$$

Regulation, Field Current and Field Loss by the A. I. E. E. Method for Full Kv-a. Load at 0.8 Power Factor.—The synchronous reactance drop per phase is equal to the length of the line FK , Fig. 64, divided by the $\sqrt{3}$.

$$x_s = \frac{\frac{1}{\sqrt{3}} FK}{I_a} = \frac{580}{240\sqrt{3}} = 1.40 \text{ ohms.}$$

If E'_a is the open-circuit phase voltage, the open-circuit terminal voltage is

$$\begin{aligned} \sqrt{3}E'_a &= 2400 + \sqrt{3}(240.5)(0.8 - j0.6)(0.0714 + j1.40) \\ &= 2774 + j448 \\ &= 2810 \text{ volts.} \end{aligned}$$

$$\text{Regulation } \frac{2810 - 2400}{2400} 100 = 17.1 \text{ per cent.}$$

The field excitation corresponding to the voltage 2810 on the open-circuit characteristic is the excitation required for a load of 1000 kv-a. at 0.8 power factor and 2400 volts. This is 153 amp.

The field of this generator is built for 110 volts. The field loss including the loss in the field rheostat is, therefore,

$$153 \times 110 = 16,830 \text{ watts.}$$

Efficiency by the A. I. E. E. Method.—According to equation (48), page 131,

$$\text{Efficiency} = \frac{\sqrt{3}VI \cos \theta}{\sqrt{3}VI \cos \theta + P_c + 3I_a^2 r_e + P_{f+w} + I_f V_f}$$

where P_c and P_{f+w} are, respectively, the core loss and the friction and windage loss.

The core loss should correspond to a voltage which is

$$\begin{aligned} 2400 + \sqrt{3}(240.5) (0.8 - j0.6) (0.0714) &= 2424 + j18 \\ &= 2424 \text{ volts.} \end{aligned}$$

This core loss from Fig. 64 is

$$22,000 \text{ watts.}$$

The American Institute rules recommend taking the stray load losses equal to the input to the generator short-circuited minus the friction and windage and armature copper losses. These losses combined with the armature copper losses give the loss due to the armature effective resistance. They will be so combined in calculating the efficiency.

Efficiency =

$$\frac{1000 \times 1000 \times 0.8 \times 100}{1000 \times 1000 \times 0.8 + 22,000 + 3(240.5)^2 0.0714 + 10,000 + 153 \times 110} = 92.9 \text{ per cent.}$$

STATIC TRANSFORMERS

CHAPTER XI

TRANSFORMER; TYPES OF TRANSFORMERS; CORES; WINDINGS;
INSULATION; TERMINALS; COOLING; OIL; BREATHERS

Transformer.—A transformer consists essentially of a laminated iron core linked with two windings of insulated wire. Its action depends upon the mutual induction which takes place between these two windings. Power is supplied to one of them at a definite frequency and voltage and is taken from the other at the same frequency but generally at a different voltage. The ratio of the two voltages depends upon the relative number of turns in the two windings. The winding to which power is supplied is called the primary; the other, which delivers power to the receiving circuit, is called the secondary. Either will serve equally well as primary or as secondary. If the primary winding has more turns than the secondary winding, the voltage will be lowered and the transformer is called a step-down transformer. If the secondary winding has the greater number of turns, the voltage will be raised and the transformer is called a step-up transformer.

Types of Transformers.—There are two more or less distinct types of transformers which differ in the relative positions occupied by the windings and the iron core. These are the core and the shell types. In the core type the windings envelop a considerable part of the magnetic circuit, while in the shell type the magnetic circuit envelops a considerable portion of the windings. As a result of these differences, the core type of transformer, as compared with the shell type, has a core of small cross-section and long mean length and windings of a relatively great number of turns of small mean length. For a given output and voltage rating, the core type will contain less iron but more copper than the shell type. By proper design both types of transformers may be made to have essentially the same electrical characteristics, but when designed for approximately the same flux densi-

ties and current densities in the copper, the shell type of the two will have the larger iron loss and the smaller copper loss. The almost universal use during the last few years of silicon steel with its small iron loss for the cores of transformers has made design favor the shell type of transformer in the majority of cases. The shell type is the better for large transformers as it permits better bracing of the coils against displacements caused by short-circuits. Under normal conditions the stresses between the windings and between successive turns of transformers are low, but at times of short-circuit they may be very great. A modern transformer may give from 25 to 50 times its full-load current on short-circuit if full voltage is maintained on its primary.

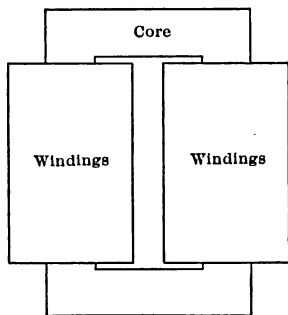

FIG. 68.

Under such conditions the stresses between the windings would be from $(25)^2 = 625$ to $(50)^2 = 2,500$, those at full load. The stresses on short-circuit are extremely important in large transformers. The core type works out best for very high voltages chiefly on account of greater space required for insulating the high- and low-tension coils of a shell-type transformer from one another. The space factor with the

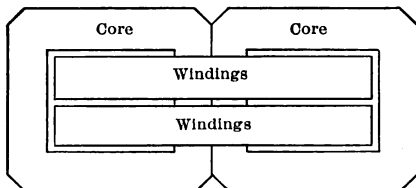

FIG. 69.

pan-cake type of coils used on shell transformers is poor and for very high-voltage transformers is often not over 0.3, while for the cylindrical coils used on the core type it may be, under similar conditions, as high as 0.4. Inherently the shell-type transformer has higher reactance than the core type of transformer on account of the type of coils used. Of the two types, the shell is the more expensive to repair.

The two types of transformers are shown in their simplest forms in Figs. 68 and 69.

Cores.—The laminated cores of transformers are built up of pieces of sheet steel stamped from steel plates. These stampings are insulated from one another by a thin coat of varnish. The thickness of the laminations will depend upon the kind of steel used and upon the periodicity for which the transformer is designed. With ordinary transformer steel and 60 cycles the thickness of the laminations may be as low as 0.014 in. thick, but with the newer so-called alloyed steel, *i.e.*, silicon steel, on account of its high specific resistance, it is not necessary to employ laminations which are thinner than 0.020 in.

The thickness of the core plates is determined by the allowable eddy-current losses. The thickness of the insulation be-

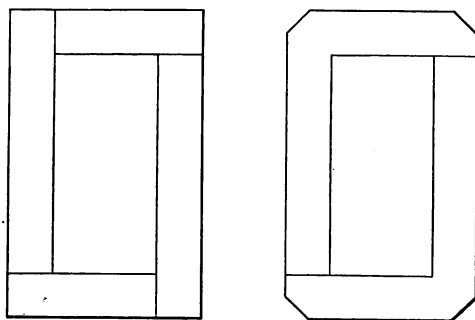

FIG. 70.

tween the core plates of a transformer does not depend upon the thickness of the plates. Consequently, the thinner the core plates, the lower will be the space factor, *i.e.*, the lower will be the ratio of the space occupied by iron to the gross space occupied by the core. Ordinary varnish insulation, such as is commonly used on the core plates of transformers, is usually about 0.001 in. thick. Table VII gives the percentage of the cross-section of a laminated core which is given up to insulation when the insulation is 0.001 in. thick.

No account is taken in Table VII of the diminution in thickness of the insulation after the core has been compressed and clamped. This diminution may amount to 1 or 2 per cent.

TABLE VII

Thickness of bare lamination in inches...	0.012	0.014	0.016	0.020
Thickness of insulation in inches.	0.001	0.001	0.001	0.001
Percentage of gross cross-section occupied by insulation.....	14.3	12.5	11.1	9.1

The laminations are built up into a core within the finished coils with the joints of the successive layers reversed so as to break them and make the reluctance of the core a minimum. The laminations are then firmly bolted together. Fig. 70 shows common forms of stampings for a core-type transformer.

Some manufacturers use butt joints in the magnetic circuit of large transformers to facilitate building up the core and removing coils in case of breakdown. When such joints are used it is

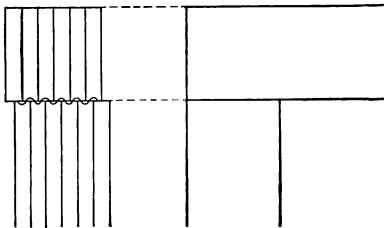

FIG. 71.

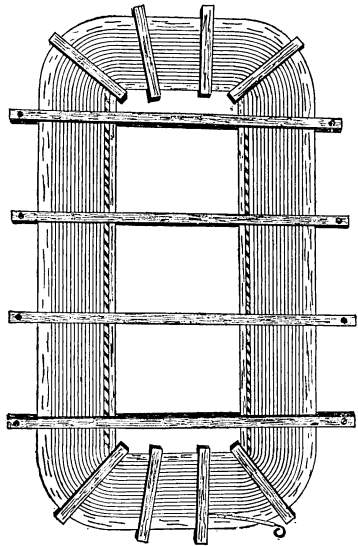

FIG. 72.

customary to insulate each joint with a layer of thin tough-paper about 0.005 in. thick to prevent loss due to eddy currents at the joints. Reference to Fig. 71 will show that unless the laminations of the two parts of the joints are exactly over one another, a path will be provided by which the eddy currents can pass from one lamination to the next across the joint as shown by the wavy line on the figure. This permits the eddy currents to flow in portions of the core at the joint much the same as if the core were not laminated. It is claimed by some that the loss in butt joints which are without insulating paper is no greater

than in ordinary lap joints. With lap joints, the greater part of the flux at the joints passes from one lamination to the next nearly perpendicularly to the plane of the laminations. At these points the planes of the paths of the eddy currents, therefore, will lie in the laminations. The lamination of the core will have no effect on these eddy currents.

Lap joints are equivalent to small air gaps. They will usually call for an increase in the magnetomotive force required for the core of about 35 ampere-turns per joint at ordinary flux densities. Butt joints must be figured as air gaps equal in length to the thickness of the paper insulation in them.

Windings.—The windings of all transformers of any appreciable size and voltage are subdivided to increase the insulation and to diminish the leakage of flux between the primary and secondary. Each winding is made up of several or many coils which are either flat pan-cake shaped, such as are commonly used on shell-type transformers, or cylindrical, such as are used on core-type transformers. These two shapes or types of coils are illustrated in Figs. 72 and 73 respectively.



FIG. 73.

The coils are of cotton-covered wire of either round or rectangular cross-section and are machine wound. After being formed, the coils are taped to hold them together and then thoroughly impregnated with insulating compound. Where proper insulation can be provided, wire of rectangular cross-section is desirable since it occupies less space for the same effective cross-section than round wire. The coils are sometimes formed of flat strip copper wound edgewise with strips of varnished paper, cambric or mica paper between the successive turns.

The primary and secondary windings of small core-type transformers are made in two sections, and one primary and one secondary section are placed on each of the two upright sides of the iron core. One winding is placed outside of the other to minimize the magnetic leakage.

Insulation.—The separate turns of the coils, as has been stated under windings, are insulated with cotton, cambric or mica paper.

To prevent breakdown between successive layers it is necessary, especially in high-voltage coils, to provide extra insulation in the form of fuller board or mica paper. When this is required, it is extended slightly beyond the ends of the windings to prevent creepage. It is usual to limit the voltage of a single coil to about

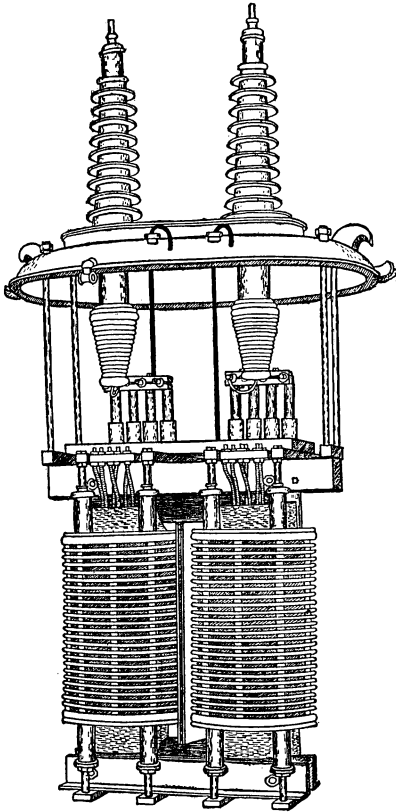

FIG. 74.

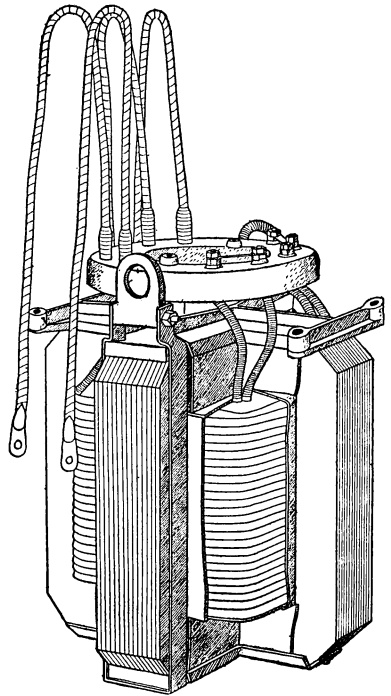

FIG. 75.

5000. When the voltage of a winding exceeds this, the winding should be subdivided into a number of coils with insulation between them. Special insulation is required between the high- and low-voltage coils and the core. Very high-voltage transformers, that is, for 40,000 volts and over, require insulation of the greatest dielectric strength between the coils and core. For

this purpose built-up mica and shields of press board are used. The different sections of the windings are held apart by wooden separators, and oil in the spaces left between the sections not only cools the coils but also provides the necessary insulation.

In order to prevent breakdown of the insulation due to surges, the end turns of large high-voltage transformers are given extra insulation. The high potential between the end turns which is caused by line surges is due to the distributed capacity between the high- and low-tension windings and the core and frame.

Fig. 74 shows a high-voltage core type of transformer without its case. The low-voltage windings are next the core. The high-voltage windings are outside of the others and are sectionalized for better insulation. They are insulated from the low-voltage windings by cylindrical barriers which are clearly shown in the figure.

Fig. 75 shows a small moderate-voltage shell-type transformer without its terminals and case.

Terminals.—The insulation of the very high-voltage terminals, *i.e.*, for 40,000 volts and over, is a difficult problem which has been solved by the use of two quite different types of terminals known as the oil-insulated terminal and the condenser terminal. The oil-insulated terminal consists of segments of porcelain or other moulded material built up about the conducting rod to form an enclosure for oil. The oil space is subdivided vertically by insulating cylinders to prevent lining up of particles in the oil, thus concentrating the dielectric stress and causing breakdown. The porcelain segments are shaped on the outside so as to form a series of petticoats to increase the creepage distance. The potential transformer shown in Fig. 112, page 226, has oil-insulated terminals. The condenser type of terminal is built up of alternate layers of tin-foil and paper treated with shellac or bakelite rolled hot onto the conducting rod. The purpose of tin-foil is to distribute the dielectric stress uniformly throughout the insulation. In order to accomplish this it is necessary to have the lengths of the successive layers of tin-foil and paper differ by equal amounts. This causes the two ends of the terminal to taper. The terminal is completed by the addition of a flat disc of insulating material at the top and an external insulating tube extending the length of the terminal. The space

between the tube or case and the terminal is filled with oil or insulating compound to prevent corona. A condenser terminal with and without cases is shown in Fig. 76. From left to right this figure shows the terminal, the terminal with its case for indoor service and the terminal with its case for outdoor service.

For moderate voltages porcelain bushings are used. To prevent moisture and water entering the transformer cases, the leads

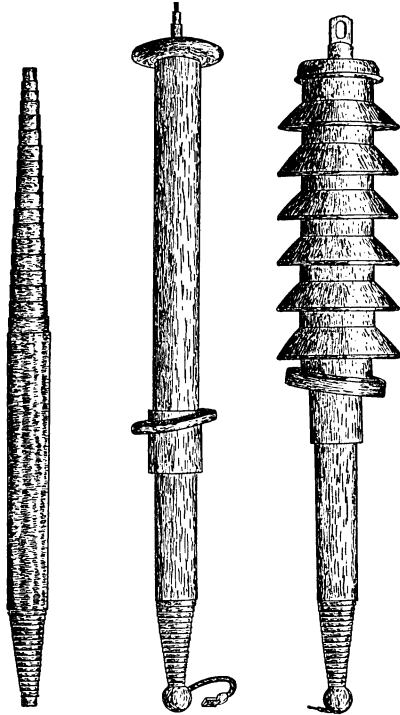

FIG. 76.

of transformers for not over a few thousand volts leave the containing cases under projecting ledges on each side near the top, the high- and low-voltage leads being placed on opposite sides.

Cooling.—Since the output of any piece of electrical apparatus is limited by the rise in temperature caused by its losses, one of the most important problems in design is to provide some satisfactory means of cooling. Since the losses in a transformer vary

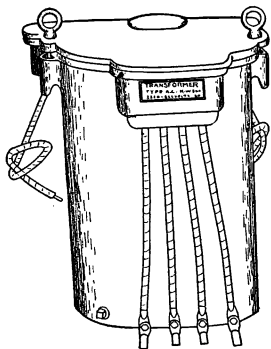

FIG. 77.

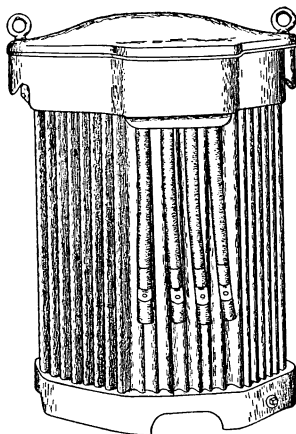

FIG. 78.

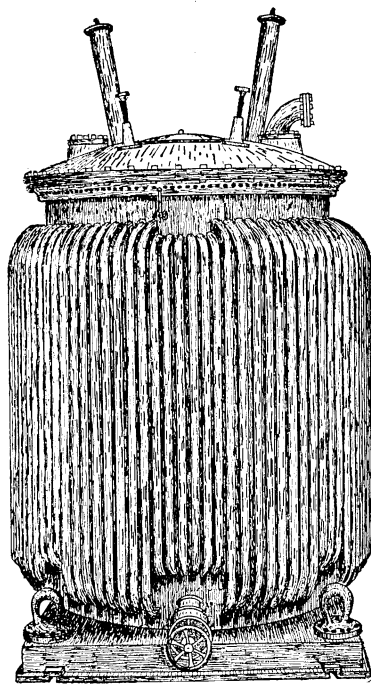

FIG. 79.

about as the volume while the amount of heat that can be dissipated depends upon the surface exposed, it will be seen that the problem of cooling a transformer becomes more difficult as its size is increased.

The coils of most transformers are placed in oil contained in cast-iron or sheet-steel tanks. To insure effective cooling, the coils and core are so arranged that the heated oil may rise readily to the top through ducts between the coils and between the coils

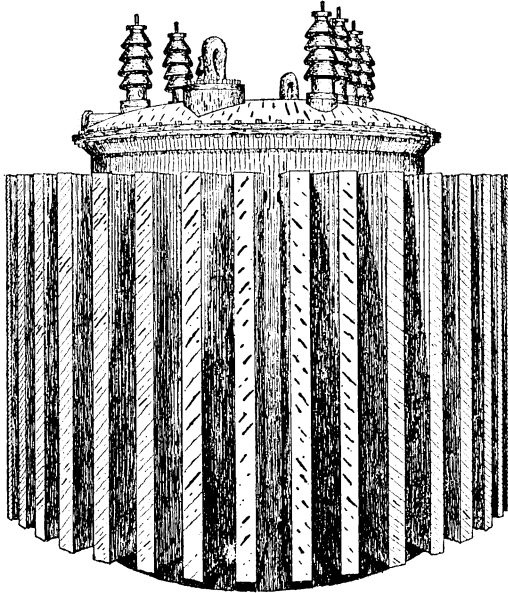

FIG. 80.

and the core. It will then pass down along the cooler walls of the transformer case.

As only about 1 watt can be radiated from each 150 sq. in. of dry surface of ordinary transformer cases with smooth sides for each degree Centigrade rise in temperature, special means for cooling have to be provided, except for the smallest transformers. Sufficient radiating surface can be obtained to keep transformers up to a few hundred kilowatts cool by corrugating the sides of the cases. Corrugating or ribbing the sides of the cases increases

the amount of heat radiated by about 50 per cent. When cooling water is available, the most common means of keeping large transformers cool is to circulate water through coils of pipe placed in the tops of the transformer cases in the oil above the windings. When this is done corrugated containing cases are not necessary. Transformers for low voltage, *i.e.*, not over a few thousand, may be air-cooled. In this case no oil is used, but air is circulated

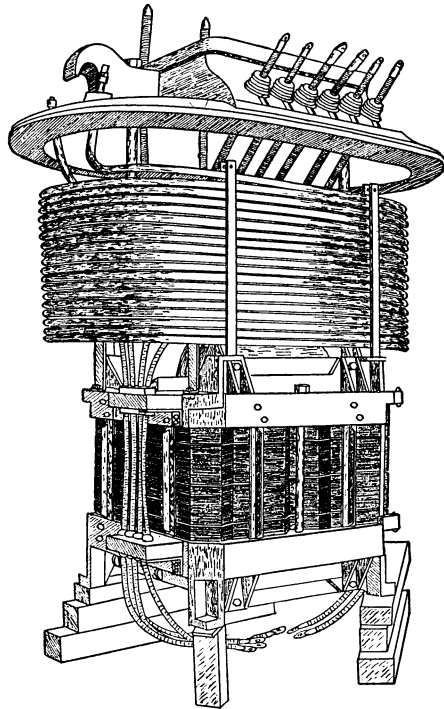

FIG. 81.

through the coils by means of a blower. In many cases, as, for example, in unattended substations, it is not possible to use artificial means of cooling. Under these conditions special cases with very large radiating surfaces are used. The required increase in surface may be obtained by welding vertical tubes to the cases at the top and bottom. In later types of cases for large self-cooled transformers radiating fins through which the

oil can circulate are attached to the cases. Self-cooled transformers may be made up to 3000 or even 5000 kw. by the use of such devices.

Typical transformer cases are illustrated in Figs. 77, 78, 79 and 80. These show respectively a case with smooth sides, a case with corrugated sides, a tubular case, and a radiator type of case. A transformer with a cooling coil for water is shown without its case in Fig. 81.

Oil.—The oil in an oil-cooled transformer not only carries the heat by convection from the windings and core to the transformer case and also to the cooling coils, provided they are used, but it also has the even more important function of insulation. The selection of a suitable oil is of the greatest importance. Transformer oil is obtained by fractional distillation of petroleum. It must be free from alkalis, sulphur and moisture. Moisture has a very marked effect on the dielectric strength of transformer oil. The presence of as small an amount as 1 part in 20,000 by volume decreases the puncturing voltage to nearly one-third its initial value. Minute particles mechanically suspended in the oil very greatly decrease the puncturing voltage by localizing the dielectric stresses in the oil. The methods for cleaning and removing moisture from oil may be found in any of the standard handbooks for electrical engineers.¹

The ordinary specifications for transformer oil are given in Table VIII.

TABLE VIII

	Medium	Light
Flash point, degrees C.....	180-190	130-140
Burning point, degrees C.....	205-215	140-150
Freezing point, degrees C below zero.....	10-15	15-20
Color.....	White	White
Specific gravity at 13.5°C.....	0.865-0.870	0.845-0.850
Viscosity at 40°C. (Saybolt test).....	100-110	40-50
Acid, alkali, sulphur, moisture.....	None	None

The medium oil is used for self-cooled transformers. For water-cooled transformers the lighter oil is employed. The dielectric strength of transformer oil, measured between brass

¹Standard Handbook for Electrical Engineers, McGraw-Hill Book Co.

spheres 0.5 in. in diameter and placed 0.15 in. apart, should not be less than 30,000 volts.

Breathers.—Since a very small amount of moisture causes a very great decrease in the puncturing voltage of transformer oil, it is necessary to take special precautions to prevent moisture from entering transformer cases. In small transformers this is done by making the cases air-tight by sealing in the leads where they pass through the cases with some compound such as asphaltum and by making the joints between the covers and cases air-tight by clamping or bolting them down with gaskets of felt or other material between them and the cases.

It is practically impossible to make the cases of large transformers air-tight. For this reason, it is customary to provide them with definite openings or vents through which the difference in pressure inside and outside the cases, caused by changes in temperature of the transformer or by changes in atmospheric conditions, may equalize. When provision is made for the equalization of the pressure, devices technically known as "breathers" are used to prevent moisture entering the cases through the vent. In its simplest form a "breather" is merely a chamber with baffle plates in it, connected to the top of the transformer by means of a small pipe. The baffles are arranged to effectively prevent water or snow entering the transformer when it is used out of doors or in an exposed place.

Unless the air in a transformer is dry, a sudden drop in the temperature of the surroundings may cool the air in the transformer below the dew point and cause the moisture to precipitate. This is not likely to occur unless the transformer is lightly loaded and in an exposed place. To prevent this precipitation, "breathers" with provision for drying the air which passes through them are used on transformers which are placed out of doors. Such "breathers" contain a considerable quantity of calcium chloride over which the air must pass before entering the transformer.

The size of transformers above which it is desirable to use "breathers" depends upon the conditions of service, but in general it is customary to install "breathers" on outdoor transformers of 500 kv-a. or over and above 22,000 volts.

CHAPTER XII

INDUCED VOLTAGE; TRANSFORMER ON OPEN CIRCUIT; REACTANCE COIL

Induced Voltage.—The voltage induced in any winding depends merely upon the number of turns in the winding and the rate of change of the flux through it. It makes no difference how the change in flux is produced. The expression for the voltage induced in a transformer is the same as the expression for the voltage induced in a generator. Both voltages are produced by the variation of the flux linked with a coil, the only difference being that in the case of a generator the variation in the quantity of flux linked with the coil is caused by a relative movement between the axis of the coil and the axis of a constant field, while in the case of a transformer the axis of the coil and the axis of the field are coincident and the change in the flux linked with the coil is produced by a variation in the strength of the field.

Let φ_m be the maximum value of the flux through a transformer coil and assume this flux varies according to the sine law.

$$\varphi = \varphi_m \sin \omega t$$

Then, if N_1 is the number of turns on the coil, the voltage induced in the coil at any instant by the flux φ is

$$\begin{aligned} e &= -N_1 \frac{d\varphi}{dt} \\ &= -\omega N_1 \varphi_m \cos \omega t \end{aligned}$$

Therefore, the maximum voltage is

$$\begin{aligned} e_m &= \omega N_1 \varphi_m \\ &= 2\pi f N_1 \varphi_m \end{aligned}$$

The effective or root-mean-square voltage in volts will be

$$\begin{aligned} E_1 &= \frac{2\pi f}{\sqrt{2}} N_1 \varphi_m 10^{-8} \\ &= 4.44 f N_1 \varphi_m 10^{-8} \end{aligned} \tag{50}$$

If the voltage is not a sine wave, expression (50) becomes

$$E_1 = 4(\text{form factor})fN_1\phi_m 10^{-8} \quad (51)$$

Transformer on Open Circuit.—When an alternating potential is impressed on an inductive circuit, the current will increase until the total voltage drop around the circuit is zero. Under this condition the total voltage drop due to induction plus, vectorially, the resistance drop in the circuit will be equal to the impressed voltage.

$$V = -E + Ir$$

V and E are, respectively, the impressed voltage and the total voltage induced in the circuit by the flux linking with it. The diagram of connections for such a circuit when it contains iron and its vector diagram are shown in Figs. 82 and 83 respectively. The conditions shown in these figures correspond exactly to those existing in a transformer with the secondary circuit open.

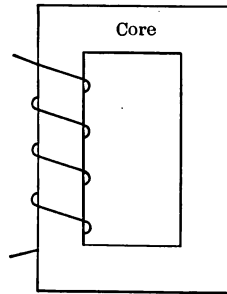

FIG. 82.

Referring to Fig. 83, E_1 is the voltage induced by the flux linking with the winding. To induce this voltage, a flux ϕ is required which will be 90 degrees ahead of the voltage. This flux will cause hysteresis and eddy-current losses in the iron core and for this reason the current I_1 producing it must have an energy component with respect to the voltage E_1 . I_1 may, therefore, be resolved into two components, one opposite in phase to E_1 and one in phase with the flux ϕ . The component I_ϕ which is in phase with the flux is the current which would be required to produce the flux if there were no core loss, and for this reason it is called the magnetizing component or simply the magnetizing current. The effect of the energy component of I_1 , that is of I_{h+e} , is to balance, so far as the production of flux is concerned, the demagnetizing effect of the hysteresis and the eddy currents in the core. In reality the actual currents, I_1 , I_ϕ and I_{h+e} , cannot be drawn as vectors, as will be shown later, since they are not sine waves even though the impressed voltage is a sine wave. These currents must, therefore, be considered

to be replaced, in Fig. 83, by their equivalent sine waves. The voltage V_1 impressed across the coil must balance E_1 and in addition must have a component equal to the resistance drop in the circuit. It will be equal to $-E_1$ plus the resistance drop, both taken in a vector sense. The current I_{h+c} depends upon the flux density in the core, upon the thickness of the laminations and upon the amount and quality of the iron. The magnetizing component I_ϕ of the current depends upon E_1 and the reluctance of the iron core. The power factor is $\cos \theta$. This will ordinarily depend mainly upon the ratio of I_{h+c} to I_ϕ .

Since it is desirable to make the no-load power factor of a transformer high, the reluctance of its core should be made low in order to make the magnetizing current small. The flux ϕ is

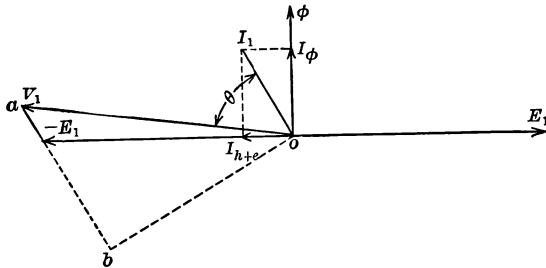

FIG. 83.

equal to the magnetizing force produced by the magnetizing current divided by the reluctance of the magnetic circuit or

$$\phi = \frac{0.4\pi N_1 I_\phi}{\frac{l'}{a'\mu'} + \frac{l''}{a''\mu''} + \frac{l'''}{a'''\mu'''} + \text{etc.}} \quad (52)$$

where the l 's, a 's, and μ 's are, respectively, the mean lengths, the cross-sections and the permeabilities of the different portions of the core. In case the core has a uniform cross-section and uniform permeability throughout, the denominator reduces to a single term.

Reactance Coil.—A reactance coil consists essentially of a winding on a laminated iron core which is designed so that the winding takes current at a low power factor. The magnetizing current should, therefore, be large. The conditions, as far as the

magnetic circuit are concerned, are just opposite to those required for a transformer.

If the winding has low resistance, $-E_1$ and V_1 will be nearly equal even for large variations in the current I_1 . Therefore, if V_1 is constant, E_1 and φ will be nearly constant, and the current I_{h+e} , which supplies the core losses, will also be nearly constant. The magnetizing current, I_φ , which depends upon the reluctance of the magnetic circuit, may be increased without appreciably affecting φ or I_{h+e} by merely introducing an air gap in the magnetic circuit. In this case the permeability for one of the reluctance terms in the denominator of equation (52) will become unity. By properly adjusting the air gap, the reactive component of the current I_1 may be made large compared with I_{h+e} . The power factor may, therefore, be varied by varying the length of the air gap. To keep the losses down and consequently make I_{h+e} small, it is necessary to design reactance coils to operate at low flux density. The resistance of the winding should also be made small as the resistance drop introduces an energy component in the voltage impressed across the coil and raises the power factor.

The line ba on the vector diagram shown in Fig. 83, page 166, is drawn parallel to the current I_1 and is the energy component of the voltage impressed on the circuit. It is, therefore, the apparent resistance drop through the winding. The line ob is the wattless component of the voltage drop in the circuit and represents the apparent reactance drop in the circuit.

Reactance coils with iron cores such as have just been described are often used in series with synchronous motors and synchronous converters to increase their stability. They are also used in connection with compound synchronous converters when automatic voltage control is desired.

Air-core reactances are an extremely important adjunct to the large modern central station to limit the current at times of accidental short-circuit of any part of the system. For this purpose they are placed in series with the part of the system to be protected. They may be placed in series with the generators, in series with the feeders or in the busbars, or in any two or all three of these places. Iron cores cannot be used in such current-limiting reactances for two reasons. First, the amount of iron which would be necessary to prevent saturation being far ex-

ceeded at times of short-circuit would make the coils prohibitively expensive, bulky and heavy. Moreover, the loss in the core would be appreciable at times of normal operation. Second, the losses in the iron core, *i.e.*, hysteresis and eddy current, would so retard the change of flux through the core during the initial rush

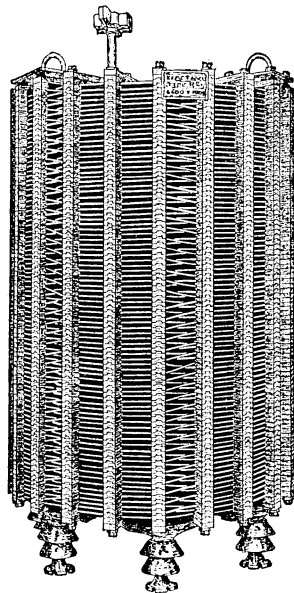

FIG. 84.

of current at times of short-circuit as to very largely reduce its usefulness. The initial rush of current from a generator at times of short-circuit may be ten times the sustained short-circuit current. It will reach this value in a fraction of a cycle but will be maintained only for a few cycles. A current-limiting reactance is shown in Fig. 84.

CHAPTER XIII

DETERMINATION OF THE SHAPE OF THE FLUX CURVE WHICH CORRESPONDS TO A GIVEN ELECTROMOTIVE-FORCE CURVE; DETERMINATION OF THE ELECTROMOTIVE-FORCE CURVE FROM THE FLUX CURVE; DETERMINATION OF THE MAGNETIZING CURRENT AND THE CURRENT SUPPLYING THE HYSTERESIS LOSS FROM THE HYSTERESIS CURVE AND THE CURVE OF INDUCED VOLTAGE; CURRENT RUSHES

Determination of the Shape of the Flux Curve which Corresponds to a Given Electromotive-force Curve.—If the wave shape of the voltage induced by the flux linking with the winding of a reactance coil or with the primary winding of a transformer is known, the shape of the flux curve corresponding to this may be found.

In the case of a reactance coil, it has already been shown that the impressed voltage is very nearly equal to the voltage induced by the flux. The impressed and induced voltages of a transformer of ordinary design are also very nearly equal, especially at no load. At no load, a transformer is exactly the same as a reactance coil which has a very good magnetic circuit. A good magnetic circuit is necessary since it is desirable to make the magnetizing current of a transformer as small as possible, since its presence increases both the primary copper loss and lowers the power factor. In determining the shape of the flux curve of a transformer it is sufficiently accurate to assume that the induced and impressed voltages of the primary winding are equal and opposite at every instant.

The voltage induced in a transformer is always equal to the negative rate of change of flux through the winding multiplied by the number of turns contained in the winding. If e is the

instantaneous value of the voltage and N_1 and φ are, respectively, the number of turns and the flux through the winding,

$$e = -N_1 \frac{d\varphi}{dt}$$

$$d\varphi = -\frac{1}{N_1} e dt$$

$$\varphi = -\frac{1}{N_1} \int_{t \text{ for } \varphi=0}^{t \text{ for } \varphi=\varphi'} e dt$$

The integral represents the area under the electromotive-force curve between an ordinate drawn through the value of t at which the flux is zero and an ordinate through the value of t at which the flux is desired. When φ is a maximum, $\frac{d\varphi}{dt}$ is zero. Therefore, the maximum value of the flux, either positive or negative, will

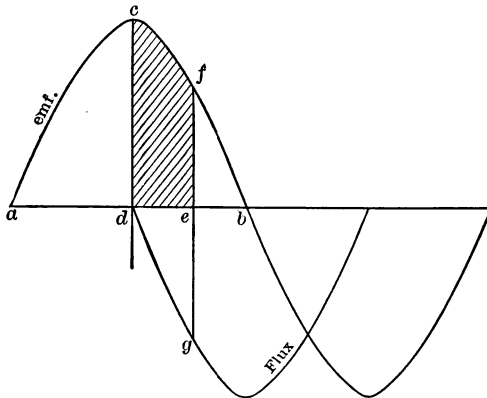

FIG. 85.

occur when the electromotive force is zero. Since between points of zero flux and the points of maximum flux on either side equal quantities of flux must be added and subtracted from the winding, it follows that ordinates drawn through the zero points of the flux curve must divide the areas enclosed by the positive and the negative loops of the electromotive-force curve into two equal parts.

Let $acfb$, Fig. 85, be the curve of the voltage induced in a transformer, and let the ordinate dc divide the area under the positive loop of this curve into two equal parts. The point d will then be one of the zero points of the flux curve.

The ordinate eg of the flux curve at the point e is negative and is equal to $\frac{1}{N_1}$ times the area enclosed by the electromotive-force curve between ordinates drawn through d and e . This area is shown cross-hatched. The other points on the flux curve may be found in a similar way.

The maximum points of the flux curve will obviously lie on the ordinates drawn through the points of zero electromotive force. The flux and electromotive-force curves will, therefore, be 90 degrees apart and the electromotive-force curve will lag with respect to the curve of flux.

The wave forms of the electromotive force and of the flux will not be the same except when the electromotive force is sinusoidal. This can be shown very easily by expressing the electromotive force as a Fourier series. Let the induced electromotive force be given by the following series:

$$e = E_1 \sin \omega t + E_3 \sin 3\omega t + E_5 \sin 5\omega t + \text{etc.}$$

The flux corresponding to this will be

$$\begin{aligned} \varphi &= -\frac{1}{N_1} \int edt = \frac{1}{N_1 \omega} [E_1 \cos \omega t + \frac{1}{3} E_3 \cos 3\omega t \\ &\qquad\qquad\qquad + \frac{1}{5} E_5 \cos 5\omega t + \text{etc.}] \\ &= \frac{1}{N_1 \omega} [E_1 \sin (\omega t + \frac{\pi}{2}) + \frac{1}{3} E_3 \sin (3\omega t + \frac{\pi}{2}) \\ &\qquad\qquad\qquad + \frac{1}{5} E_5 \sin (5\omega t + \frac{\pi}{2}) + \text{etc.}] \end{aligned}$$

If the electromotive force is sinusoidal, all of the terms above the first in the expressions for the voltage and the flux drop out leaving both waves sinusoidal. For any other wave form, any of the terms above the first may be present. Under this condition, the electromotive-force and flux waves will contain the same harmonics in the same phase relation with respect to each other, but their relative amplitudes will be different. The two waves will, therefore, be of different form. With respect to the fundamental, the third harmonic in the flux wave will be only one-third as great, the fifth only one-fifth as great, the seventh only one-seventh as great, etc., as the corresponding harmonics in the electromotive-force wave.

A peaked electromotive-force wave contains a third harmonic

which has its maximum value approximately coincident with the maximum of the fundamental and in phase with it as is shown in Fig. 86.

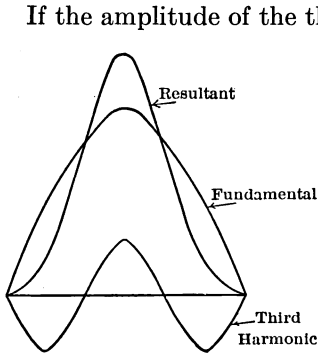

FIG. 86.

If the amplitude of the third harmonic in the flux wave is only one-third as great with respect to the fundamental as it is in the electromotive-force wave, the flux wave corresponding to the peaked electromotive-force wave shown in Fig. 86 will be flatter than that wave. In a flat electromotive-force wave the third harmonic would be in opposite phase to that shown in Fig. 86. In this case the diminution of the third harmonic in the flux wave would make the flux

wave less flat than the electromotive-force wave. In general, a flat electromotive-force wave will give rise to a flux wave which is less flat and, *vice versa*, a peaked electromotive-force wave will give rise to a flux wave which is less peaked.

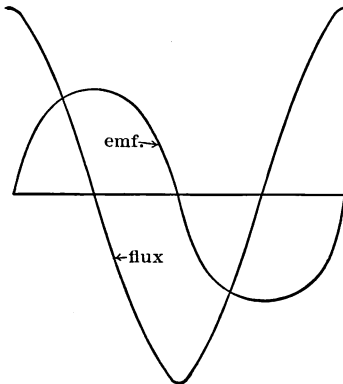

FIG. 87.

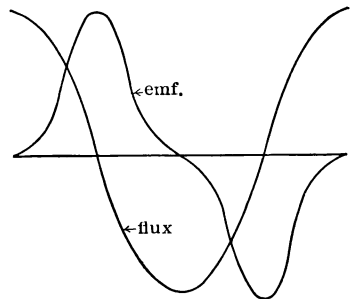

FIG. 88.

Figs. 87 and 88 show, respectively, flat and peaked electromotive-force waves of approximately the same root-mean-square value together with the corresponding flux waves.

Scale of Flux.—The flux is equal to $\frac{1}{N_1}$ times the area enclosed

by the electromotive-force curve between the ordinate which divides either loop of the curve into two equal areas and an ordinate drawn through the point at which the flux is desired. To get the numerical value of the flux, this area expressed in square inches must be multiplied by $\frac{1}{N_1}$, by the scale of the electromotive force in abvolts to the inch, and by the scale of time in seconds to the inch.

Determination of the Electromotive-force Curve from the Flux Curve.—The electromotiveforce induced in a coil is

$$e = -N_1 \frac{d\phi}{dt}$$

It is proportional to the rate of change of flux. Therefore, if the flux curve is plotted with flux as ordinates and time as abscissæ,

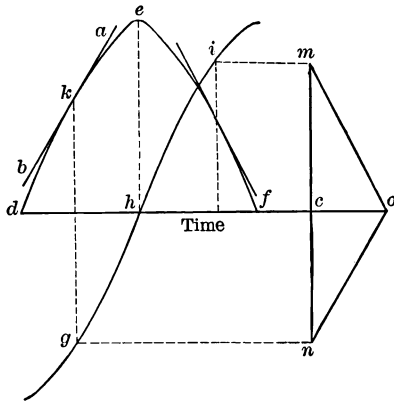

FIG. 89.

the slope of a line drawn tangent to the curve at any point will be proportional to the electromotive force at that point.

The electromotive-force curve corresponding to any flux curve may be obtained graphically by the construction shown in Fig. 89.

The flux curve is *def* and *ghi* is a portion of the corresponding electromotive-force curve. Any point such as *g* on the electromotive-force curve is obtained in the following manner: Draw a tangent *ab* at the point *k* of the flux curve. Select any point as,

for example, o at the right of the diagram and draw a vertical line mn at a distance oc to the left of this point. From the point o draw a line parallel to the tangent ab , and from where this line intersects mn draw a horizontal line gn . The point of intersection, g , of gn with a vertical dropped from k will be the point on the electromotive-force curve which corresponds to the point k on the flux curve.

If oc is to scale 1 second, cn measured to the scale of flux and multiplied by N_1 will be the voltage in abvolts. It will always be necessary to make the distance oc less than 1 second. In case it should be made $\frac{1}{100}$ of a second, cn must be multiplied by 100.

Determination of the Magnetizing Current and Current Supplying the Hysteresis Loss from the Hysteresis Curve and the Curve of Induced Voltage.—In order to determine the magnetiz-

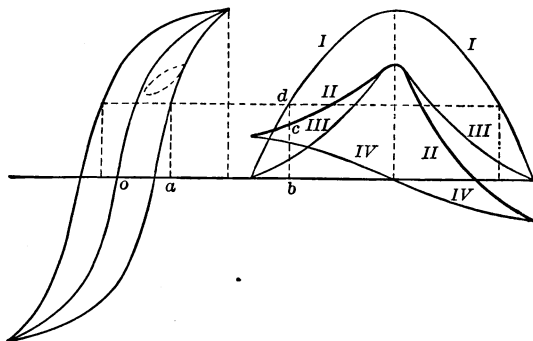

FIG. 90.

ing and hysteresis currents, it is first necessary to find the flux curve from the curve of impressed voltage by the method already described. It is then necessary to obtain, by measurement, the hysteresis loop for the iron core and to plot this with total fluxes as ordinates and currents as abscissæ. The maximum value of the flux density for the hysteresis loop and for the flux curve of the transformer or reactance coil must be the same. These two curves are plotted in Fig. 90.

Curves I, II, III and IV are, respectively, the curves of flux, the combined magnetizing and hysteresis currents, the magnetizing current and the hysteresis current.

The curve of combined magnetizing and hysteresis current, *i.e.*, Curve II, is obtained from the hysteresis loop and the flux curve in the following manner.

For any point such as *d* on the rising part of the flux curve, a current *oa* will be required. The current *oa* is laid off on *bd* giving a point *c* on the curve of the exciting current. The other points on this curve are obtained in a similar manner.

If $\frac{d\phi}{dt}$ changes sign between the maximum points of positive and negative flux, this construction does not hold, since the hysteresis loop would contain a small loop shown dotted in Fig. 90. The area of this small loop would represent an additional energy loss. If, however, the complete loop, *i.e.*, the full line plus the dotted portion of the hysteresis curve, were used, the correct result would be obtained.

The wave form of the so-called magnetizing or reactive component of the exciting current may be obtained in a similar manner by making use of the magnetization curve for the iron core. If there were no hysteresis losses the hysteresis curve would contract into a single line which would be the magnetization curve for the core. Both this line and the hysteresis curve for the core will be slightly different from the corresponding curves for the iron of which the core is built on account of the extra ampere-turns required to overcome the reluctance introduced into the magnetic circuit by any joints or air gap that may be present.

Subtracting the ordinates of curve III from those of curve II gives curve IV which is the curve of the component current required to supply the hysteresis loss. This last curve leads and is in quadrature with the flux curve, *i.e.*, with curve I. The flux curve is 90 degrees ahead of the curve of induced voltage—not shown—and, therefore, 90 degrees behind the curve of $-E_1$, that is, 90 degrees behind the component of the impressed voltage which is required to balance the voltage induced by the flux. The component current which supplies the hysteresis loss is, therefore, in time phase with $-E_1$. This is the phase relation which was used on the vector diagram of the reactance coil.

The component current which is required on account of the eddy-current loss will be of the same wave shape as $-E_1$ and

in time phase with it, provided the local fluxes set up by the eddy currents can be neglected as is done on page 201.

The magnetomotive force which is due to the component current supplying the eddy-current loss is just balanced by the equal and opposite magnetomotive force caused by the eddy currents. These two currents act like the primary and secondary currents of a transformer.

The component of the current taken by a reactance coil or of the no-load current of a transformer which is in quadrature with the induced voltage has been called the magnetizing current. This, however, is not the real current causing the flux. The current causing the flux is that shown by Curve II on Fig. 90 plus the current required to supply the eddy-current loss. The current which has been called the magnetizing current is the current which would be required to produce the flux if there were neither hysteresis nor eddy-current losses. The component currents I_h and I_e are required to supply the losses due to the hysteresis and eddy currents in the core, and it is due to those two components that the current required to produce the flux in a transformer or reactance coil leads the flux by a small angle which is known as the angle of core-loss advance. (See Fig. 83, page 166.)

It should be clear from Fig. 90 that the wave form of the current producing the flux in a reactance coil or in a transformer will be different from the wave form of the flux. If the flux follows a sine curve, the current causing it will not be sinusoidal but will contain harmonics among which the third will be large unless the magnetization curve of the core is nearly a straight line as it would be if the core contained a large air gap. The magnetic circuit of an ordinary transformer never contains an air gap. The magnetizing current for such a magnetic circuit, therefore, will contain a large third harmonic. If the component currents taken by a reactance coil or by a transformer at no load contain harmonics, they cannot be combined correctly as vectors as was done in Fig. 83. Fig. 83 must, therefore, either be considered as an approximation or, as was previously stated, the currents on this figure must be the equivalent sine values.

Current Rushes.—When a transformer is connected to a circuit, the current taken by it will not immediately assume its

final wave form and magnitude. The initial rush of current as well as the number of cycles passed through before the current wave assumes the final form will depend upon the part of the voltage wave at which the circuit is closed and upon the residual magnetism in the iron core and its direction with respect to the instantaneous value of the initial magnetomotive force. Under certain conditions, the current at the instant the circuit is closed may be several times the full-load current of the transformer. The current rush really depends upon the apparent instantaneous reactance of the circuit at the instant of switching in.

When a transformer is disconnected from the mains, the exciting current becomes zero but the flux does not necessarily drop to zero. If φ_r is the value of the remanent magnetism for the hysteresis cycle on which the core of the transformer is operating, the flux remaining in the core when the circuit is opened may have any value

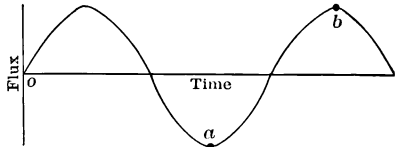

FIG. 91.

between $+\varphi_r$ and $-\varphi_r$ depending upon the particular point of the hysteresis loop at which the circuit is broken. If the transformer remains unexcited, this remanent magnetism will gradually decrease and approach zero.

Suppose the maximum flux in the core under steady conditions of operation is φ_m . Starting at the point of maximum negative flux, the flux under such conditions must change by an amount equal to $2\varphi_m$ or from a to b , Fig. 91, in a half cycle in order to develop the required induced electromotive force, but the maximum flux reached is only φ_m .

Suppose the transformer has no residual flux and is connected to the line at a point on the electromotive-force wave corresponding to the flux a , Fig. 91, *i.e.*, corresponding to a flux $-\varphi_m$ under steady conditions. Neglecting the effect of the resistance drop, the flux must still change by an amount equal to $2\varphi_m$ during the next half cycle to generate the required electromotive force, but the maximum value reached during this half cycle is now $+2\varphi_m$ since the flux started at zero instead of $-\varphi_m$. If the residual magnetism in the core at the instant of closing the circuit had been $\pm\varphi_r$ instead of zero, the maximum flux would have reached

a value $2\varphi_m \pm \varphi_r$. The maximum value of the current taken by the transformer during the first half cycle will correspond to a flux density, $2\varphi_m \pm \varphi_r$, which may be far above the saturation point for the iron core. The current rush will be greatest when φ_r is positive under the conditions assumed.

The transient condition as a rule will exist for only a few cycles. If the conditions are as assumed, the flux in the transformer may be either entirely positive or negative without reversal during the first cycle or even during several cycles. The exciting current corresponding to this condition is shown in Fig. 92.

The initial exciting current will be a minimum and less than normal when the circuit is closed at the point of the electromotive-force wave corresponding to zero flux under steady conditions and

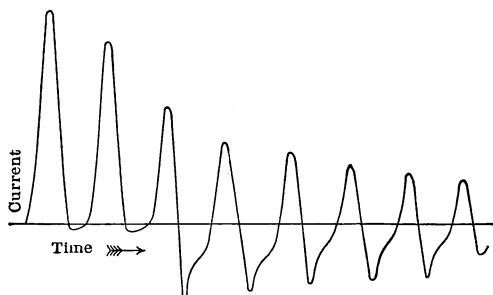

FIG. 92.

with the residual magnetism opposite in sign to the sign the flux should have during the next quarter cycle under steady conditions.

The current rush when transformers are connected in circuit will be greater for 25-cycle transformers than for transformers designed for 60 cycles on account of the higher flux densities which may be used for a given core loss at the lower frequency.

The total voltage, E_1 , Fig. 83, page 166, which has to be induced by the flux is limited by the resistance drop. If it was not for this drop, the exciting current on connecting a transformer to a line might reach, under the worst conditions, several hundred times its normal value. In low-frequency transformers it may easily reach in practice several times the normal full-load current.

CHAPTER XIV

FLUXES CONCERNED IN THE OPERATION OF A TRANSFORMER AND NO-LOAD VECTOR DIAGRAM; RATIO OF TRANSFORMATION; REACTION OF SECONDARY CURRENT; REDUCTION FACTORS; RELATIVE VALUES OF RESISTANCES; RELATIVE VALUES OF LEAKAGE REACTANCES; CALCULATION OF LEAKAGE REACTANCE; LOAD VECTOR DIAGRAM; ANALYSIS OF VECTOR DIAGRAM; SOLUTION OF VECTOR DIAGRAM AND CALCULATION OF REGULATION

Fluxes Concerned in the Operation of a Transformer and No-load Vector Diagram.—Due to the impossibility of having the primary and secondary windings of a transformer occupy exactly the same position on the iron core, there will be a certain amount of magnetic leakage between them. All of the flux which links with the primary winding will not link with the secondary winding and, *vice versa*, all of the flux which links with the secondary winding will not link with the primary winding. For this reason it is convenient, when considering a transformer under load conditions, to divide the flux into three component fluxes, namely, the mutual flux and the primary and the secondary leakage fluxes.

The primary leakage flux is that part of the total primary flux which does not link with the secondary winding and, similarly, the secondary leakage flux is that part of the total secondary flux which does not link with the primary winding. The mutual flux is that part of the total primary or secondary flux which is common to or links with both windings. If the fluxes in the primary and the secondary windings are to be divided into two components, the voltages induced in the two windings may also be divided into two components corresponding to the two component fluxes.

The leakage fluxes of the primary and secondary windings of a transformer are very nearly proportional to the currents in the windings. Therefore, the component voltages produced by these

fluxes will also be proportional to the currents. Since the voltages produced by the two leakage fluxes are proportional to the currents causing the fluxes, the leakage fluxes may be replaced, so far as their effects are concerned, by two constant reactances.

That the leakage flux of a transformer should be nearly proportional to the current can be seen from what follows: consider a simple case where the primary and secondary coils of a core-type transformer are on opposite sides of the iron core. Refer to Fig. 93.

At no load the magnetic potential between *A* and *B* produced by the primary coil is only that necessary to force the flux through the iron circuit *ACB*. When the secondary circuit is loaded, the magnetic potential between *A* and *B* produced by the primary winding must not only overcome the reluctance of the iron path *ACB*, but it must in addition balance the opposing magnetomotive force caused by the current in the secondary winding. Since the increase in the magnetomotive force between *A* and *B* is proportional to

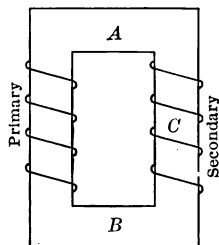

FIG. 93.

the secondary current, the leakage between *A* and *B* should be very nearly proportional to the load current carried by the transformer.

In what follows, the voltages which are induced in the primary and secondary windings by the mutual flux will be called the induced voltages and the voltages induced by the leakage fluxes will be replaced by a primary and a secondary leakage-reactance drop.

The leakage flux of an ordinary transformer is small and is also largely in air. Its effect on the apparent resistance will, therefore, be small. For this reason, the effective resistances of a transformer may be replaced by the ohmic resistances without introducing any appreciable error.

The following notation will be used:

N_1 = Turns in primary winding.

N_2 = Turns in secondary winding.

a = Ratio of transformation. This ratio will be expressed so as to be greater than unity, *i.e.*, 10 not 0.1.

- V_1 = Primary impressed or terminal voltage.
- V_2 = Secondary terminal voltage.
- E_1 = Voltage induced in the primary by the mutual flux.
- E_2 = Voltage induced in the secondary by the mutual flux.
- I_1 = Total primary current.
- I_2 = Secondary current.
- I_ϕ = Magnetizing component of the primary current.
- I_{h+e} = Component of the primary current supplying the core loss.
- $I_n = I_\phi + I_{h+e}$ (vectorially). This is the exciting current.
- I'_1 = Load component of the primary current, *i.e.*, the component caused by the load on the secondary.
- r_1 = Primary resistance.
- r_2 = Secondary resistance.
- x_1 = Primary leakage reactance.
- x_2 = Secondary leakage reactance.

Fig. 83, page 166, is the vector diagram of a reactance coil or of a transformer with the secondary circuit open. In the

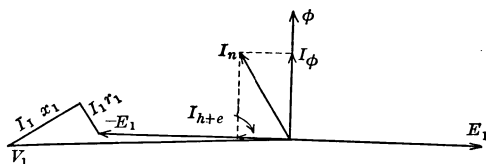

FIG. 94.

case of a transformer the magnetic circuit, as is stated on page 166, will be made as good as possible in order to make the magnetizing component of the current small. The resistance and leakage reactance will also be made small. On the diagram given in Fig. 83, ϕ is the total flux linking with the winding and E_1 is the voltage induced by this flux. In the case of the transformer, the total flux linked with the primary winding is to be divided into a mutual flux and a leakage flux and the effect of the leakage flux is to be replaced by a reactance. This leakage flux will be in phase with the total primary current, and the reactance voltage drop, which, in effect, replaces it, will lead the current by 90 degrees.

Fig. 94 gives the vector diagram of a transformer with the

secondary circuit open and with the total primary flux replaced by the mutual flux and a leakage reactance.

Referring to Fig. 94, φ is the mutual flux and I_φ is the magnetizing component of the primary current producing this flux. I_{h+c} is the component of the current supplying the core loss due to the mutual flux. I_n , the exciting current, is equal to the primary current I_1 at no load. E_1 is the voltage induced in the primary winding by φ . I_1x_1 and I_1r_1 are the leakage reactance and resistance drops respectively. I_1x_1 is drawn 90 degrees ahead of the current because it is the voltage required to balance the voltage induced by the leakage flux. The vector sum of $-E_1$ and I_1x_1 corresponds to what is marked $-E_1$ in Fig. 83 and is the voltage which must be impressed across the primary winding to balance the voltage induced in that winding by the total primary flux, *i.e.*, by the mutual flux plus the primary leakage flux.

The voltage impressed across the primary winding of a transformer is

$$V_1 = -E_1 + I_1(r_1 + jx_1) \quad (53)$$

In a properly designed transformer, the resistance and leakage reactance are small. The drop in voltage in the primary due to these will be small, especially at no load, when compared with the impressed voltage. Therefore, $-E_1$ and V_1 will be very nearly equal. They will seldom differ by more than 1 or 2 per cent. at full load and at no load they will not differ by more than a small fraction of 1 per cent. Therefore, as an approximation,

$$V_1 = -E_1 = 4.44fN_1\varphi_m 10^{-8} \quad (54)$$

It will be seen from equation (54) that the mutual flux in a transformer is determined by the frequency, the number of turns in the winding and the impressed voltage. The magnetizing current I_φ is determined by the flux and the reluctance of the magnetic circuit (equation 52 page 166). In any given transformer the voltage impressed fixes the flux and the magnetizing current must adjust itself to produce this flux. As a matter of practice, a modification of the dimensions of the iron core of a transformer will not be accompanied by a change in the flux but by a change in the magnetizing current required to produce the flux.

Equation (54) shows that for a fixed frequency the voltage per turn, *i.e.*, $\frac{E_1}{N_1}$, is proportional to the flux. The voltage per

turn multiplied by the number of turns must always be equal to the impressed voltage to within 1 or 2 per cent. The two would be exactly equal if the primary had neither resistance nor leakage reactance. If the turns are doubled the voltage induced per turn and the flux will be halved. If the turns are halved, the voltage induced per turn and the flux will be doubled, provided the increase in the saturation of the core is not sufficient to increase the magnetic leakage beyond the point where the relation $V_1 = -E_1$ is still approximately true.

Ratio of Transformation.—Both the primary and the secondary windings of a transformer are on the same iron core and are subjected to exactly the same variation in the mutual flux. Therefore, the voltages E_1 and E_2 induced in the two windings by the mutual flux must be in exact time phase. The voltage induced per turn in each winding must be the same.

$$\begin{aligned} \frac{E_1}{N_1} &= \frac{E_2}{N_2} \\ \frac{E_1}{E_2} &= \frac{N_1}{N_2} = a \end{aligned} \tag{55}$$

The ratio of the two induced voltages is called the ratio of transformation. It is fixed by the ratio of the turns in the primary and secondary windings. This is the true ratio of transformation and is constant. Commercially, the ratio of the terminal voltages is often called the ratio of transformation. This ratio is not constant but varies with the load and its power factor. Under ordinary conditions this variation is small and lies within 1 to 5 per cent.

The ratio of transformation, a , may be greater or less than unity, according as it is defined as the ratio of the voltage induced on the high-voltage side to the voltage induced on the low-voltage side, or *vice versa*. In America the ratio of the voltage induced in the high-voltage winding to the voltage induced in the low-voltage winding is ordinarily used. According to this definition the ratio of transformation of a transformer having ten times as many turns in one winding as in the other will be 10 and not 0.1.

Reaction of Secondary Current.—If the secondary circuit of a transformer is closed, a certain current I_2 will flow through the

N_2 secondary turns producing a magnetomotive force proportional to I_2N_2 acting to modify the flux in the core. From equation (53), page 182, the primary current is equal to

$$I_1 = \frac{V_1 + E_1}{r_1 + jx_1}$$

If the total magnetomotive force is altered, both φ and E_1 will change. According to the law of the conservation of energy, the change in E_1 must be of such a nature as to cause an increase in the primary power which is equal to the power developed by the secondary. Equilibrium will be established only when the increase in the internal power absorbed by the primary winding is just equal to the internal power developed by the secondary. Let I'_1 be the component which is added to the primary current due to the secondary load. This will be called the load component of the primary current. This component of the primary current will cause a magnetomotive force $N_1I'_1$ which will oppose the magnetomotive force N_2I_2 produced by the secondary current. Equilibrium will be established when the two magnetomotive forces are equal and opposite. Under this condition, the mutual flux will still be produced by the magnetizing component of the primary current and will only be changed slightly from its no-load value. The smaller r_1 and x_1 , the smaller will be the change in φ and I_φ for any change in load. The maximum variation in the mutual flux of transformers of ordinary design will not as a rule exceed 3 per cent. For equilibrium

$$N_1I'_1 = -N_2I_2 \quad (56)$$

Solving equation (56) for the ratio of the two currents gives

$$-\frac{I'_1}{I_2} = \frac{N_2}{N_1} = \frac{1}{a}$$

The load component of the primary current is, therefore, opposite in phase to the secondary current and equal to that current multiplied by the inverse ratio of transformation.

Reduction Factors.—When making transformer calculations and when drawing vector diagrams, it is convenient and often necessary to reduce all currents, voltages, resistances and reactances to the corresponding currents, voltages, resistances and reactances of an equivalent transformer having a ratio of trans-

formation equal to unity. An equivalent transformer is one which has the same rating, the same losses and the same regulation as the transformer it replaces. Usually one of the windings of this equivalent transformer is the same as the corresponding winding on the actual transformer. To make the substitution, it is only necessary to replace all currents, voltages, resistances and reactances of either of the windings of the actual transformer by their equivalent values in terms of the other winding. This is accomplished by multiplying each by its proper reduction factor.

Induced voltages are proportional to the number of turns in the windings of a transformer. Load currents are inversely proportional to the number of turns. Therefore, if an equivalent winding is to be substituted for one of the actual windings of a transformer, the ratio of the voltage induced in the equivalent winding to the voltage induced in the actual winding will be the same as the ratio of turns in the two windings. Since the equivalent winding must give the same regulation as the actual winding, all component voltages induced in it must be in the same ratio to one another as they were in the actual winding. Therefore, not only will the induced voltages in the two windings be in the ratio of turns, but all component voltages will also be in this same ratio. For a similar reason, all corresponding currents or component currents must be in the inverse ratio of turns. If a transformer is to be replaced by an equivalent transformer having a ratio of transformation of 1, the ratio of the turns on the equivalent winding to the turns on the winding it replaces will be equal to the inverse ratio of transformation of the actual transformer. It follows from this that to reduce resistances and reactances to their equivalent values the inverse square of the ratio of transformation must be used.

If the primary winding is the high-voltage winding, then to refer primary voltages, currents, resistances and reactances to their equivalent in terms of the secondary, multiply

Primary voltages by $\frac{1}{a}$

Primary currents by a

Primary resistances by $\left(\frac{1}{a}\right)^2$

Primary reactances by $\left(\frac{1}{a}\right)^2$

The inverse of these reduction factors will, of course, be used to reduce from secondary to primary.

Relative Values of Resistances.—The temperature reached under load conditions is an important item in determining the limiting output of any piece of electrical apparatus. For best economy of material, all parts should reach their ultimate safe temperatures at the same time under the limiting condition of load. In the case of a transformer, the amounts of copper used in the primary and secondary windings should be so proportioned that each winding will reach its limiting temperature at the same time under the maximum load to be carried. If one winding is still cool when the other has reached its ultimate safe temperature, an unnecessarily large amount of copper has been used in that winding.

If the conditions for the radiation and conduction of heat from the two windings of a transformer are the same, the copper loss in the primary and secondary windings of a properly designed transformer should be equal at full load.

For this condition

$$\begin{aligned} I_1^2 r_1 &= I_2^2 r_2 \\ \frac{I_2^2}{I_1^2} &= \frac{r_1}{r_2} \end{aligned}$$

Since I_1 and I'_1 are very nearly equal at full load, the following approximate relation should hold

$$\frac{I_2^2}{I'^2_1} = \frac{r_1}{r_2} = a^2$$

The actual ratio of r_1 to r_2 is a matter of design. It may differ somewhat from this ratio for one reason or another.

Relative Values of the Leakage Reactances.—Reactance is proportional to the flux linkages per ampere with a winding and hence is proportional to the number of turns in a winding multiplied by the flux per ampere which links with those turns.

Fig. 95 is a section through a core-type transformer having a primary and a secondary winding on each leg of the core.

The space between the windings and between the secondary and the core is occupied by insulation. The primary and secondary coils carry currents which are nearly opposite in phase and which produce magnetomotive forces which are nearly equal and

opposite. The magnetomotive forces would be equal if it were not for the small components of the primary current which supply the flux and the core loss.

Consider the two windings on the left-hand leg of the core. Let these be wound right-handedly if looked at from the top, also let the current in the secondary be right-handed at the instant considered. The leakage flux of the secondary will then pass upward through the annular space left between the two coils and will return through the iron core.

There will also be some leakage flux which will pass through the secondary turns. The primary current will be left-handed and the leakage flux due to it will also pass upward through the space between the two windings and also upward through the turns of the winding and will return outside of the primary. The direction of the flux is easily determined by the cork-screw rule, but it must be remembered

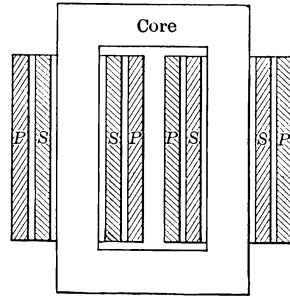

FIG. 95.

in applying this rule that the secondary leakage flux which passes between the two windings is outside of the secondary coil.

The reluctance of the return path for the leakage flux which links with the primary may be assumed to be negligibly small. The return path for the secondary leakage flux is the iron core and its reluctance may also be neglected when compared with the reluctance of that path lying between the two windings. The reluctance of the leakage paths will be the reluctance of that portion of the paths which lies between the two windings. It will, therefore, be constant. The magnetomotive force causing the primary leakage flux is proportional to the product of the primary current and the primary turns, or to $N_1 I_1$. Similarly, the magnetomotive force causing the secondary leakage flux is proportional to $N_2 I_2$. The linkages per ampere due to these magnetomotive forces will, therefore, be proportional to N_1^2 and N_2^2 . If the lengths of the primary and the secondary windings were equal, and the mean length of their turns were the same, the leakage reactances would be related to each other as the square of the ratio of transformation. The

actual leakage reactances will be very nearly in the ratio of the square of the ratio of transformation. This is the relation which is assumed to exist between them when it is necessary to make any assumption in regard to their relative magnitudes.

Calculation of Leakage Reactance.—In calculating the leakage reactance of a transformer coil, the leakage flux is assumed to be parallel to the axis of the coil and the reluctance of its path is assumed to be the reluctance of that part of the path which lies between the ends of the coil. The reluctance of the return path is neglected. Fig. 96 represents a section through two coils of a core-type transformer and one leg of the core. The dimensions of the two coils are indicated on the figure by letters. The inside coil is the secondary. N_1 and N_2 will be used for the number of turns on the primary and secondary coils respectively.

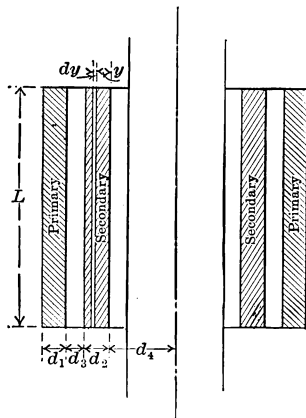

FIG. 96.

Consider an element of the secondary winding of thickness dy and radius $(d_4 + y)$. The reluctance of this element is

$$\frac{L}{2\pi(d_4 + y)dy}$$

The magnetomotive force per c.g.s. unit of current is

$$4\pi \frac{N_2 y}{d_2}$$

The flux through the element per unit current is

$$8\pi^2 \frac{N_2 (d_4 + y)y}{d_2 L} dy$$

This flux links $\frac{N_2 y}{d_2}$ turns; therefore, the linkages for the element are

$$8\pi^2 \frac{N_2^2 (d_4 + y)y^2}{d_2^2 L} dy$$

The self-induction which is due to the flux that passes through the coil will be the integral of the preceding expression between the limits $y = 0$ and $y = d_2$. The self-induction in henries is this result multiplied by 10^{-9} . This is equal to

$$\begin{aligned} & 8\pi^2 \frac{N_2^2}{d_2^2 L} \int_0^{d_2} (d_4 + y)y^2 dy \cdot 10^{-9} \\ & = 8\pi^2 \frac{N_2^2}{L} \left\{ \frac{d_4 d_2}{3} + \frac{d_2^2}{4} \right\} 10^{-9} \end{aligned} \quad (57)$$

The magnetomotive force acting along the space between the coils is produced by the primary and secondary windings in parallel and is equal to

$$4\pi N_1 I_1 = 4\pi N_2 I_2$$

Per unit current this is $4\pi N_2$. The reluctance of the path on which this acts is

$$\frac{L}{2\pi(d_4 + d_2 + \frac{1}{2}d_3)d_3}$$

and the flux through this path is

$$\frac{8\pi^2 N_2 (d_4 + d_2 + \frac{1}{2}d_3)d_3}{L}$$

Since the return paths for the leakage fluxes are of negligible reluctance, half of this flux can be assumed to link with the primary winding and half with the secondary. Therefore, the part of the secondary self-inductance which is due to this is

$$\frac{4\pi^2 N_2^2 (d_4 + d_2 + \frac{1}{2}d_3)d_3}{L} 10^{-9}$$

The leakage reactance in ohms of the whole secondary winding is

$$2\pi f \left\{ \frac{8\pi^2 N_2^2}{L} \left[\left(\frac{d_4 d_2}{3} + \frac{d_2^2}{4} \right) + \frac{1}{2} (d_4 + d_2 + \frac{1}{2}d_3)d_3 \right] \right\} 10^{-9} \quad (58)$$

The leakage reactance of the primary may be found in a similar manner. It will be

$$\begin{aligned} 2\pi f \left\{ \frac{8\pi^2 N_1^2}{L} \left[\frac{(d_4 + d_2 + d_3)d_1}{3} + \frac{d_1^2}{12} \right. \right. \\ \left. \left. + \frac{1}{2} (d_4 + d_2 + \frac{1}{2}d_3)d_3 \right] \right\} 10^{-9} \end{aligned} \quad (59)$$

It will be seen from equations (58) and (59) that the ratio of the primary and secondary reactances would be the same as the ratio of transformation squared if it were not for the first two terms under the brackets involving the d 's. These two terms can be equal only when the thickness and the mean length of the turns of each winding are the same. As has already been stated, the ratio of the reactances will be nearly equal to the square of the ratio of transformation.

The calculation of the leakage reactance by the method just outlined takes no account of the leakage between the turns of the

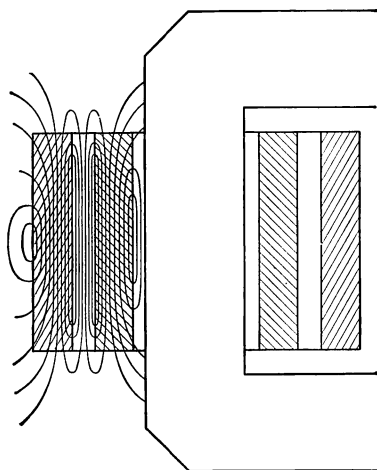

FIG. 97.

winding. All of the leakage flux was assumed to be parallel to the sides of the coils. In reality a considerable portion of the flux will pass between the turns as is indicated in Fig. 97.

On account of the leakage between turns, the reactance calculated by formula (59) ought to be multiplied by a constant which is less than unity. The value of this constant will depend upon the size and shape of the windings.

Load Vector Diagram.—The complete vector diagram of a transformer is shown in Fig. 98. The resistance and reactance drops and the core-loss components of the primary current are exaggerated in order to make the diagram clearer.

It is customary when drawing vector diagrams to reduce all vectors to their equivalents in terms of either the primary or the secondary windings. In Fig. 98 all vectors are considered with respect to the secondary and are referred to that side of the transformer.

The magnetomotive force $N_2 I_2$ of the secondary winding is just balanced by the opposite and equal magnetomotive force in the primary winding due to the load component of the primary current. Since these two magnetomotive forces neutralize each other, they may be omitted from the diagram. The resultant magnetomotive force which produces the mutual flux ϕ is $N_1 I_\phi$.

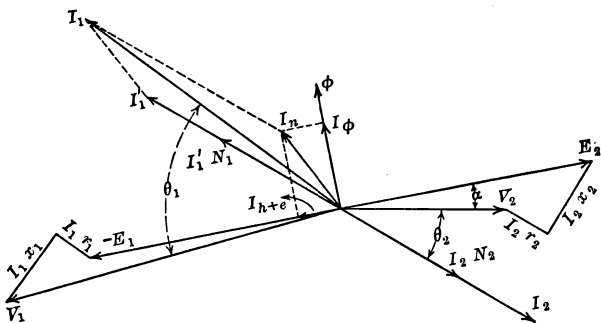

FIG. 98.

Analysis of the Vector Diagram.—The primary power, P_1 , is

$$P_1 = V_1 I_1 \cos \theta_1 = V_1 I_1 \cos \theta_{I_1}^{V_1}$$

Resolving V_1 into its components gives

$$P_1 = E_1 I_1 \cos \theta_{I_1}^{E_1} + (I_1 r_1) I_1 \cos 0 + (I_1 x_1) I_1 \cos \frac{\pi}{2} \quad (60)$$

If I_1 in the first member of equation (60) is replaced by its components, the equation may be further expanded to give

$$P_1 = E_1 I_1' \cos \theta_{I_1'}^{E_1} + E_1 I_{h+e} \cos 0 + E_1 I_\phi \cos \frac{\pi}{2} \\ + (I_1 r_1) I_1 \cos 0 + (I_1 x_1) I_1 \cos \frac{\pi}{2}$$

$$= \left\{ \begin{array}{l} \text{Power trans-} \\ \text{ferred to sec-} \\ \text{ondary by} \\ \text{magnetic in-} \\ \text{duction} \end{array} \right\} + \left\{ \begin{array}{l} \text{core} \\ \text{loss} \end{array} \right\} + \left\{ \text{zero} \right\}$$

$$+ \left\{ \begin{array}{l} \text{primary} \\ \text{copper loss} \end{array} \right\} + \left\{ \text{zero} \right\}$$

$$E_1 I'_1 \cos \theta_{I'_1}^{E_1} = E_2 I_2 \cos \theta_{I_2}^{E_2} = P'_2$$

where P'_2 is the total secondary power.

E_2 may now be expanded giving

$$P'_2 = (I_2 r_2) I_2 \cos 0 + (I_2 x_2) I_2 \cos \frac{\pi}{2} + V_2 I_2 \cos \theta_{I_2}^{V_2}$$

$$= \left\{ \begin{array}{l} \text{Secondary} \\ \text{copper loss} \end{array} \right\} + \left\{ \text{zero} \right\} + \left\{ \begin{array}{l} \text{secondary} \\ \text{output} \end{array} \right\}$$

Solution of the Vector Diagram and Calculation of Regulation.—Take V_2 as an axis of reference.

$$V_2 = V_2 + j0$$

$$I_2 = I_2 (\cos \theta_2 - j \sin \theta_2)$$

$$E_2 = V_2 + I_2 z_2$$

$$= V_2 + I_2 (\cos \theta_2 - j \sin \theta_2)(r_2 + jx_2)$$

$$= V_2 + I_2 (r_2 \cos \theta_2 + x_2 \sin \theta_2) + jI_2 (x_2 \cos \theta_2 - r_2 \sin \theta_2)$$

$$= A + jB \tag{61}$$

where A and B are, respectively, the real and imaginary terms of equation (61).

$$-E_1 = -E_2 a$$

$$= -(A + jB)a$$

The load component I'_1 of the primary current is

$$I'_1 = -\frac{1}{a} I_2$$

$$= -\frac{1}{a} I_2 (\cos \theta_2 - j \sin \theta_2)$$

Let $I_n = -I_{h+e} + jI_\varphi$ be the exciting component of the primary current measured at a voltage $E_1 = aE_2 = a(A + jB)$, and let P be the core loss also measured at the voltage E_1 .

Then

$$I_{h+c} = \frac{P}{E_1}$$

and

$$I_\varphi = \sqrt{I_n^2 - I_{h+c}^2}$$

I_n referred to E_2 as an axis it is

$$I_n = -I_{h+c} + jI_\varphi$$

Referred to V_2 as an axis it is

$$-I_{h+c}(\cos \alpha + j \sin \alpha) + jI_\varphi(\cos \alpha + j \sin \alpha)$$

where

$$\sin \alpha = \frac{B}{\sqrt{A^2 + B^2}}$$

and

$$\cos \alpha = \frac{A}{\sqrt{A^2 + B^2}}$$

$$\begin{aligned} I_1 &= I'_1 + I_n \\ &= -\frac{1}{a}I_2 + I_n \\ &= -\frac{1}{a}I_2(\cos \theta_2 - j \sin \theta_2) \\ &\quad - I_{h+c}(\cos \alpha + j \sin \alpha) \\ &\quad + jI_\varphi(\cos \alpha + j \sin \alpha) \\ &= -\left(\frac{I_2}{a} \cos \theta_2 + I_{h+c} \cos \alpha + I_\varphi \sin \alpha\right) \\ &\quad + j\left(\frac{I_2}{a} \sin \theta_2 - I_{h+c} \sin \alpha + I_\varphi \cos \alpha\right) \quad (62) \\ &= C + jD \end{aligned}$$

C and D are respectively the real and imaginary parts of equation (62).

$$\begin{aligned} V_1 &= -E_1 + I_1(r_1 + jx_1) \\ &= -a(A + jB) + (C + jD)(r_1 + jx_1) \\ &= F + jG \end{aligned}$$

At no load E_1 and V_1 are very nearly equal since the no-load current of a transformer is small. The no-load current will be from 2 to 6 per cent. of the full-load current and the impedance drop in the primary due to this current will not be more than 0.1 or 0.2 per cent. of the rated primary voltage. Since

at no load $E_2 = V_2$ and E_1 and V_1 are approximately equal, the no-load secondary voltage corresponding to a primary voltage of V_1 is

$$\frac{1}{a}V_1$$

The regulation in per cent. is

$$\frac{\frac{1}{a}V_1 - V_2}{V_2} 100$$

In the actual solution of the transformer diagram the angle between E_2 and V_2 may be neglected so far as the phase of I_n is concerned, and the values of I_n and P may be taken for the rated voltage instead of for the voltage E_1 without producing any appreciable error.

CHAPTER XV

TRUE EQUIVALENT CIRCUIT OF A TRANSFORMER; GRAPHICAL REPRESENTATION OF THE APPROXIMATE EQUIVALENT CIRCUIT; CALCULATION OF REGULATION FROM THE APPROXIMATE EQUIVALENT CIRCUIT

The Equivalent Circuit of a Transformer.—If the resistances and the reactances of a transformer are assumed to be constant, it may be exactly represented by the circuit shown in Fig. 99. The secondary resistance, reactance, current and voltage as well as the resistance and reactance of the load are all reduced to their equivalent values in terms of the primary winding.

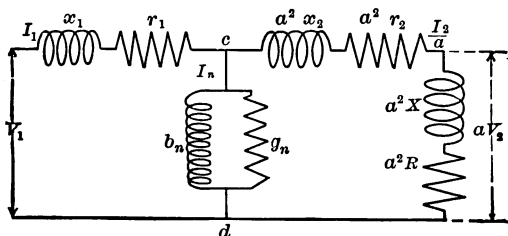

FIG. 99.

R and X are, respectively, the resistance and the reactance of the load, and g_n and b_n are, respectively, the conductance and susceptance of the circuit across cd , which takes a current equal to the exciting current of the transformer.

$$\begin{aligned} I_n &= E_1(g_n - jb_n) \\ I_{h+c} &= E_1g_n \\ I_\phi &= E_1b_n \end{aligned}$$

The potential across cd is equal to aE_2 and is, therefore, equal to E_1

$$\begin{aligned} E_1 &= aV_2 + \frac{I_2}{a} (a^2r_2 + ja^2x_2) \\ I_1 &= I'_1 + I_n = \frac{I_2}{a} + E_1(g_n - jb_n) \\ V_1 &= E_1 + I_1(r_1 + jx_1) \end{aligned}$$

Both $I_1 r_1$ and $I_1 x_1$ are small compared with V_1 . Hence, since I_n is also small, as a rule only a few per cent. of I_1 , the error of using I_n corresponding to the voltage V_1 instead of to the voltage E_1 will be negligible. For the same reason the error produced in V_1 by neglecting I_n and using I'_1 in place of I_1 will also be negligible. Therefore, the real equivalent diagram may be replaced by the approximate form shown in Fig. 100.

By combining x_1 with $a^2 x_2$ and r_1 with $a^2 r_2$, the diagram may be modified still further giving the one shown in Fig. 101.

$x_1 + a^2 x_2 = x_e$ and $r_1 + a^2 r_2 = r_e$ are called, respectively, the equivalent reactance and the equivalent resistance of the trans-

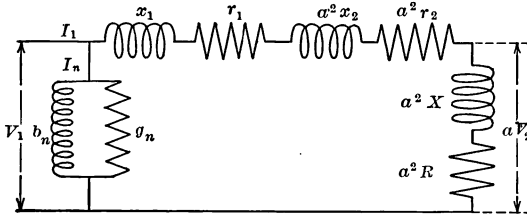

FIG. 100.

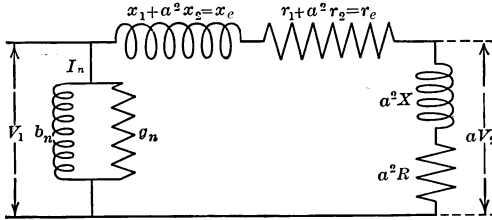

FIG. 101.

former. In Fig. 101, x_e and r_e are referred to the primary side of the transformer and must be used with the primary current or with the secondary current referred to the primary side.

If everything on the diagrams shown in Figs. 99, 100 and 101 had been referred to the secondary side, the equivalent resistance and the equivalent reactance would also have been referred to the secondary side. Referred to the secondary, x_e and r_e are

$$x_e = \frac{x_1}{a^2} + x_2$$

$$r_e = \frac{r_1}{a^2} + r_2$$

The secondary current must be used with the equivalent reactance and the equivalent resistance when they are referred to the secondary winding.

Graphical Representation of the Approximate Equivalent Circuit.—The vector diagram of a transformer with the exciting circuit.

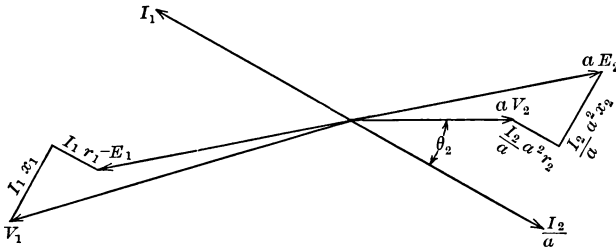

FIG. 102.

current omitted is shown in Fig. 102. Everything on this diagram is referred to the primary side.

Let the left-hand side of this diagram be revolved through 180 degrees or until the vector $-E_1$ coincides with aE_2 . The result of this rotation is shown in Fig. 103.

If the two resistance drops and the two reactance drops are

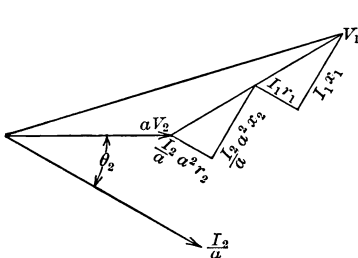

FIG. 103.

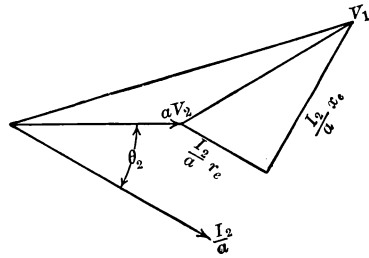

FIG. 104.

replaced by the equivalent resistance drop and the equivalent reactance drop, the diagram shown in Fig. 103 still further simplifies to that shown in Fig. 104.

The vector diagram given in Fig. 104 represents the conditions existing in the approximate equivalent circuit of a transformer shown in Fig. 101. The exciting current has been left off

Figs. 102, 103 and 104 since in the approximate diagrams it does not influence the secondary voltage.

Calculation of the Regulation from the Approximate Equivalent Circuit.—

$$V_1 = aV_2 + \frac{I_2}{a}(\cos \theta_2 - j \sin \theta_2)(r_e + jx_e) \quad (63)$$

and the regulation in per cent. is

$$\frac{V_1 - aV_2}{aV_2} 100$$

If it is more convenient, all vectors may be referred to the secondary side. In this case

$$\frac{V_1}{a} = V_2 + I_2(\cos \theta_2 - j \sin \theta_2)(r_e + jx_e) \quad (64)$$

$$\frac{\frac{V_1}{a} - V_2}{V_2} 100 \text{ is the regulation per cent.}$$

The values of r_e and x_e in equations (63) and (64) are not the same. In equation (64) both r_e and x_e are referred to the secondary and are $\frac{1}{a^2}$ times as large as they are in equation (63) where they are both referred to the primary.

In so far as voltage regulation is concerned, a transformer may be replaced by a series impedance coil having a resistance equal to r_e and a reactance equal to x_e .

The approximate method of calculating the regulation of a transformer gives results which are nearly enough correct except when applied to transformers having excessive exciting currents or very large resistance and leakage-reactance drops. In the latter case, the approximate method should not be used for calculating the regulation of a transformer.

Some idea of the closeness with which the values of the regulation of a transformer calculated by the correct and approximate methods check may be obtained from Table IX which gives the regulation calculated by both methods of a 10-kv-a., 60-cycle transformer such as might be used for lighting or power.

TABLE IX

Regulation	Power factor	Method
4.41	0.8	Correct
4.37	0.8	Approximate

The difference between the values of the regulation calculated by the two methods is only 1 per cent., and is less than the error of measuring the regulation of a transformer by applying a load.

CHAPTER XVI

LOSSES IN A TRANSFORMER; EDDY-CURRENT LOSS; HYSTERESIS LOSS; SCREENING EFFECT OF EDDY CURRENTS; EFFICIENCY; ALL-DAY EFFICIENCY.

The Losses in a Transformer.—The losses in a transformer are:

- (a) Core loss.
- (b) Primary copper loss.
- (c) Secondary copper loss.

The first of these is nearly constant and independent of the load. The second two vary as the square of their respective currents.

The core loss is caused by the variation of the flux in the iron core and depends upon the frequency, the maximum value of the flux wave, the quality of the iron, the thickness of the laminations and the volume or weight of the core. The iron losses may be separated into losses due to eddy currents and losses due to hysteresis. Each of these components follows different laws.

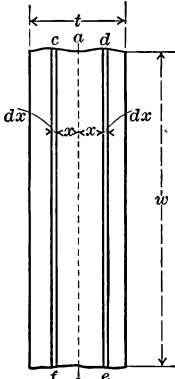

FIG. 105.

Eddy-current Loss.—Let Fig. 105 represent a section, taken perpendicular to the flux, through one of the thin plates which form the laminated iron core.

Let t be the thickness of the plate and w its width measured perpendicular to the flux, which is assumed to be perpendicular to the paper.

Both t and w are expressed in centimeters. Consider two elements, one on each side of a line ab drawn through the middle of the plate parallel to its sides. Let the distance of these two elements from the line ab be x and let their width be dx .

The flux which is enclosed between these two elements will cause an eddy current to circulate in the circuit $cdef$ of which the elements form two sides. If the thickness of the plate is small compared with its width, the length of the path for the eddy current may be considered to be equal to twice the length of the elements or equal to $2w$.

Let the flux density, b , be assumed constant throughout the laminations and let it be, at any instant, a function of the maximum flux density, \mathfrak{B}_m , and the time, t .

The voltage induced in the elementary circuit due to this flux density will be

$$e = - \frac{d}{dt} (2xwb)$$

If the flux is a sine function, *i.e.*, if $b = \mathfrak{B}_m \sin \omega t$, the root-mean-square value of the voltage e will be

$$E = 2xw \frac{2\pi}{\sqrt{2}} f \mathfrak{B}_m$$

Assume that the flux produced by the eddy currents is so small that the lag of the eddy currents behind the voltage producing them may be neglected. Under this assumption, the eddy current in the element $cdef$ may be found by dividing the voltage in this element by its resistance.

Let the specific conductivity of the iron in c.g.s. units be K . Then the resistance of the elementary circuit $cdef$ per unit length measured along the flux will be

$$r = \frac{2w}{K} \frac{1}{dx}$$

The loss in the elementary circuit per unit length will be

$$\begin{aligned} \frac{E^2}{r} &= \frac{\left(2xw \frac{2\pi}{\sqrt{2}} f \mathfrak{B}_m \right)^2}{2w} K dx \\ &= 4wx^2 \pi^2 f^2 \mathfrak{B}_m^2 K dx \end{aligned}$$

The loss per unit length of lamination will be

$$\begin{aligned} &\int_0^t 4wx^2 \pi^2 f^2 \mathfrak{B}_m^2 K dx \\ &= \frac{w K t^3 \pi^2 f^2 \mathfrak{B}_m^2}{6} \text{ ergs per second.} \end{aligned}$$

If K is expressed in mhos per centimeter cube instead of c.g.s. units the loss, P_e , in watts per unit length of lamination will be

$$P_e = \frac{w K t^3 \pi^2 f^2 \mathfrak{B}_m^2}{6} 10^{-16}$$

The volume corresponding to this loss is wt . To find the loss, P'_e , per cubic centimeter divide P_e by wt .

$$P'_e = \frac{Kt^2\pi^2f^2\mathcal{B}_m^2}{6} 10^{-16}$$

It should be noticed that the eddy-current loss varies as the square of the thickness of the lamination. It also varies as the square of the maximum flux density and, therefore, for fixed frequency as the square of the induced voltage.

In the preceding calculation for P'_e certain assumptions were made, namely, that the magnetic effect of the eddy currents was negligible and that the flux was uniformly distributed throughout the laminations with the lines of force parallel to the sides of the plate. These assumptions are likely to be more or less deviated from in practice causing the measured loss due to eddy currents to be somewhat smaller than that found by the formula. The value of K for ordinary transformer steel is in the neighborhood of 10^5 mhos per centimeter cube. For silicon steel it is about one-third as large.

In deducing the expression for the eddy-current loss, a sine wave of flux was assumed. The eddy-current loss depends upon the root-mean-square value of the eddy currents produced by the flux and not upon the maximum value of the flux causing them; therefore, the eddy-current losses caused by fluxes having the same maximum values and the same frequency but different wave forms will be different. Assuming that the eddy currents produce no magnetization, their form factor will be the same as the form factor of the voltage induced in the windings by the flux.

Hysteresis Loss.—Let N be the number of turns on the coil producing the flux and let the flux density at any instant be equal to b . If A is the cross-section of the iron core measured perpendicular to the flux, the electromotive force induced in the coil will be

$$e = -NA \frac{db}{dt} \text{ abvolts.}$$

If i is the instantaneous value of the current corresponding to e , the power corresponding to this current will be

$$p = ei$$

The energy in ergs corresponding to this which is expended in a time dt is

$$pdt = eiddt$$

Assume that the reluctance of the magnetic circuit per unit length is constant. Then the magnetomotive force expended per unit length of the magnetic circuit to produce this flux will also be constant. The magnetomotive force producing the flux intensity b is

$$4\pi Ni = hl$$

where h and l are, respectively, the magnetizing force per unit length of magnetic circuit, or the intensity of field, and the length of the magnetic circuit in centimeters.

Solving the last expression for i gives

$$i = \frac{hl}{4\pi N}$$

If the values of e and i are substituted in the equation for the energy expended in the time dt , this equation becomes

$$\begin{aligned} pdt &= \frac{Al}{4\pi} h db \\ &= \frac{V}{4\pi} h db \end{aligned}$$

where V is the volume.

The expenditure of energy in ergs during a cycle per unit volume will be

$$\frac{1}{4\pi} \int h db$$

If the iron is carried through f magnetic cycles per second, the loss per second or the rate at which energy is expended will be

$$\frac{f}{4\pi} \int_{+\mathfrak{B}}^{+\mathfrak{B}} h db \cdot 10^{-7} \text{ watts.}$$

The integral represents the area enclosed by the hysteresis loop of the core plotted with flux densities as ordinates and field intensities as abscissæ.

It has been shown by Steinmetz that the hysteresis loss in iron can be represented by an empirical equation of the form

$$\begin{aligned} \eta f V \mathfrak{B}_m^x 10^{-7} \text{ watts.} & \qquad (65) \\ \eta f V \mathfrak{B}_m^x 10^{-7} &= \frac{fV}{4\pi} \int_{+\mathfrak{B}}^{+\mathfrak{B}} h db 10^{-7} \end{aligned}$$

Both η and x are constants. η is known as the hysteresis coefficient. Steinmetz has shown that the exponent x is about 1.6. Later experiments by Steinmetz, as well as others carried on by Ewing, have shown that x need not be exactly 1.6, but 1.6 is approximately correct for most iron unless the densities are much higher than ordinarily used. At very high magnetic densities the exponent appears to become considerably smaller than 1.6.

The hysteresis loss depends upon the maximum value of the flux and is independent of how this maximum is reached provided the change of flux between the limits of zero and maximum, and *vice versa*, is continuous and without reversal; in other words, provided there are no small loops in the hysteresis curve.

Since the hysteresis part of the core loss, and this is the largest part, depends upon the maximum value of the flux, the core losses corresponding to voltages impressed on the windings of an iron core will vary with the wave form of the impressed voltage even though the root-mean-square value of the voltage remains constant. A flat electromotive-force wave gives rise to a flux wave which is less flat and, *vice versa*, a peaked electromotive-force wave gives rise to a flux wave which is less peaked (page 172). Hence the core loss corresponding to a flat electromotive-force wave will be greater than the core loss corresponding to a peaked electromotive-force wave having the same root-mean-square value.

For any iron core the equation for the core loss may be written

$$P_{h+e} = V(k_h f \mathfrak{B}_m^{1.6} + k_e f^2 \mathfrak{B}_m^2) 10^{-7} \quad (66)$$

Table X gives the Steinmetz exponent, the eddy-current exponent and the hysteresis coefficient for ordinary transformer steel and silicon steel at ordinary flux densities. Table XI gives the losses per pound at 60 cycles and 10,000 gausses. The eddy-current losses are for plates of No. 29 gage.

TABLE X

	Ordinary annealed transformer steel	Silicon steel
Steinmetz exponent . . .	from 1.58 to 1.62	from 1.58 to 1.62
Eddy-current exponent.	from 1.82 to 2.02	
Hysteresis coefficient . . .	from 0.001 to 0.0022	from 0.0006 to 0.00095

TABLE XI
Watts per Pound of Iron at 60 Cycles and 10,000 Gausses for No. 29
Gage Plates

	Ordinary annealed transformer steel	Silicon steel
Eddy-current loss.....	from 0.34 to 0.70	from 0.12 to 0.18
Hysteresis loss.....	from 0.93 to 2.0	from 0.54 to 0.90

Silicon steels used for transformers contain from 3 to 4 per cent. of silicon.

The permeability of silicon steel is slightly lower at ordinary densities than the permeability of ordinary transformer steel. This tends to make the magnetizing current for silicon iron slightly larger than for ordinary iron.

Screening Effect of Eddy Currents.—In deducing the expressions for the eddy-current and hysteresis losses, the flux density was assumed to be uniform throughout the laminations. Although this assumption is approximately correct for very thin laminations, it is far from true when thick laminations are used.

The effect of the eddy currents on the flux is like the effect of the secondary current in a transformer. They tend to demagnetize the core. This demagnetizing action is greatest at the center of each lamination and is zero at its surface, since all of the eddy currents in any lamination flow in concentric paths about its center and, therefore, produce the greatest effect at that point. Any point in a lamination is subjected to a demagnetizing action which is due to the eddy currents in that portion of the lamination which lies without this point.

On account of this action of the eddy currents there is a diminution in the resultant magnetomotive force in passing from the surface to the center of a lamination. The flux density at the center of laminations of different thicknesses in per cent. of the density at the perimeter is given in Table XII for ordinary transformer iron, at 60 and 25 cycles.

From Table XII it is obvious that thicker laminations may be used for 25-cycle transformers than for 60-cycle transformers. With laminations less than 0.5 mm. thick, the decrease in flux in passing into any lamination is only a few per cent. for either 60 or 25 cycles. As the iron used for transformer cores is seldom

over 0.014 in. (0.36 mm.) thick, the flux density in the core of an ordinary transformer may be assumed to be constant without introducing any appreciable error.

TABLE XII¹

Maximum Flux Densities at the Center of Any Lamination in Terms of the Maximum Flux Density at its Surface

Thickness.....	2 mm.	1 mm.	0.5 mm.
60 cycles.....	0.18	0.61	0.96
25 cycles.....	0.30	0.89	0.99

Table XII is calculated for ordinary transformer iron. For silicon iron, such as is now almost universally used for cores, the variation in flux is much less than is indicated by the table, due to the high resistivity of such iron.

The effect of the diminution in flux density toward the center of each lamination is to increase the impressed magnetomotive force which is required for a given total flux in the core. The effect is the same, so far as the magnetizing current is concerned, as decreasing the cross-section of the core. Since the hysteresis loss varies as the 1.6 power of the maximum flux density, this loss will be greater for a given total flux than if the density were uniform. The eddy-current loss will be less, since for a given total flux the eddy currents will be the same at the surface and center of the laminations whether the flux density is uniform or not, and at every other point in the laminations they will be less. For these reasons, equation (66) will give an eddy-current loss which is greater and a hysteresis loss which is less than actually exist. The difference, however, between the actual core loss and that calculated by the equation is small for laminations of thicknesses ordinarily used, especially for silicon iron, and the error of neglecting this difference is negligible.

Efficiency.—The efficiency of a transformer is given by equation (67) where P_c is the core loss.

$$\frac{\text{Output}}{\text{Input}} = \frac{V_2 I_2 \cos \theta_2}{V_2 I_2 \cos \theta_2 + P_c + I_1^2 r_1 + I_2^2 r_2} \quad (67)$$

¹See Alternating Currents, Vol. I, Alexander Russell, p. 359.

The core loss in any given transformer depends upon the flux density, but on account of the primary and the secondary leakage fluxes, the flux may not be the same in all parts of the core. However, since the leakage fluxes in a transformer of ordinary design are small, the core loss may be considered to be due to the mutual flux, and what little extra core loss is produced by the leakage fluxes may be taken into account by using effective resistances instead of ohmic. The use of effective resistances is, however, seldom necessary.

In equation (67), P_c is the core loss corresponding to the mutual flux. The mutual flux is proportional to the induced voltage; therefore, the proper value of the core loss to use when finding the efficiency of a transformer is that corresponding to the induced voltage and not to the impressed. Little error will be introduced by using the core loss corresponding to the impressed voltage. Also, since the no-load or exciting component, I_n , of the primary current is small, the primary current may be replaced by its load component I'_1 . If this is done the primary and the secondary copper losses may be combined by replacing the primary and the secondary resistances by the equivalent resistance. Making this substitution gives equation (68).

$$\text{Efficiency} = \frac{V_2 I_2 \cos \theta_2}{V_2 I_2 \cos \theta_2 + P_c + I_2^2 r_e} \quad (68)$$

r_e is, of course, referred to the secondary winding and is equal to $\frac{r_1}{a^2} + r_2$. A still further approximation may be made by replacing the load terminal voltage by the no-load or rated voltage. The net effect of the three approximations should be slight and entirely negligible for ordinary commercial work. The error introduced by the approximations should not exceed $\frac{1}{10}$ or $\frac{3}{10}$ per cent. except at low power factors. The chief reason why the error is so small is that the total losses of a transformer are very small. The efficiency of ordinary commercial transformers varies from 95 to 99 per cent. With an efficiency of 95 per cent., an error as great as 10 per cent. in the losses would produce an error of only $\frac{1}{2}$ per cent. in the full-load efficiency.

The efficiency of a transformer may also be found from the solution of the transformer diagram given on pages 192 and 193. The power in any circuit when both the current and voltage are

expressed as complex quantities is equal to the sum of the products of the real and imaginary parts of the current and voltage. Applying this to the results given on pages 192 and 193 gives

$$\text{Efficiency} = \frac{\text{output}}{\text{input}} = \frac{V_2(I_2 \cos \theta_2) + 0(I_2 \sin \theta_2)}{FC + GD} \quad (69)$$

It is usually more convenient and much more satisfactory to calculate the efficiency by equation (68).

The hysteresis part of the core loss of a transformer is the larger of the two components, especially in transformers having silicon iron cores. It depends upon the 1.6 power of the maximum of the flux. Therefore, for the same root-mean-square induced voltage, the maximum flux and consequently the core loss will vary considerably for impressed voltages of different wave forms. For this reason, the difference between the actual wave form used and a sine wave should be stated in giving the efficiencies of transformers when accuracy is required. The efficiency of a transformer operated on a peaked electromotive-force wave will be appreciably higher than when measured on a flat electromotive-force wave. The difference may amount to as much as 0.2 per cent. in an extreme case.

The efficiency of a transformer which is, of course, zero at no load increases with the current output and reaches a maximum for that output at which the core and copper losses are equal. This may be proved by making use of equation (68). The core loss, P_c , and the secondary voltage V_2 will both be assumed constant. The maximum efficiency will occur for that value of the secondary current which makes the differential of the efficiency with respect to the secondary current zero. If η is the efficiency, the maximum efficiency will occur when $\frac{d\eta}{dI_2} = 0$. Differentiating equation (68) with respect to I_2 and equating the differential to zero gives

$$(V_2 I_2 \cos \theta_2 + P_c + I_2^2 r_e) V_2 \cos \theta_2 = V_2 I_2 \cos \theta_2 (V_2 \cos \theta_2 + 2I_2 r_e)$$

$$P_c = I_2^2 r_e$$

Transformers which are to be operated continuously under load should be designed to have equal core and copper losses at the average load at which they are to be used. Many transformers

are connected permanently to the mains and operate under no load or under very small loads a large part of the time. In such cases it is obviously impossible to reduce the amount of iron sufficiently to make the maximum efficiency occur for the average load, both on account of the large amount of copper required and the poor voltage regulation which would result. The full-load copper losses of such transformers are usually made somewhat greater than the core losses.

All-day Efficiency.—The all-day efficiency of a transformer is the ratio of the total kilowatt-hour output during 24 hours to the total kilowatt-hour input during the same period. Transformers, except those in central stations, are as a rule permanently connected to power mains on their primary sides and will consume power corresponding to their core losses during 24 hours of each day whether they are loaded or not. The all-day efficiency of transformers will, therefore, depend upon the distribution of their losses and upon the load factor at which they operate.

The all-day efficiency is numerically equal to the total kilowatt-hour output for 24 hours divided by the kilowatt-hour output for 24 hours, plus the core loss for 24 hours, plus the copper loss also for 24 hours.

In algebraic form this is

$$\frac{\Sigma t V_2 I_2 \cos \theta_2}{\Sigma t V_2 I_2 \cos \theta_2 + \Sigma t I_2^2 r_c + 24 P_c} \quad (70)$$

Reducing the number of turns on the windings of a transformer will decrease the copper loss but it will increase the flux density in the core and consequently the core loss. Usually if the turns are decreased the cross-section of the core will have to be increased in order to keep the flux density down. Increasing the number of turns will have the opposite effect. In general, decreasing the turns in both the primary and the secondary windings of a transformer in the same proportion decreases the all-day efficiency, while increasing the turns has the opposite effect.

The flux density used in the design of 60-cycle transformers is in the neighborhood of 70 kilolines per square inch. A little higher flux density may be used for lower frequency trans-

formers. The density may also be higher in large transformers with artificial cooling. The flux densities in kilolines per square inch used in the design of oil-cooled single-phase transformers are given in Table XIII.

TABLE XIII*

Rated output in kv-a.	25 cycles, primary voltage		50 cycles, primary voltage	
	2000	10,000	2000	10,000
5	77	77	71	68
20	87	84	74	71
50	90	87	74	72
100	90	87	76	74

The flux densities, regulation, losses, etc., at which ten transformers of standard design operate are given in Table XIV.

TABLE XIV

No. of transformer	Type	Rating, kw.	Frequency	Rated voltages	Ratio of trans- f'ion	$\frac{r_e \dagger}{x_e}$	Regulation p.f. = 1, p.f. = 0.7	
1	Core	25	60	$\frac{22,000}{440}$	50.0	0.32	1.51	4.09
2	Core	50	50	$\frac{30,000}{440}$	68.2	0.31	1.43	3.96
3	Core	50	$\frac{22,500}{230}$	97.8	0.63	1.74	3.10
4	Shell	100	60	$\frac{11,000}{2,200}$	5.0	0.38	1.04	2.53
5	Core	100	$\frac{11,000}{460}$	23.9	0.48	1.03	2.16
6	Core	500	$\frac{11,000}{2,300}$	4.78	0.22	0.72	2.59
7	Shell	500	$\frac{12,700}{2,300}$	5.52	0.38	0.97	2.36
8	Shell	500	25	$\frac{13,200}{425}$	31.1	0.11	1.37	6.57
9	Shell	1000	60	$\frac{66,000}{6600}$	10.0	0.15	0.87	3.98
10	Shell	5000	50	$\frac{52,000}{33,000}$	1.58	0.10	0.69	4.13

* From Design of Static Transformers by H. M. Hobart.

† r_e = equivalent resistance. x_e = equivalent reactance.

TABLE XIV (Continued)

No. of transformer	Core loss, watts	Copper loss, full load, watts	Efficiency p.f. = 1	$\frac{I_n^*}{I_1}$	Volts per turn	Max. flux density; lines per square inch.
1	371	351	97.1	0.068	3.2	69,500
2	641	665	97.4	0.060	4.7	70,100
3	968	850	96.4	0.080	5.8	
4	940	1,000	98.1	0.036	12.0	69,400
5	1,010	1,004	98.0	0.053	6.6	
6	2,960	3,375	98.7	0.015	14.8	
7	3,330	4,680	98.4	0.052	33.8	
8	2,500	4,600	98.6	0.032	23.6	77,000
9	9,300	7,490	98.3	0.062	54.2	73,200
10	17,500	27,000	99.1	0.029	98.3	72,300

The distribution of the losses in a transformer is often an important factor in determining the type of transformer which is most suitable for a given service. When transformers are connected only when loaded, it makes little difference, so far as the efficiency of operation is concerned, how the losses are distributed between the iron and copper, provided the total losses are not changed. When, however, transformers remain permanently connected to the power mains, as is usually the case except in central stations or substations, the distribution of the losses may have a very great influence on the economy of operation. For example, take as a specific case a 25-kv-a. transformer having a total full-load loss of 750 watts, two-fifths of which is core loss. Assume the transformer to operate under the following conditions during 24 hours:

- Full load..... 1 hour.
- One-half load..... 2 hours.
- One-quarter load..... 3 hours.
- No load..... 18 hours.

The all-day efficiency of this transformer for the specified load is, according to equation (70), page 209, 89.6 per cent. If three-fifths of the total loss had been core loss instead of two-fifths, the all-day efficiency would have been 85.9 per cent. With power at the switchboard at 1 c. a kilowatt-hour, the operating cost of this transformer for 1 year with the assumed load would be

* I_n = no-load current. I_1 = full-load primary current.

nearly \$12 more when three-fifths of the total losses were core loss than when only two-fifths were core loss. In a large station having many distributing transformers connected to its feeders, a slight change in the distribution of the losses in those transformers may easily make a difference of several thousands of dollars in the annual operating expenses, even though the cost of power at the switchboard is very low. Under certain conditions the greater cost of the transformers which will give the most desirable distribution of losses may more than offset the saving in the cost of operation by their use. In general, the most efficient piece of apparatus is not always the most economical one to install, as in some cases the increase in the interest on the investment necessary to obtain the increase in efficiency may more than balance the saving in the cost of power effected by the use of the more efficient apparatus.

CHAPTER XVII

MEASUREMENT OF CORE LOSS; SEPARATION OF EDDY-CURRENT AND HYSTERESIS LOSSES; MEASUREMENT OF EQUIVALENT RESISTANCE; MEASUREMENT OF EQUIVALENT REACTANCE, SHORT-CIRCUIT METHOD; MEASUREMENT OF EQUIVALENT REACTANCE, HIGHLY-INDUCTIVE-LOAD METHOD; OPPOSITION METHOD OF TESTING TRANSFORMERS

Measurement of Core Loss.—The power input to a transformer with its secondary open is equal to its core loss plus a very small copper loss in its primary winding which, under ordinary circumstances, is entirely negligible. The value of the core loss obtained in this way corresponds to a voltage which is equal to the voltage induced in the transformer coils. At no load this voltage does not differ appreciably from the voltage impressed across the terminals of the transformer.

Transformer No. 7, Table XIV, page 210, has about as large a copper loss in comparison with its core loss as any transformer in the table, and the no-load current of this transformer, expressed in per cent. of full-load current, is a little larger than the average no-load current of all the transformers. This current is 5.2 per cent. of the full-load current. Therefore, if the neglect of the no-load copper loss of this transformer, when determining its core loss, produces no appreciable error, it is fair to assume that in general the no-load copper loss can be neglected. As a rule, the full-load copper loss in a transformer is divided about equally between the two windings. If this assumption is made, the no-load copper loss of transformer No. 7 is

$$\frac{4680}{2}(0.052)^2 = 6.3 \text{ watts.}$$

or

$$\frac{6.3}{3330}100 = 0.19 \text{ per cent.}$$

of the core loss of the transformer.

When measuring the core losses of transformers, the copper losses in the measuring instruments must not be overlooked. Some of these losses will always be included in the power indicated by the wattmeter. In the case of small transformers, *i.e.*, 5 to 15 kw., neglecting to make proper correction for them may easily introduce an error of 5 to 10 per cent.

The Separation of Eddy-current and Hysteresis Losses.— From equation (66) page 204, the core loss for a core of fixed dimensions may be written

$$P_{h+c} = K_h f \mathfrak{B}_m^{1.6} + K_e f^2 \mathfrak{B}_m^2 \quad (71)$$

If the values of the two constants K_h and K_e can be determined, the total core loss P_{h+c} may be separated into its two components. These constants may be found for any given iron core by solving two simultaneous equations obtained by measuring the core loss, either at two different maximum flux densities and the same frequency or at two different frequencies and the same maximum flux density. Whichever method for obtaining the two equations is adopted, the wave form of the impressed electromotive force must be exactly the same during both determinations of the core loss.

Since the wave form must be the same in both determinations, the maximum flux density in the equation may be replaced by its value in terms of the frequency and the root-mean-square voltage induced in the winding by the flux.

$$E = 4 \text{ (form factor) } N \varphi_m f 10^{-8}$$

For any fixed wave form and number of turns this may be written

$$E = k_1 \mathfrak{B}_m f$$

and

$$\mathfrak{B}_m = \frac{1}{k_1} \frac{E}{f}$$

Substituting this value of \mathfrak{B}_m in the equation for the core loss gives

$$P_{h+c} = K'_h f^{-0.6} E^{1.6} + K'_e E^2 \quad (72)$$

It must be remembered that equation (72) holds only for a fixed wave form and a definite iron core. The constants will be different for different wave forms and for different cores.

In any properly designed transformer, the impressed and induced voltages may be considered equal at no load; therefore, E may be replaced in equation (72) by the impressed voltage without introducing any appreciable error.

In order to vary the flux at constant frequency, it is necessary to change the impressed voltage. This cannot be done by putting resistance or reactance in series with the transformer since any harmonics in the current would appear in the drop in potential through the resistance or reactance and would consequently be present in the voltage impressed across the transformer. It has already been shown that the current producing the flux in a transformer contains marked harmonics, especially the third, even though the voltage impressed across its terminals is sinusoidal.

The voltage impressed across the terminals of a transformer may be varied without changing its wave form by using a transformer which is large compared with the current to be taken from it, or by varying the excitation of a generator which is large enough for its voltage not to be influenced by the armature reaction caused by the current taken by the transformer.

If the core loss is to be separated into its components by measuring it at two different frequencies, it will be necessary to vary the voltage directly in proportion to the frequency in order to keep the flux density constant. If the other method is adopted, *i.e.*, measuring the core loss at two different flux densities, it will merely be necessary to measure it at two different voltages at the same frequency. The first method is the better as it does not involve any assumption in regard to the value of the Steinmetz exponent.

If the separation is to be made at constant density, a graphical method is preferable provided a sufficient range of frequency is available. Let equation (71) be divided by the frequency. This gives equation (73), which is the expression for the core loss per cycle.

$$\frac{P_{h+e}}{f} = K_h \mathfrak{B}_m^{1.6} + K_e f \mathfrak{B}_m^2 \quad (73)$$

Equation (73) is an equation of the first degree with respect to f and if plotted with $\frac{P_{h+e}}{f}$ as ordinates and f as abscissæ will give

a straight line. The intercept of this line on the axis of ordinates will be $K_h \beta_m^{1.6}$. $K_e f \beta_m^2$ is equal to the ordinate at a point on the line for a frequency f minus the intercept oa . Equation (73) is plotted in Fig. 106.

Referring to Fig. 106, oa and cd both multiplied by the frequency f are, respectively, the hysteresis and the eddy-current losses corresponding to that frequency.

Measurement of Equivalent Resistance.—The equivalent resistance of a transformer may be calculated from the ohmic resistance of its primary and secondary windings, but it is sometimes better to measure it directly in order to include all local eddy-current losses or hysteresis losses which are produced in the conductors or in the iron core by the currents in the primary

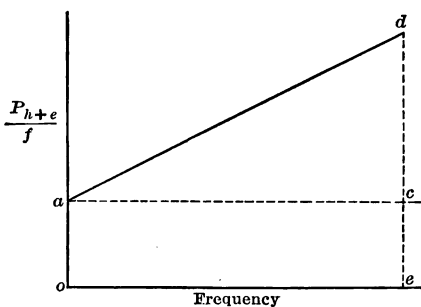

FIG. 106.

and the secondary windings. The equivalent resistance, including these local losses, may be obtained from measurements made with the transformer short-circuited.

The vector diagram of a short-circuited transformer is shown in Fig. 107.

The flux in a short-circuited transformer is merely that required to produce a voltage equal to the impedance drop in the secondary (Fig. 107). The secondary impedance drop will be approximately equal to one-half of the total impedance drop in the transformer. This total impedance drop is equal to the impressed voltage and, as a rule, it will not be over 4 or 5 per cent. of the rated voltage of the transformer even with full-load current in the short-circuited winding. The secondary induced voltage is only half of this or from 2 to $2\frac{1}{2}$ per cent.

of the rated voltage. Since the flux is proportional to the induced voltage and since the core loss produced by a flux varies between the 1.6 and 2 power of the flux, the core loss in a short-circuited transformer is entirely negligible in comparison with the copper loss. The input to a short-circuited transformer will, therefore, be equal to the total copper loss corresponding to the short-circuit current plus all local losses that are produced by the short-circuit current. If P and I are, respectively, the input and the short-circuit current both measured on the side of the transformer to which the power is supplied, the equivalent resistance referred to that side is $\frac{P}{I^2}$.

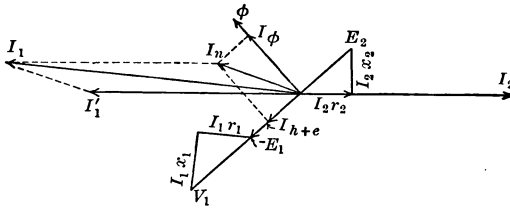

FIG. 107.

Measurement of Equivalent Reactance, Short-circuit Method.

—When a transformer is short-circuited

$$V_1 = aI_2z_2 + I_1z_1 = I_1z_e$$

z_e is the equivalent impedance and is referred to the primary side since I_1 is the primary current.

$$z_e = \frac{V_1}{I_1}$$

and

$$x_e = \sqrt{z_e^2 - r_e^2}$$

If the primary and the secondary leakage reactances x_1 and x_2 are assumed to be proportional to the square of the number of turns in the two windings, the equivalent reactance may be divided into its two component parts.

Although the short-circuit method of determining the leakage reactance of a transformer necessitates the use of very low saturation, the value of the reactance given by it will differ only

slightly from the value corresponding to normal saturation since the reluctance of the path of the leakage flux in most transformers is nearly independent of the saturation of the iron core.

Measurement of Equivalent Reactance, Highly Inductive-load Method.—The simplified vector diagram of a transformer delivering a highly inductive load is shown in Fig. 108. Everything on the diagram is referred to the secondary winding.

The equivalent reactance may be calculated from the following equation which is approximately true when applied in an algebraic sense to a transformer which carries a very highly inductive load (Fig. 108).

$$\frac{V_1}{a} - V_2 = x_e I_2$$

The advantage of this method is that it gives a value of reactance which corresponds to very nearly normal saturation of the trans-

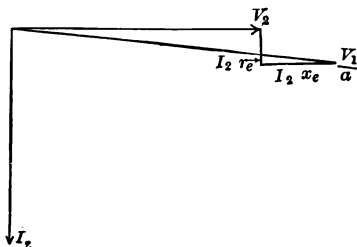

FIG. 108.

former core. The disadvantage is that it necessitates the subtraction of two voltages, $\frac{V_1}{a}$ and V_2 , which are very nearly equal, and any error in the determination of either will be very much exaggerated in their difference.

Opposition Method of Testing Transformers.—The limit of the output of a transformer is determined by the rise in temperature of its parts and by its regulation. Of the two, the temperature rise is by far the more important in most cases.

The methods for determining the regulation of a transformer have already been given. In order to obtain the increase in temperature of a transformer under load, it is necessary to operate it under conditions which produce normal full-load

heating for a sufficient length of time for the temperature of its parts to become constant. This will require from 2 to 3 hours for small transformers to 24 hours or longer for very large transformers. When merely the ultimate temperatures are desired, the time required to make a heat run may be reduced considerably by accelerating the heating during the first part of the test by operating at overload.

Small transformers may be tested by applying an actual load, but when large transformers have to be tested, the cost of the power required for loading becomes prohibitive. In such cases, the opposition method may be used, provided two similar transformers are available. A modification of this method may be applied to a single transformer if it has two primary and two

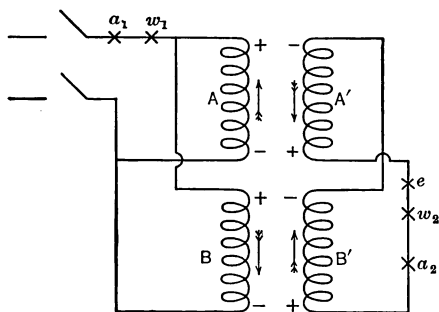

FIG. 109.

secondary windings. The opposition method is equally applicable to small transformers as to large and it is in very general use. It requires merely enough power to supply the core and copper losses of the two transformers being tested.

For the opposition method, the primary windings of the two transformers are connected in parallel to mains of the proper voltage and frequency. The secondary windings are then connected in series with their voltages opposing. Fig. 109 gives the proper connections.

A and A' represent the primary and secondary windings, respectively, of one transformer; B and B' are the corresponding windings of the other.

If the secondary windings are opposed with respect to the series circuit, they are virtually on open circuit so far as their

primaries are concerned, and no current will flow in them when the primaries are excited. So far as the secondaries are concerned, the primaries are virtually short-circuited with respect to any current which is sent through the secondaries.

The correctness of these two statements will be made clear by referring to Fig. 109. The plus and minus signs on this figure merely indicate the polarity of the transformer windings at some particular instant. The arrows show the direction of the current which would be produced at some instant by inserting an alternating electromotive force anywhere in the secondary circuit, as at e . By following through the circuit in the direction of the arrows, it will be seen that the transformers are short-circuited so far as the electromotive force inserted at e is concerned. The secondary voltages are in opposition when considered with respect to the electromotive force impressed on the primaries. Therefore, if the rated voltage is applied to the primary windings, the transformers will be operating under normal conditions so far as core loss is concerned. If, at the same time, the voltage inserted at e is adjusted so that full-load current exists in the secondaries, full-load current will also exist by induction in the primary windings and the transformers will be operating under conditions of full load so far as the copper loss is concerned.

The only power required under these conditions is that necessary to supply the core loss, which is measured by a wattmeter placed in the primary circuit at w_1 , and the power required to supply the copper loss. This latter will be measured by a wattmeter at w_2 with its potential coil connected about the source of electromotive force at e . One-half of the reading of the wattmeter at w_2 divided by the square of the current measured by an ammeter in series with it will be the equivalent resistance of one transformer. A voltmeter connected about the source of electromotive force at e will record twice the equivalent impedance drop in one transformer. The reading of this instrument divided by twice the current in the circuit, given by an ammeter placed at a_2 , will be the equivalent impedance of one transformer. An ammeter placed at a_1 , in the primary circuit, will record twice the no-load current of one transformer.

The temperature rise may be obtained both by thermometers

and from resistance measurements. The resistances for the calculation of the temperature rise may either be obtained from measurements made by any suitable method at the beginning and at the end of the run or from the readings of the wattmeter and the ammeter placed at w_2 and a_2 respectively.

The best way to obtain the voltage required at e is to insert the secondary of a suitable transformer at that point. The voltage may be varied by a resistance in series with the primary of this auxiliary transformer.

If the core losses are put in on the low-voltage side of the transformers and the voltage at e is obtained from a third transformer, all necessity for handling high-voltage circuits when adjusting for load conditions is avoided.

CHAPTER XVIII

CURRENT TRANSFORMER; POTENTIAL TRANSFORMER; CONSTANT-CURRENT TRANSFORMER; AUTO-TRANSFORMER; INDUCTION REGULATOR

Current Transformer.—Current transformers are used with alternating-current instruments and serve the same purpose as shunts with direct-current instruments. When a current transformer is used, its primary winding is placed in the line carrying the current to be measured and its secondary is short-circuited through the instrument which is to measure the current. Current transformers serve the double purpose of increasing the current range of an instrument and insulating it from the line.

The ratio of the secondary current in any transformer to the load component of the primary current is constant and is fixed by the ratio of the turns on the primary and the secondary windings. The two currents are exactly opposite in phase. The total primary current and the secondary current are not exactly opposite in phase, neither is their ratio exactly constant. Both their phase relation and their ratio varies on account of the magnetizing current in the primary and the component current in the primary which is required to supply the core losses.

When the secondary winding is closed through a very low impedance, such as an ammeter or the current coil of a wattmeter, the secondary induced voltage becomes very small and is equal to the impedance drop in the instrument plus the impedance drop in the secondary of the transformer. The mutual flux required to produce this small induced voltage will be correspondingly small and, since it is the mutual flux which determines the magnetizing current and the component current supplying the core losses, these two components of the primary current will be small. Under normal conditions, *i.e.*, with the secondary winding short-circuited through an instrument,

neither of these two components of the primary current should be more than a fraction of a per cent. of the rated current of the transformer. The voltage drop across the primary winding will, of course, be merely the equivalent impedance drop in the transformer plus the impedance drop in the instrument, both referred to the primary winding.

Although the induced voltage in the current transformer and, therefore, the mutual flux are both directly proportional to the secondary current, assuming the impedance of the transformer and the instrument are constant, the small exciting current will not be exactly proportional to or make a constant angle with the induced voltage, since neither component of this current varies as the first power of the mutual flux.

The magnitudes of both components of the exciting current will depend upon the degree of saturation of the iron core of the transformer. For this reason, direct current should not be put through a current transformer unless the precaution is afterward taken to thoroughly demagnetize the core. For the same reason, the secondary winding should not be opened while the primary carries current. Passing either direct current through the windings of a current transformer or opening its secondary circuit while its primary winding carries current will change its ratio of transformation. The winding with the fewer turns is the one placed in the line; therefore, if the secondary winding is opened, the current transformer becomes a step-up transformer and a voltage both dangerous to life and to the insulation of the transformer may be induced in its windings. This voltage is limited by the saturation of the core. It will be very much less than the voltage of the circuit in which the transformer is placed multiplied by ratio of turns. If the secondary in any way should be accidentally opened, the core should be completely demagnetized before putting the transformer back in service. A current transformer should be insulated for the full voltage of the line on which it is to be used and should be operated with its secondary winding and also its case solidly grounded.

On account of the effect of the exciting component of the primary current upon the ratio of the primary and secondary currents and upon the phase relation between them, the exciting currents of current transformers must be made small by

designing such transformers to operate at relatively low flux densities. The windings must also be arranged for minimum leakage since any increase in the leakage reactance will increase the mutual flux and, therefore, both components of the exciting current.

From what precedes, it is obvious that current transformers should be calibrated with the instruments with which they are to be used, as well as at the currents to be measured. For power measurements where accuracy is essential, it is often necessary to apply corrections for the phase displacement between the primary and secondary currents caused by the exciting current.

Fig. 110 will apply to a current transformer if x_2 and r_2

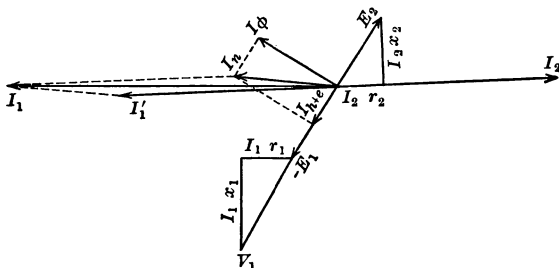

FIG. 110.

are considered to include the reactance and resistance of the instrument with which the transformer is used.

Current transformers are made for two classes of work, namely: for use with instruments, and for operating protective and regulating devices such as automatic oil switches. For the second class of service great accuracy or constancy of transformation ratio with change in load is not required, but great reliability is of prime importance.

Current transformers, in the case of high-voltage power stations, form an extremely important part of the auxiliary apparatus and require no small amount of space. They range in weight from 40 to 50 lb. for very low voltages to as much as 4000 lb. for 110,000 volts, and in height from 6 or 8 in. to 8 ft. and a diameter of 3 ft. A current transformer for a 66,000-volt circuit is shown in Fig. 111.

Potential Transformer.—Potential transformers are used to increase the range of alternating current voltmeters and wattmeters and at the same time to insulate them from the line voltage. They do not differ from ordinary transformers except in detail of design.

The ratio of the terminal voltages of an ordinary transformer does not change by more than a few per cent. from no load to full

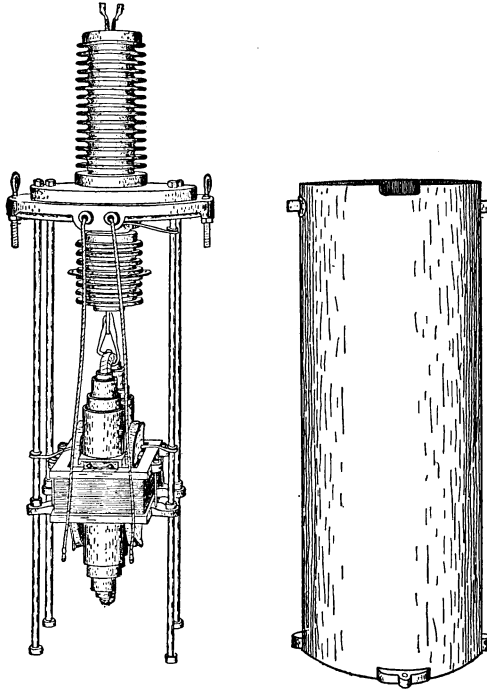

FIG. 111.

load and the voltages would be in opposition if it were not for the resistance and the reactance drops. By designing a potential transformer with low resistance and reactance, the change in phase and in magnitude of the terminal voltages may be made small. The phase relation is of importance only when potential transformers are used in connection with wattmeters. Since the magnetizing current and the current supplying the core losses are important parts of the primary current, these com-

ponent currents should be kept small. The influence of the resistance and the leakage reactance of the windings is far more important in a potential transformer than in a current transformer, since these factors affect both the ratio of transformation and the phase relation between the primary and secondary terminal voltages directly. The exciting current of a properly

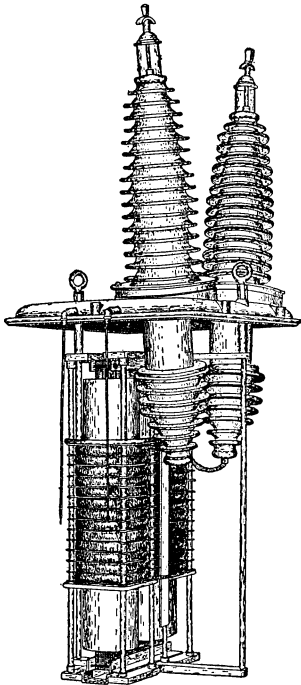

FIG. 112.

designed potential transformer should have relatively little influence on either the ratio of transformation or the phase relation between the terminal voltages. When potential transformers are used for accurate power measurements, correction for the phase displacement between the primary and secondary voltages caused by the resistances and leakage reactances may have to be applied. Potential transformers as well as current transformers should always be calibrated.

The space required for high-voltage potential transformers, and their weights are somewhat greater than the space and weights of current transformers for the same line voltage. A 110,000-volt potential transformer is shown in Fig. 112.

Constant-current Transformer.—

When arc or incandescent lamps are operated in series, as is almost universally done when they are used for street lighting, they must all have the same current rating and must be operated from a circuit which carries a constant current and which varies its voltage with the number of lamps in use. Except in some of the older central stations, where there may still be some Brush arc-light generators, constant-current or "tub" transformers are now almost universally employed for such circuits. Since all modern arc lamps are of the luminous or flame type and require unidirectional current for their operation, the constant-current transformer would be of

little use if it were not for the mercury arc rectifier. The constant-current transformer, however, with a mercury arc rectifier and suitable reactances to smooth out the current wave, forms a very satisfactory source of power for constant-current circuits feeding modern arcs. They are extensively used with rectifiers and form an important part of the auxiliary apparatus of all central stations supplying power for street lighting.

If a transformer of the ordinary type is designed with very high leakage reactance, it will have a very drooping voltage characteristic and it may even be short-circuited without producing excessive current. A core-type transformer which has its primary and secondary windings on opposite sides of a core which is designed to give excessive leakage will have a characteristic of this kind. A transformer which is designed in this way,

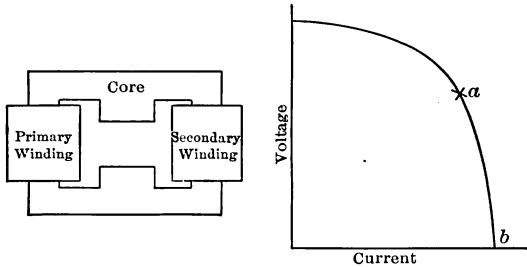

FIG. 113.

if operated on the drooping part of its characteristic, will give a considerable range of voltage at sensibly constant current. The characteristic of a transformer which has excessive magnetic leakage is shown in Fig. 113.

Between *a* and *b* on the characteristic there is a large change in voltage with a comparatively small variation in current. If the leakage reactance can be increased automatically as the current tends to increase, the transformer may be made to regulate for constant current throughout any desired range of load.

The necessary automatic increase in the reactance is obtained in the constant-current transformer by arranging the primary and the secondary windings so that they may move relatively to one another. The increase in the repulsion between the two

windings produced by an increase in the current, causes them to move apart and increase the cross-section of the path for magnetic leakage and thus increase the reactance.

The simple arrangement by which this is usually accomplished is shown in Fig. 114.

CCC is the iron core which should be long and should operate at relatively high density. A and B , respectively, are the primary and secondary windings. The secondary winding, B , is movable and is supported from an arm pivoted at D . A weight W , which is hung from the sector S attached to the

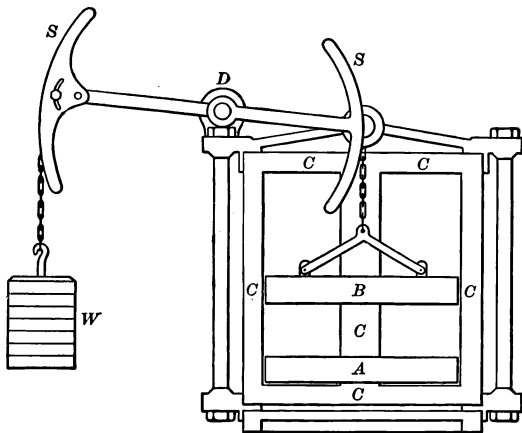

FIG. 114.

swinging arm, partially counterbalances the weight of the secondary winding.

Due to the force of repulsion between the two windings caused by the primary and secondary currents, the winding B will move away from A until this force of repulsion is just equal to the unbalanced weight of the arm and the coil. If the impedance of the external circuit is diminished, the current will increase and the winding B will move farther away from A increasing the reactance and diminishing the current. By properly adjusting the counter-weight, W , and the shape of the sectors and angle at which they are set, the transformer may be made to regulate for very nearly constant current over any desired range of load, provided the core is long enough to allow the windings

to get far enough away from one another at no load, *i.e.*, short-circuit on the secondary. The maximum load is that at which the windings come in contact.

The conditions under which constant-current circuits are

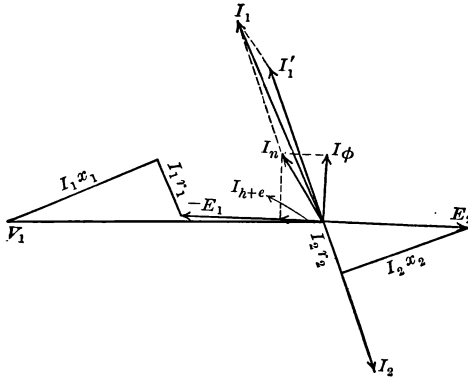

FIG. 115.

operated seldom require constant-current regulation from full load to no load; consequently most constant-current transformers are designed for a limited range of regulation. This range is usually from full load to about one-half or one-quarter load.

Since the secondary current in a properly adjusted constant-

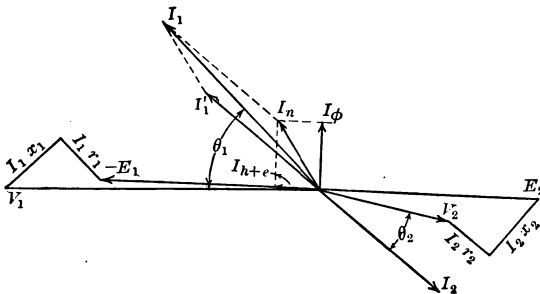

FIG. 116.

current transformer is constant, the load component of the primary current will also be constant. If it were not for the variation in the exciting current, the whole primary current would be constant. Therefore, the primary winding will operate at a constant voltage and very nearly constant current, and

the entire change in input will be caused by a change in the primary power factor. The secondary winding will deliver power at constant current and variable voltage and at a power factor which is determined by the constants of the load.

The method by which a constant-current transformer regulates for constant current should be made clear by inspecting Figs. 115 and 116. Fig. 115 is for no load, *i.e.*, short-circuit; Fig. 116 is for a large inductive load. The entire regulation is due to the change in the leakage-reactance drop with the change in load.

When constant-current transformers are designed for more than 50 lights, the middle point of the secondary circuit feeding the lamps is sometimes looped back to the transformer giving in effect two independent circuits. No change in the trans-

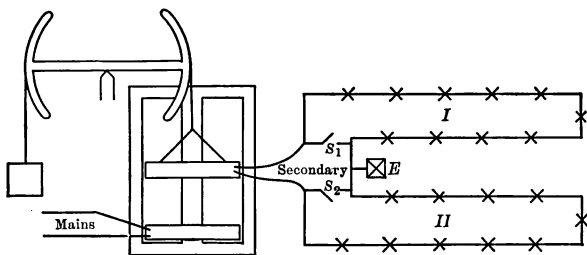

FIG. 117.

former is required for this arrangement of secondary circuit. The connections for the two circuits are shown in Fig. 117.

The two circuits I and II are brought back to the transformer and grounded at E . Either of these two circuits may be short-circuited and cut out by the switches s_1 and s_2 and the remaining circuit operated alone.

A constant-current transformer is started with the secondary winding lifted to its highest position and with the load short-circuited. After the primary circuit has been closed, the short-circuit switch on the load is opened and the secondary winding released and allowed to take up the position corresponding to the load on the transformer.

Constant-current transformers are extensively used with mercury-arc rectifiers to supply arc lights requiring unidirectional current.

Auto-transformer.—In addition to the regular type of transformer in which the primary and secondary windings are entirely independent, there is another type known as the auto-transformer or compensator which has a single continuous winding, a portion of which may be considered to serve both as primary and secondary. The size of the wire used for the continuous winding will not be the same throughout unless the ratio of transformation is such that its two parts carry the equal currents. The arrangement of the auto-transformer should be made clear by Fig. 118.

If used as a step-down transformer, all the turns between *a* and *c* will serve as the primary winding. Some of these, namely, those between *b* and *c*, will also serve as secondary.

If the transformer is used to raise the voltage, all the turns will act as a secondary winding but only those between *b* and *c* will serve as a primary. Some of the turns on an auto-transformer may be considered to serve the double purpose of primary and secondary windings. Since a part of the winding on an auto-transformer serves for both primary and secondary, an auto-transformer will require less material and will therefore be cheaper than an ordinary transformer of the same output and efficiency. The saving, however, is large only when the ratio of transformation is near unity. Since the primary and secondary windings of an auto-transformer are in electrical connection, the use of auto-transformers for high ratios of transformation is limited to those places where electrical connection between the low-voltage winding and a high-potential circuit is not objectionable.

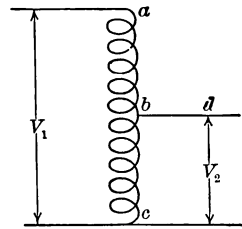

FIG. 118.

Since all the turns on the auto-transformer between *a* and *c* link the same mutual flux, the voltage induced per turn will be the same throughout the winding. Therefore, if N_{ac} and N_{bc} are, respectively, the turns on the winding between *ac* and *bc*, the ratio of transformation will be

$$\frac{N_{ac}}{N_{bc}} = a$$

If the secondary circuit is closed, a current I_{bd} will flow to the load. In the case of the ordinary transformer, this current

would flow in an independent secondary winding having N_{cb} turns and would exert a demagnetizing effect equal to $I_{bd}N_{cb}$ ampere turns. This demagnetizing action would be balanced by an increase in the primary current which would also flow in an independent primary winding having N_{ac} turns. The product of the currents by the number of turns in which they flow would be equal in magnitude and opposite in phase. The resultant effect of the currents in producing the flux would be zero.

In the case of an auto-transformer the secondary turns and a part of the primary turns are combined. These combined turns, *i.e.*, those between b and c , Fig. 118, may be considered to carry the above-mentioned currents as components, but it is simpler and easier to consider the currents in the auto-transformer from the standpoint of Kirchhoff's laws.

Let the order of double subscripts used with a letter representing a current or voltage indicate the direction in which the current or voltage is considered. Double subscripts when attached to N , the number of turns in a winding, or when used with a resistance or reactance merely indicate the limits between which the number of turns, the resistance or the reactance is considered. Their order in this case has no significance whatever.

According to Kirchhoff's laws (Refer to Fig. 118.)

$$I_{bd} = I_{ab} + I_{cb} \quad (74)$$

The current output I_{bd} is the vector sum of the component currents I_{ab} and I_{cb} . The first comes directly from the source of power through the turns N_{ab} without transformation, while the second comes wholly from transformation in the turns N_{cb} . In addition to the currents I_{ab} and I_{cb} in the turns N_{ab} and N_{cb} respectively, all the turns, in the case of the step-down transformer shown in Fig. 118, carry an additional component current, I_n , which is the exciting current for the transformer.

As in the ordinary transformer, the magnetizing effects of the currents I_{ab} and I_{cb} must balance. Hence

$$I_{cb}N_{cb} = I_{ab}N_{ab} \quad (75)$$

$$\begin{aligned} \frac{I_{cb}}{I_{ab}} &= \frac{N_{ab}}{N_{cb}} \\ &= \frac{N_{ca} - N_{cb}}{N_{cb}} = \frac{N_{ca}}{N_{cb}} - 1 = a - 1 \end{aligned} \quad (76)$$

The load currents in the two parts of an auto-transformer are, therefore, in the ratio $(a - 1)$, where a is the ratio of transformation of the auto-transformer as a whole, *i.e.*, between the points ac and cb .

Let E_{ab} , E_{bc} and E_{ac} be the voltages induced by the mutual flux in the turns between ab , bc and ac respectively. Then

$$E_{ab} = E_{ac} - E_{bc}$$

and

$$\frac{E_{ab}}{E_{bc}} = \frac{E_{ac} - E_{bc}}{E_{bc}} = a - 1 \tag{77}$$

Therefore, the ratio of the voltages and the ratio of the load currents in the turns between a and b and between b and c are the same as if the turns N_{ab} and N_{bc} formed the primary and secondary windings of an ordinary transformer having a ratio of transformation of $a - 1$.

In the case of a step-down auto-transformer, the current going to the load may be considered to be made up of two parts: one supplied directly from the line through the coils N_{ab} without transformation, and the other supplied by transformer action in the coils N_{bc} . These two component currents will be in phase with respect to the load and in opposition in so far as their magnetic action on the transformer core is concerned. If the auto-transformer is used to step up the voltage, the voltage on the secondary or load side will be made up of two parts: one due to the transformer action in the coils N_{ab} , and the other the voltage impressed across the primary winding N_{bc} . These two voltages will be very nearly in conjunction with respect to the load. The gain in output of the auto-transformer over the ordinary transformer is due to the fact that only a portion of the power delivered by it is transformed. A portion is always obtained directly from the line without transformation.

If the exciting current taken by an auto-transformer is neglected, the solution of the vector diagram becomes simple.

Consider a step-down auto-transformer having a ratio of transformation equal to a . Since the ratio of the load currents and the ratio of the induced voltages in the coils N_{ab} and N_{bc} , Fig. 118, are the same as they would be in an ordinary transformer with independent primary and secondary windings having a ratio of transformation equal to $a - 1$, the voltage across the coil N_{ab} may be found by considering N_{ab} to be the primary and N_{bc} the secondary of an ordinary transformer having $a - 1$ for a ratio of transformation. The voltage impressed across

N_{ac} , i.e., the real primary voltage of the auto-transformer, will be the vector sum of V_{ab} and V_{bc} .

The vector diagram of an auto-transformer, neglecting the exciting current, is shown in Fig. 119. The regulation is

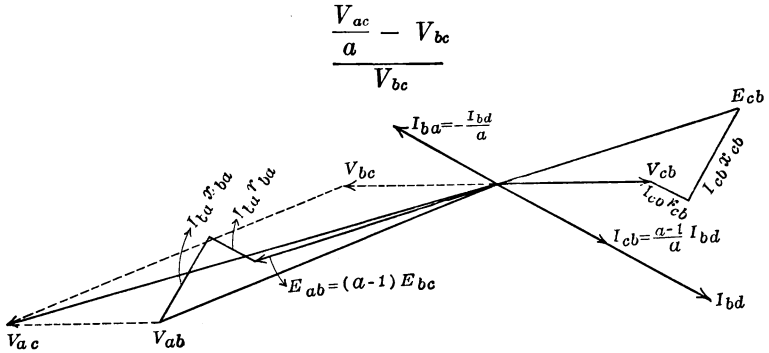

FIG. 119.

In Fig. 119, I_{bd} is the current going to the load. The current in the winding N_{bc} must, of course, be used for finding the impedance drop in N_{bc} . This current is

$$I_{cb} = I_{bd} + I_{ba}$$

or since

$$I_{ba} = -\frac{I_{bd}}{a}$$

$$I_{cb} = I_{bd} - \frac{I_{bd}}{a} = I_{bd} \frac{a-1}{a}$$

The vector diagram of the auto-transformer may be simplified by combining the resistances r_{bc} and r_{ab} into a single equivalent resistance, and the reactances x_{bc} and x_{ab} into an equivalent reactance.

$$r_e = r_{ab} + r_{bc}(a-1)^2$$

and

$$x_e = x_{ab} + x_{bc}(a-1)^2$$

The simplified diagram of an auto-transformer with all vectors referred to the winding N_{ab} is given in Fig. 120.

$$\begin{aligned} V_{ac} &= V_{bc} + V_{ab} \\ &= V_{bc} + (a-1)V_{bc} + I_{ba}(r_e + jx_e) \\ &= aV_{bc} + \frac{I_{bd}}{a}(r_e + jx_e) \end{aligned}$$

The resistance r_e and the reactance x_e may be found by any of the methods used for determining the equivalent resistance and the equivalent reactance of an ordinary transformer, by merely treating N_{ab} and N_{bc} as the primary and the secondary windings, respectively, of an ordinary transformer. The electrical connection between these two coils will not influence the measurements. The core loss may be found by applying the proper voltage across any two terminals.

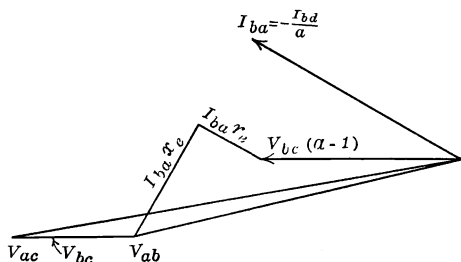

FIG. 120.

Relative Outputs of the Auto-transformer and the Regular Transformer.—Since a portion of the turns of an auto-transformer serve the double function of primary and secondary windings, less copper will be required for an auto-transformer than for one of the ordinary type having the same rating and efficiency. All of the power delivered on the secondary side of an ordinary transformer is obtained from transformation. Only a portion of the power delivered by an auto-transformer is the result of transformer action. The remaining portion comes directly from the line. Therefore, on the basis of the same losses and the same amount of material the auto-transformer will have the greater output.

Consider the step-down transformer shown in Fig. 118. The current I_{bd} is made up of two parts: one, I_{cb} , which is produced by transformer action, and the other, I_{ab} , which comes from the line without transformation through the portion of the winding ab . The part of the current output obtained by transformer action is

$$I_{cb} = I_{bd} \frac{a-1}{a}$$

In the case of an ordinary transformer all of the power delivered is the result of transformer action.

The output of the auto-transformer as compared with the output of the ordinary transformer with the same amount of material will be the ratio of the total output of the auto-transformer to that portion of its output which is obtained as a result of transformer action. Therefore,

$$\frac{\text{Output of auto-transformer}}{\text{Output of ordinary transformer}} = \frac{1}{\frac{a-1}{a}} = \frac{a}{a-1}$$

If the auto-transformer steps up the voltage, a similar reasoning applied to the voltages will give the same result.

All of the preceding discussion in regard to relative outputs of the two types of transformers assumes the same mean length of turn on all windings and, therefore, the expression obtained will, in most cases, only be approximately correct when applied to transformers of standard design.

The core losses of the auto-transformer and of the ordinary transformer will be the same, provided the dimensions of the iron cores and the flux densities are the same for both. Therefore, for the same voltage both types of transformers must have the same number of turns for their primary and their secondary windings. The only difference is that some of the turns on the auto-transformer serve for both the primary and the secondary. Merely rewinding a transformer for an auto-transformer should not affect its core loss.

For the same copper loss, the output of the auto-transformer will be the greater. Since its output is greater, its efficiency will also be greater. It follows that, for the same efficiency and output, less copper and less iron will be required for an auto-transformer than for an ordinary transformer. The auto-transformer will, therefore, be the cheaper of the two types.

Since reactances vary as the square of the numbers of turns on the coils, the ratio of the equivalent reactances of the two types of transformers will be

$$\begin{aligned} \frac{x_e \text{ for auto-transformer}}{x_e \text{ for ordinary transformer}} &= \frac{N_{ab}^2 + N_{bc}^2(a-1)^2}{N_{ac}^2 + N_{bc}^2 a^2} \\ &= \frac{N_{bc}^2(a-1)^2 + N_{bc}^2(a-1)^2}{N_{bc}^2 a^2 + N_{bc}^2 a^2} \\ &= \left(\frac{a-1}{a}\right)^2 \end{aligned}$$

This ratio will not necessarily hold when the change from regular to auto-transformer is made by merely reconnecting the windings.

The increase in the output of the auto-transformer for the same total heating is entirely due to the decrease in the copper loss. The equivalent resistance, therefore, of the auto- and ordinary transformers must, consequently, be in the inverse ratio of the square of their respective relative outputs. Therefore,

$$\frac{r_e \text{ auto-transformer}}{r_e \text{ ordinary transformer}} = \left(\frac{a - 1}{a}\right)^2$$

Since the ratio of the equivalent resistances of the ordinary and auto-transformers, and also the ratio between the equivalent reactances, decreases more rapidly than the ratio of the outputs increases, the regulation of the auto-transformer will be better than the regulation of an ordinary transformer with the same amount of material and same mean length of turn.

The relative outputs, resistances and reactances, and the relative impedance drops for the auto- and the ordinary transformers are given in Table XV. This table is based upon the same amount of material, the same losses and the same mean length of turn for the two types of transformers. All ratios are for the auto- to the ordinary transformer.

TABLE XV

Ratio of transformation	Relative outputs	Ratio of equivalent resistances	Ratio of equivalent reactance	Ratio of impedance drops
10 : 1	$1\frac{9}{9}$	$8\frac{1}{100}$	$8\frac{1}{100}$	$\frac{9}{10}$
5 : 1	$\frac{5}{4}$	$1\frac{6}{25}$	$1\frac{6}{25}$	$\frac{4}{5}$
3 : 1	$\frac{3}{2}$	$\frac{4}{9}$	$\frac{4}{9}$	$\frac{2}{3}$
2 : 1	$\frac{2}{1}$	$\frac{1}{4}$	$\frac{1}{4}$	$\frac{1}{2}$
1 : 1	∞	0	0	0

Briefly, the advantages of the auto-transformer are lower cost and better regulation and efficiency for the same amount of material. Its disadvantage is that its low-potential winding is in electrical connection with and forms part of the high-potential winding. It will be seen from Table XV that the advantages of the auto-transformer decrease very rapidly as the ratio of trans-

formation is increased and for all practical purposes disappear for ratios above 5.

One of the principal uses of auto-transformers is for obtaining reduced voltage for starting polyphase induction motors which have squirrel-cage armatures. Auto-transformers are also used in connection with single-phase locomotives for stepping down the line voltage to a value suitable for the motors. In this connection, although the ratio of transformation may be fairly high, the electrical connection between the primary and secondary windings is not objectionable, since the secondary winding is always grounded through the trucks of the locomotive. Another very important use of auto-transformers is to step up the voltage of generators wound for about 6600 volts in the ratio of 2 to 1. The difficulty and expense of providing proper insulation for high-voltage generators increases rapidly as the voltage is raised, and it is often cheaper and in some other respects better to wind generators for about 6600 volts and then step up the voltage for transmission by means of transformers. When, as in most cities, the trunk lines for distribution are operated at about 13,200 volts, the auto-transformer is generally used for stepping up the voltage of the generators to that required for transmission. Auto-transformers are particularly well adapted for this purpose as the ratio of transformation required is 2 to 1, a ratio at which an auto-transformer gives a large output for a given amount of material. The cost of generators wound for about 6600 volts together with auto-transformers to double their voltage is often less than a generator wound directly for the required voltage.

Induction Regulator.—When several circuits are fed from one central station or from a single alternator, it is often necessary to have some means of regulating the voltages of the different circuits independently of one another. The induction regulator is commonly used for this purpose.

The induction regulator is essentially a step-down transformer with one of its windings mounted in such a way that it may be rotated into different positions with respect to the other. When the axes of the two windings are coincident, the maximum voltage will be induced in the secondary. When they are at right angles the secondary voltage will be zero. Any intermediate voltage may be obtained. The primary winding of the regulator is

placed across the line the voltage of which is to be regulated. The secondary is placed in series with the line beyond the point to which the primary is connected. The regulator will then either add to the voltage of the line or subtract from it according to the relative positions of its two windings. A diagram of the connections of a single-phase induction regulator is shown in Fig. 121. *PP* and *SS* are the primary and secondary windings respectively. *CC* is a short-circuited winding. The secondary winding, *SS*, may be placed in different positions with respect to the primary by rotating the core carrying the winding about its axis *A*.

When the axes of the two windings of a single-phase induction regulator are at right angles, there can be no mutual induction between them. Under this condition the secondary would act

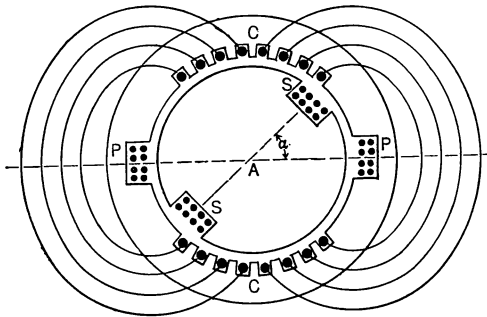

FIG. 121.

like an impedance in series with the line. To prevent this, it is necessary to provide the single-phase regulator with a short-circuited winding on the core which carries the primary with its axis placed at right angles to the axis of that winding. When the primary and secondary windings are at right angles, this short-circuited or compensating winding will act, with respect to the secondary of the regulator, like the secondary of a short-circuited transformer and will neutralize the reactance of the secondary winding of the regulator. Under this condition, the only voltage drop across the secondary of the regulator will be the equivalent resistance and the equivalent leakage-reactance drops of the secondary and compensating windings.

The single-phase induction regulator is essentially a single-phase induction motor with a wound rotor and with a short-

circuiting winding placed on the stator at right angles to the regular primary winding. A single-phase induction regulator is shown in Fig. 122.

The polyphase regulator is similar in principle to the single-phase regulator. It is a polyphase induction motor which has its armature blocked but capable of being placed in different positions with respect to its field winding. The polyphase induction regulator requires no compensating winding. The

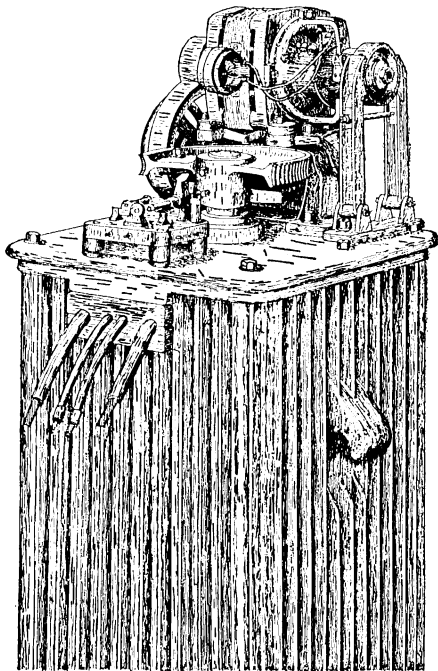

FIG. 122.

voltages given by its secondary windings are constant, but their phase relation with respect to the line voltage may be varied by moving the secondary winding with respect to the primary. The secondary voltage may either add or subtract directly from the line voltage or combine with it at any intermediate phase. The action of a polyphase induction regulator depends upon the revolving magnetic field of a polyphase induction motor and will best be understood after taking up that motor.

CHAPTER XIX

TRANSFORMERS WITH INDEPENDENTLY LOADED SECONDARIES; PARALLEL OPERATION OF SINGLE-PHASE TRANSFORMERS

Transformers with Independently Loaded Secondaries.—In most cases when power is supplied for incandescent lighting, it is supplied by the three-wire system. A three-wire system may be obtained by using two transformers with their primaries in parallel and their secondaries in series, but a single transformer will serve the purpose equally well and, moreover, it will cost less than two smaller transformers of the same total capacity.

Most commercial transformers have two primary and two secondary windings which are connected in series or in parallel according to the voltage required. If the secondaries are connected in series, they may be used to feed a three-wire circuit by connecting the neutral of the circuit to the common connection between the two secondary windings.

If the circuit is unbalanced, the secondary windings will carry currents which are independent of each other. They may be of entirely different magnitudes and power factors. The effect is the same as if there were no electrical connection between the two windings and the windings were independently loaded. If the transformer is to feed a three-wire system, the two windings must, necessarily, be for the same voltage. A transformer may have any number of independent secondary windings all of which may be independently loaded.

Whatever be the arrangement of the secondary windings, or the load carried by them, the primary current must always contain a load component which just balances the combined demagnetizing action of all the secondary currents. This primary load current must, therefore, be equal to the vector sum of all the secondary currents referred to the primary side. The ratios of transformation between the secondaries and the primary winding need not be the same.

Fig. 123 shows the vector diagram of a transformer with

two secondaries each carrying a different load. All vectors are referred to the primary winding. Single and double primes are used where necessary to distinguish the currents, voltages, etc., of the two secondary windings. On this diagram, the load component of the primary current is I_1 , and not I'_1 as on all preceding diagrams of the transformer. I'_1 represents the component of the primary current which is due to the secondary current I'_2 . I_0 represents the total primary current and is equal to the vector sum of I_1 and I_n .

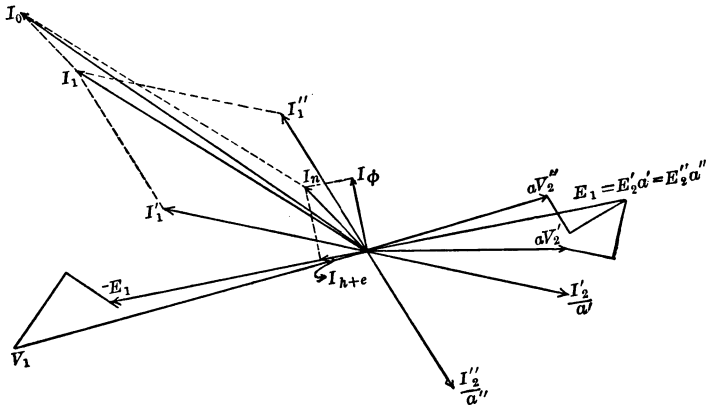

FIG. 123.

The solution of the diagram is difficult and usually is possible only by making a series of approximations. The exciting current I_n will be neglected and the leakage reactances will be assumed to be constant. This latter assumption may be deviated from to some extent if the unbalancing is great. All vectors will be referred to the induced voltage E_1 as an axis. Let R and X with the proper primes be the constants of the two secondary loads and let θ'_2 and θ''_2 be the angles of lag of the secondary currents behind their induced voltages.

$$\begin{aligned} \alpha' E'_2 &= \alpha'' E''_2 = E_1 \\ \alpha' E'_2 &= \alpha' I'_2 [(r'_2 + R') + j(x'_2 + X')] \\ \alpha'' E''_2 &= \alpha'' I''_2 [(r''_2 + R'') + j(x''_2 + X'')] \\ \cos \theta'_2 &= \frac{r'_2 + R'}{\sqrt{(r'_2 + R')^2 + (x'_2 + X')^2}} \end{aligned}$$

$$\cos \theta''_2 = \frac{r''_2 + R''}{\sqrt{(r''_2 + R'')^2 + (x''_2 + X'')^2}}$$

$$\sin \theta'_2 = \frac{x'_2 + X'}{\sqrt{(r'_2 + R')^2 + (x'_2 + X')^2}}$$

$$\sin \theta''_2 = \frac{x''_2 + X''}{\sqrt{(r''_2 + R'')^2 + (x''_2 + X'')^2}}$$

$$I_1 = - \left[\frac{I'_2}{a'} + \frac{I''_2}{a''} \right] \text{vectorially}$$

$$= - \left[\frac{1}{a'} (I'_2 \cos \theta'_2 - jI'_2 \sin \theta'_2) + \frac{1}{a''} (I''_2 \cos \theta''_2 - jI''_2 \sin \theta''_2) \right]$$

$$= A + jB$$

$$V_1 = - E_1 + (A + jB)(r_1 + jx_1)$$

$$V'_2 = E'_2 - I'_2(\cos \theta'_2 - j \sin \theta'_2)(r'_2 + jx'_2)$$

$$V''_2 = E''_2 - I''_2(\cos \theta''_2 - j \sin \theta''_2)(r''_2 + jx''_2)$$

Parallel Operation of Single-phase Transformers.—The conditions which must be fulfilled for the satisfactory parallel operation of transformers are:

1. The secondary currents should all be zero when the load on the system is zero.
2. The secondary current carried by each transformer should be proportional to its rating.
3. The secondary currents should be in phase with each other and consequently in phase with the current taken by the load on the system.

Whether the conditions for the parallel operation of transformers are fulfilled will depend upon the ratios of transformation and the constants of the transformers. Transformers cannot be paralleled indiscriminately even though their ratios of transformation are the same.

The same voltage is impressed on the primaries of all transformers operating in parallel and, therefore, all primary terminal voltages must be exactly equal and exactly in phase. Similarly, since all the secondaries are connected together, all of the secondary terminal voltages must be equal and in phase. If the ratios of transformation are equal, the primary voltages referred to the secondary side will be equal and in phase, and if the exciting currents are neglected, the equivalent impedance drops of all transformers will be equal and in phase since they must form the closing side of a voltage triangle which has for its other two

sides the common impressed primary voltage referred to the secondary windings and the common secondary terminal voltage.

Transformers having the Same Ratio of Transformation.—The current a transformer will deliver when in parallel with others depends merely upon its equivalent impedance and not upon the way in which the resistance and the reactance is distributed between its primary and secondary windings.

Unless the ratios of the primary to the secondary resistances of all the transformers are equal and the ratios of the primary to the secondary reactances are also equal, the induced voltages will neither be equal nor in phase. Fig. 124 shows the conditions for two transformers when these ratios are not equal. The drops are exaggerated to make the diagram clearer.

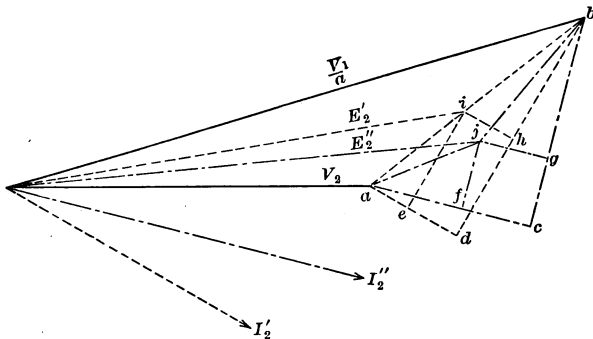

FIG. 124.

The two equivalent impedance triangles are *abc* and *abd*. Each of these is made up of two parts, namely: the drop in the secondary winding, and the drop in the primary winding referred to the secondary.

aie and *ajf* are the two impedance triangles for the secondaries and *ibh* and *jbg* are similar triangles for the primaries referred to the secondaries. *i* and *j*, *i.e.*, E'_2 and E''_2 , cannot coincide unless

$$\frac{r'_1}{r'_2} = \frac{r''_1}{r''_2} \text{ and } \frac{x'_1}{x'_2} = \frac{x''_1}{x''_2}$$

r'_1 and r'_2 are, respectively, the primary and the secondary resistances of one transformer and r''_1 and r''_2 are the corresponding

resistances of the other. The x 's are the reactances. Unless E'_2 and E''_2 are equal and in phase, there will be a resultant voltage acting in the series circuit consisting of the two secondary windings. This resultant voltage, however, will not cause any additional current since it is balanced by the impedance drops already existing in the two secondary windings. For a similar reason, the resultant voltage due to the difference between the two primary induced voltages will be balanced by the impedance drops in the two primary windings. Consider, for example, the secondaries. The two secondary voltages, V'_2 and V''_2 , which must be equal, are each respectively equal to

$$E'_2 - I'_2 z'_2 \text{ and } E''_2 - I''_2 z''_2$$

$$E'_2 - I'_2 z'_2 = E''_2 - I''_2 z''_2$$

and

$$E'_2 - E''_2 = I'_2 z'_2 - I''_2 z''_2$$

Therefore, the difference between the two secondary induced voltages which act in the circuit consisting of the two secondary windings in series is balanced by the impedance drops due to the existing secondary currents I'_2 and I''_2 . If the load is zero I'_2 and I''_2 will be equal. The difference between the two primary induced voltages is similarly balanced. It follows from this that the current output of any transformer which is in parallel with others having the same ratio of transformation is not affected by the distribution of the resistance and the reactance between the primary and the secondary windings. It depends merely upon the equivalent impedance.

Let the secondary currents delivered by any number of transformers which are connected in parallel be I'_2, I''_2, I'''_2 , etc., and let the equivalent impedances and the equivalent admittances all referred to the secondary windings be, respectively, z'_e, z''_e, z'''_e , etc., and y'_e, y''_e, y'''_e , etc. Then since the impedance drops must all be equal,

$$I'_2 z'_e = I''_2 z''_e = I'''_2 z'''_e, \text{ etc.}$$

and

$$\begin{aligned} I'_2 : I''_2 : I'''_2, \text{ etc.} &= \frac{1}{z'_e} : \frac{1}{z''_e} : \frac{1}{z'''_e}, \text{ etc.} \\ &= y'_e : y''_e : y'''_e, \text{ etc.} \end{aligned}$$

The currents delivered by the transformers to the load are, therefore, inversely proportional to their equivalent impedances or directly proportional to their equivalent admittances. The total current, I_o , delivered by the system will be equal to the vector sum of the component currents delivered by the separate transformers.

$$I_o = I'_2 + I''_2 + I'''_2, \text{ etc.}$$

A vector diagram for two transformers having equal ratios of transformation is shown in Fig. 125. The no-load current is neglected.

The impedances on the diagram are in the ratio of 2 : 1. Therefore,

$$\frac{I'_2}{I''_2} = \frac{z''_e}{z'_e} = \frac{y'_e}{y''_e} = 2$$

If the two impedances were equal, the currents would also be equal. The currents can be in phase only when the ratio of the

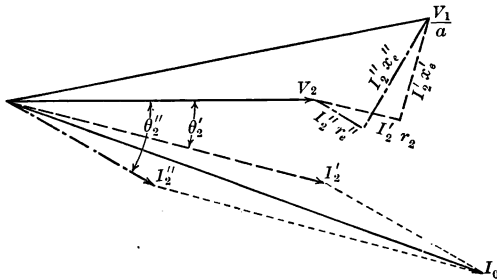

FIG. 125.

equivalent resistance of each transformer to its equivalent reactance is the same for both transformers.

The proper division of load between any number of transformers which operate in parallel is that which causes all the transformers to reach their maximum safe temperatures at the same time. This does not necessarily mean that the current supplied by each will be in proportion to the manufacturer's rating, since this rating may be more conservative for some than for others. The maximum safe temperature of different types may not be the same.

Transformers having the same ratio of transformation may be represented by the equivalent circuit shown in Fig. 126.

The division of load between any number of transformers which have equal ratios of transformation may be found in the following manner: Referring to Fig. 126, let v be the voltage across the parallel admittances, $y'_e = g'_e - jb'_e$, $y''_e = g''_e - jb''_e$, $y'''_e = g'''_e - jb'''_e$, etc. These represent the equivalent ad-

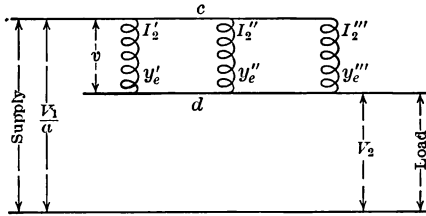

FIG. 126.

mittances of the transformers. The resultant admittance between the points c and d of the equivalent circuit is

$$y_o = g_o - jb_o = \Sigma g_e - j \Sigma b_e$$

where Σg_e and Σb_e are, respectively, $g'_e + g''_e + g'''_e$, etc., and $b'_e + b''_e + b'''_e$, etc.

$$\begin{aligned} I'_2 &= v y'_e = v(g'_e - j b'_e) \\ I''_2 &= v y''_e = v(g''_e - j b''_e) \\ I'''_2 &= v y'''_e = v(g'''_e - j b'''_e) \\ &\text{etc.} \qquad \qquad \text{etc.} \end{aligned}$$

Since the total load current

$$\begin{aligned} I_o &= I'_2 + I''_2 + I'''_2 + \text{etc.} \\ &= v y'_e + v y''_e + v y'''_e + \text{etc.} = v y_o \\ v &= \frac{I_o}{y_o} \\ I'_2 &= v y'_e = \frac{I_o}{y_o} y'_e \\ I''_2 &= \frac{I_o}{y_o} y''_e \\ I'''_2 &= \frac{I_o}{y_o} y'''_e \\ &\text{etc.} \qquad \text{etc.} \end{aligned}$$

If only the numerical values of the currents are desired, the y_e 's should be expressed numerically.

It should be noticed that the distribution of the load between transformers with equal ratios of transformation is independent of the load on the system or its power factor.

The equivalent conductance and the equivalent susceptance of a transformer may be obtained from the power, current and voltage measured with the transformer short-circuited. Let the power input, the impressed voltage and the current be, respectively, P , V , and I . Then

$$y_e = \frac{I}{V}$$

$$g_e = \frac{P}{V^2}$$

$$b_e = \sqrt{y_e^2 - g_e^2}$$

All three constants will be referred to the side of the transformer to which I and V are referred. If the equivalent resistance and equivalent reactance are known, the equivalent conductance and equivalent susceptance may be calculated from them.

Transformers having Different Ratios of Transformation.—Transformers of different design but having the same nominal

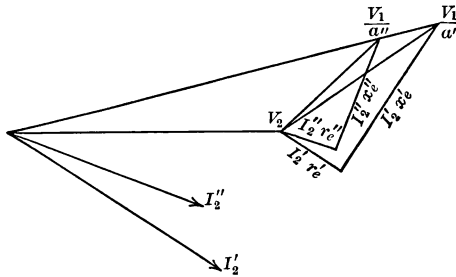

FIG. 127.

ratios of transformation may have actual ratios of transformation which differ slightly from each other. Differences of this kind are most likely to occur in transformers having ratios of transformation which are not whole numbers, since in such cases it may be impossible to make the ratio of the primary to the secondary turns exactly the same as the desired ratio of transformation.

The vector relations which exist when two transformers having different ratios of transformation are put in parallel are shown in Fig. 127.

Let a' , a'' , a''' , etc., be the ratios of transformation of any number of transformers which are in parallel. Then,

$$\begin{aligned} I'_2 z'_e &= \frac{I'_2}{y'_e} = \frac{V_1}{a'} - V_2 \\ I''_2 z''_e &= \frac{I''_2}{y''_e} = \frac{V_1}{a''} - V_2 \\ I'''_2 z'''_e &= \frac{I'''_2}{y'''_e} = \frac{V_1}{a'''} - V_2 \\ &\text{etc.} \quad \text{etc.} \end{aligned}$$

Solving for the currents gives

$$\begin{aligned} I'_2 &= \frac{V_1}{a'} y'_e - V_2 y'_e & (78) \\ I''_2 &= \frac{V_1}{a''} y''_e - V_2 y''_e \\ I'''_2 &= \frac{V_1}{a'''} y'''_e - V_2 y'''_e \\ &\text{etc.} \quad \text{etc.} \end{aligned}$$

Therefore, since the total current, I_o , delivered by the system is equal to the vector sum of the component currents delivered by the separate transformers,

$$\begin{aligned} I_o &= \Sigma \frac{V_1}{a} y_e - \Sigma V_2 y_e \\ &= V_1 \Sigma \frac{y_e}{a} - V_2 y_o & (79) \end{aligned}$$

Solving equation (79) for V_1 gives

$$V_1 = \frac{I_o + V_2 y_o}{\Sigma \frac{y_e}{a}} \quad (80)$$

Substituting V_1 from equation (80) in equation (78) gives

$$\begin{aligned} I'_2 &= \frac{y'_e}{a'} \frac{I_o + V_2 y_o}{\Sigma \frac{y_e}{a}} - V_2 y'_e \\ &= \frac{y'_e I_o}{a' \Sigma \frac{y_e}{a}} + \frac{y'_e V_2}{a'} \left\{ \frac{y_o}{\Sigma \frac{y_e}{a}} - a' \right\} & (81) \end{aligned}$$

This last expression shows that if the ratios of transformation of the transformers are not the same, the current output of any transformer will consist of two components: one dependent upon the load, and the other nearly independent of the load. If the ratios of transformation of all the transformers are equal, equation (81) reduces to

$$I'_2 = y'_e \frac{I_o}{y_o} \quad (82)$$

which is the same as the expression that has already been deduced for transformers having equal ratios of transformation. The current carried by transformer No. 1, in virtue of the unequal ratios of transformation, will be the difference between equations (81) and (82). This difference is

$$\frac{y'_e}{a'} \left\{ \frac{I_o}{y_o} + V_2 \right\} \left\{ \frac{y_o}{\sum \frac{y_e}{a}} - a' \right\}$$

It should be noted that the division of load between transformers which have dissimilar ratios of transformation depends upon the load carried by the system.

From what precedes, it should be clear that transformers which are to be operated in parallel should have:

- (a) Equal voltage ratings.
- (b) Equal ratios of transformation.
- (c) Equivalent impedances which are inversely proportional to their current ratings.
- (d) Ratios of equivalent resistance to equivalent reactance which are equal.

These four conditions are stated in the order of their relative importance.

That the transformers should have the same voltage rating needs no explanation. If their voltage ratings are not the same, some will be operating on a higher voltage than that for which they are designed, and some on a lower.

If the ratios of transformation are not the same, there will be currents in the transformers, in addition to the exciting currents, when the load on the system is zero. The magnitude of these currents will depend upon the differences between the ratios of

transformation, and they cannot be eliminated without redesigning the transformers.

If the impedances are not inversely proportional to the current outputs which produce the maximum safe temperature rises in the transformers, the transformers will not divide the load properly and some will become overheated while others are below their safe temperatures, unless the system is operated at less than its total rated capacity.

If the ratios of equivalent resistance to equivalent reactance are not the same for all of the transformers, the currents delivered by them will not be in phase with each other or with the load current and the transformers will be carrying kilowatt loads which are not proportional to their current loads. As a result, the copper loss for a given load on the system in all of the transformers and in the system as a whole will be greater than it would be if all of the currents were in phase. In other words, the maximum safe kilowatt output of the system will be diminished.

The last two faults, *i.e.*, impedances not in the proper ratio and unequal ratios of resistance to reactance, may be corrected by inserting the proper amount of resistance, or reactance or both, on either the primary or the secondary sides of the transformers.

CHAPTER XX

TRANSFORMER CONNECTIONS FOR THREE-PHASE CIRCUITS USING THREE TRANSFORMERS; THREE-PHASE TRANSFORMATION WITH TWO TRANSFORMERS; THREE- TO FOUR-PHASE TRANSFORMATION AND VICE VERSA; THREE- TO SIX-PHASE TRANSFORMATION; TWO- OR FOUR-PHASE TO SIX-PHASE TRANSFORMATION; THREE- TO TWELVE-PHASE TRANSFORMATION

Transformer Connections for Three-phase Circuits using Three Transformers.— *Δ and Y Connections.*—When three single-phase transformers are used in connection with three-phase circuits, they may be grouped in any one of the following ways:

1. Primaries in Δ , secondaries in Δ .
2. Primaries in Y , secondaries in Y .
3. Primaries in Δ , secondaries in Y .
4. Primaries in Y , secondaries in Δ .

Any one of these arrangements is symmetrical and will, therefore, give balanced secondary voltages on balanced loads, provided the primary impressed voltages are balanced.

If the transformers are connected with their primaries in Δ and their secondaries in Y , any unbalanced Y - or Δ -connected load may be applied to the secondaries without unbalancing the secondary voltages more than would be accounted for by the differences in the small impedance drops in the transformers. This is obvious since each primary may receive power directly from the line. When the transformers are connected in Y - Y or in Y - Δ , an unbalanced Δ -connected load may be carried without any serious unbalancing of the secondary voltages. Any unbalanced three-phase Δ -connected load, *i.e.*, a load without a neutral connection, may be resolved in to two balanced three-phase loads of opposite phase rotation. (See Principles of Alternating Currents, page 337, R. R. Lawrence.) Each of these balanced loads alone will not produce unbalanced secondary voltages, but together they may cause slight unbalancing of the

secondary voltages due to the way the two groups of impedance drops combine.

If a single-phase load is applied between the line and neutral of a group of transformers which are connected in double Y and which have no neutral connection on their primary side, only a small current can be obtained even if the impedance of the load be reduced to zero. All of the current on the primary side

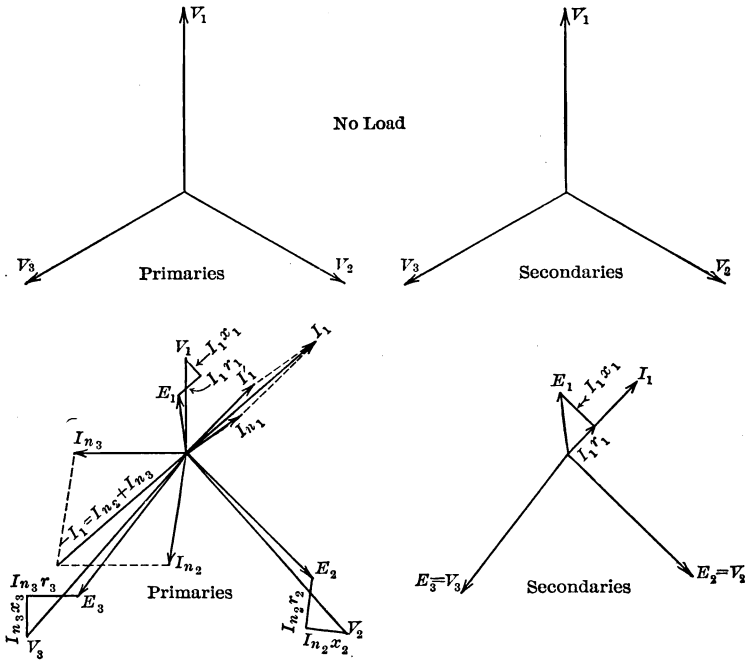

FIG. 128.

of the loaded transformer must come through the primaries of the other two transformers which are on open circuit. Since these transformers are on open circuit, all of the current on their primary sides will be exciting current. It follows, therefore, that the only current that can be obtained from the loaded transformer is a current which is equal, assuming a ratio of transformation of 1, to the vector sum of the exciting currents of the other two transformers. If the impedance of the load be reduced to short-circuit, the only voltage across the primary of the loaded

transformer will be the equivalent impedance drop in that transformer for a current which is much smaller than full-load current. As a result, the neutral point of the transformers on their primary side will shift until it almost coincides with the line to which the loaded transformer is connected. This puts the other two transformers very nearly across line voltage or across a voltage which is very nearly $\sqrt{3}$ times the voltage for which they are designed. This, of course, will very much increase their exciting currents, but even a considerable increase in the exciting currents will allow only a small percentage of full-load current to flow in the loaded transformer. Even a slight unbalancing of a *Y*-connected load will produce a bad unbalancing of the secondary *Y* phase voltages. If the normal exciting currents of three transformers which are connected in *Y* on both their primary and their secondary sides are unequal, the secondary voltages to neutral will be unbalanced at no load as well as under load. If the secondaries are in delta, a small current will circulate in the closed delta. This will act as a magnetizing current and will very nearly restore the balance of the voltages.

The effect of a single-phase load applied to one secondary of a double-*Y*-connected group of transformers, which have no primary neutral connection, is shown in Fig. 128. In order to make the diagram clearer, voltage drops are used on the primary and the secondary sides. This makes corresponding vectors for currents and voltages on the diagrams for the primary and the secondary sides in phase. The subscripts 1, 2 and 3 indicate the

TABLE XVI

Connection		Primary voltage		Secondary voltage	
Primary	Secondary	Between lines	To neutral	Between lines	To neutral
Δ	Δ	1	$\frac{1}{a}$	
Δ	<i>Y</i>	1	$\frac{\sqrt{3}}{a}$	$\frac{1}{a}$
<i>Y</i>	<i>Y</i>	1	$\frac{1}{\sqrt{3}}$	$\frac{1}{a}$	$\frac{1}{a\sqrt{3}}$
<i>Y</i>	Δ	1	$\frac{1}{\sqrt{3}}$	$\frac{1}{a\sqrt{3}}$	

phases. A current vector with a prime represents a primary load component. I'_1 on the left-hand side of the figure is the load component of the primary current for phase 1. I_1 on the right-hand side of the figure is the corresponding secondary current of phase 1.

Table XVI shows the voltage which will be given by the different three-phase transformer connections indicated on page 252.

The principal advantages of the different connections given in Table XVI are:

$\Delta\Delta$. If one transformer is damaged, the system may still be operated at about 58 per cent. of its normal capacity with the remaining two transformers connected in open Δ or V .

ΔY . This gives a higher secondary line voltage for transmission purposes than the other connections without increasing the strain on the insulation of the transformers.

YY . This permits grounding the neutral points of both the primary and the secondary three-phase circuits.

$Y\Delta$. This permits the primary neutral to be grounded. If the $Y - \Delta$ connection is used for transmission purposes, the secondaries may be reconnected in Y if at any time it becomes desirable to raise the transmission voltage in order to increase the capacity of the line.

Y connection of secondaries permits the use of a four-wire distributing system. This is sometimes desirable for lighting.

Method of Testing for Proper Connections.—When three single-phase transformers are to be connected in three-phase, their primary windings may be connected at random since the transformers have entirely independent magnetic circuits and the phase relations between their voltages depend merely upon the way in which they are connected together and to the line. After the primary windings have once been connected, the secondary voltages are fixed. The proper connections for the secondaries must, therefore, be tested out with a voltmeter or by other means.

To connect the secondary windings in Y , connect one terminal of each of two secondaries together and then put a voltmeter across the remaining two free terminals. The voltage across these will either be equal to the voltage of one secondary or to $\sqrt{3}$ times that voltage. It should be $\sqrt{3}$ times that voltage.

If it is not, reverse the connections of either of the two secondaries. When the two secondaries have been connected properly, connect one end of the remaining secondary to the common junction of the other two. The voltage between the free terminal of this last secondary and the free terminal of either of the other two should be $\sqrt{3}$ times the voltage of one secondary. If it is not, reverse the connections of the last secondary.

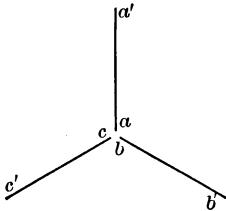

FIG. 129.

The method of testing for the proper connections for putting the secondaries in Δ is similar to the method of testing for putting them in Y . For the Δ connection, connect one end of each of two secondaries together.

The voltage across the free ends should be the same as the voltage of one secondary. If it is not, reverse one of the secondaries. Then connect one end of the remaining secondary to one of the free ends of the other two. The voltage across the remaining gap will be either zero or twice the voltage of one winding.¹ If it is double the voltage, reverse the connections. When it is zero, the remaining gap may be closed and the secondaries will be in Δ . If this gap is closed when the last secondary is connected reversed, the transformers will be virtually short-circuited. Twice the voltage of one winding will act on an impedance which is equal to three times the impedance of a single winding. The current under this condition will be $\frac{2}{3}$ what would flow if a single transformer were short-circuited.

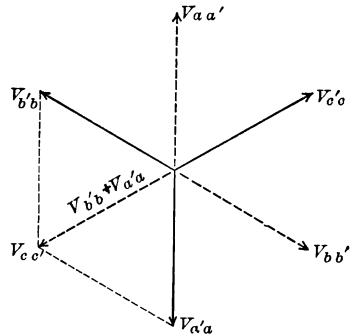

FIG. 130.

Let Fig. 129 represent the secondary windings and also a vector diagram of the secondary voltages.

If a and b are connected together, the voltage across the free ends or across $a'b'$ will be $V_{a'a} + V_{bb'}$. This voltage will be

¹ This assumes there are no third harmonics in the secondary voltages (see page 278).

equal to either $V_{a'a}$ or $V_{b'b}$ multiplied by $\sqrt{3}$ and will lag behind the voltage $V_{bb'}$ by 30 degrees. This is the correct connection of the windings aa' and bb' for Y . If b' is connected to a , the voltage across the free ends or across $a'b$ will be $V_{a'a} + V_{b'b}$. This will be equal to either $V_{aa'}$ or $V_{bb'}$, and will lead $V_{aa'}$ by 120 degrees. This is the correct connection for Δ . The third winding should have c' connected to b of the second if Δ connection is desired. The vector diagram for Δ connection is shown in Fig. 130. The connections are a to b' , b to c' and c to a' .

The vector sum of the three voltages $V_{b'b}$, $V_{c'c}$ and $V_{a'a}$ which act around the closed Δ is zero. If c is connected to b the resultant voltage in the three windings will be $(V_{b'b} + V_{a'a}) + V_{cc'} = 2V_{cc'}$.

Three-phase Transformation with Two Transformers.—

Three-phase transformation may be obtained with only two single-phase transformers by connecting them either in open delta or V or in T . Both of these connections are unsymmetrical and will, therefore, give slightly unbalanced voltages under load. The amount of this unbalancing is, however, small under ordinary conditions, especially with T connection.

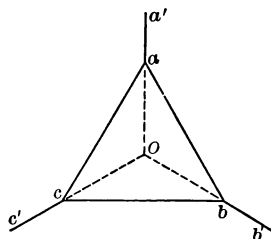

FIG. 131.

Open-delta Connection.—The open-delta or V connection is the same as the delta connection with one transformer removed. Therefore, when similar transformers are used, the voltages given by the delta and V connections are the same, and their outputs will be proportional to their line currents. Let I be the maximum current output per transformer. The current output per line of the Δ connection is $\sqrt{3}I$. The current output of the V connection is equal to the current output of one transformer or equal to I . Therefore, the output of the open delta will be $\frac{1}{\sqrt{3}}$ or 58 per cent. of the output of the delta. The

actual transformer capacity of the open delta is two-thirds of that of the delta, but all of this cannot be utilized on account of the power factors at which the transformers of the open delta operate

as compared with the power factor of the load. With a non-inductive balanced load, each transformer of the delta system carries one-third of the total load at unit power factor. Under the same conditions, each transformer of the open-delta system carries one-half of the load at a power factor of $\frac{\sqrt{3}}{2} = 0.866$. Multiplying 0.866 by $\frac{2}{3}$ gives 0.58, which is the capacity of the open delta as compared with the delta. The transformers of the open delta will not carry equal watt loads except when the power factor of the three-phase load is unity. The current loads will, however, be equal whenever the three-phase load is balanced.

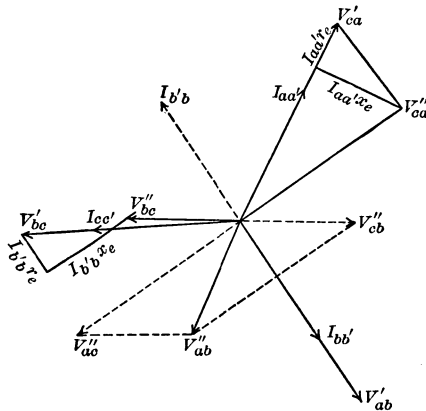

FIG. 132.

The output of a system made up of two groups of transformers in parallel, one group consisting of two transformers in open delta or V , while the other consists of three transformers in Δ , is only $33\frac{1}{3}$ per cent. greater than the output of the Δ -connected group alone and not 58 per cent. greater as might be expected (see page 286).

Fig. 132 is a vector diagram for two transformers connected in open delta or V . The lettering on this diagram corresponds to the lettering on the diagram of connections shown in Fig. 131. Equivalent resistances and equivalent reactances are used. Single and double primes indicate, respectively, primary and secondary values.

The transformers forming the open delta are *ca* and *bc*. Transformer *ca* carries the current $I_{aa'}$. Transformer *bc* carries the current $I_{bb'}$. The voltage across the open part of the delta, *i.e.*, across *ab*, will be equal to the vector sum of V_{ac} and V_{cb} . If θ is the angle of lag for the load, the current in the lines will lag behind the *Y* voltage of the system by an angle θ . To simplify the construction of the vector diagram, let θ be the angle of lag of the secondary current with respect to the primary voltage referred to the secondary, and assume the current load to be balanced with respect to the primary voltage.

The current $I_{aa'}$, Fig. 132, will lag behind V'_{ca} by an angle $\theta - 30$ degrees. On Fig. 132, θ is 30 degrees. Referring to Fig. 132, V'_{ca} , V'_{ab} and V'_{bc} are the three primary voltages referred to the secondary windings. V''_{ca} , V''_{ab} and V''_{bc} are the three corresponding secondary voltages. V''_{ab} is the voltage across the open side of the delta and is the vector sum of the voltages produced by the two transformers *ca* and *bc*.

$$V''_{ab} = V''_{ac} + V''_{cb}$$

It will be seen from Fig. 132 that the secondary voltages cannot be exactly balanced for a balanced load. The unbalancing on the diagram is very much greater than will be found in practice on account of the exaggerated impedance drops.

T Connection.—Two transformers with the same current ratings but with different voltage ratings are used. One transformer, which is called the “teaser,” is connected to the middle of the other as is indicated in Fig. 133. Both the primary and the secondary windings are connected in the same way. Fig. 133 will

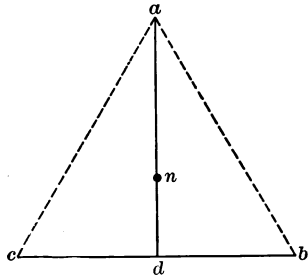

FIG. 133.

serve either for the diagram of connections or for the vector diagram of the voltages.

The teaser transformer is represented by *ad* on the diagram. The second transformer is indicated by the line *cb*. The three-phase voltages are impressed across the terminals, *a*, *b* and *c*. The secondaries being similarly connected will supply three-

phase power at a voltage which, except for the impedance drops, will be equal to the impressed voltage divided by the ratio of transformation.

If the impressed voltages are balanced, the primary voltages V_{ab} , V_{bc} and V_{ca} will be equal and each equal to $2V_{cd}$. The voltages V_{da} and V_{dc} and also V_{da} and V_{db} will be in quadrature.

$$V_{ca} = \sqrt{V_{da}^2 + V_{cd}^2}$$

The angle acd is 60 degrees; therefore,

$$\frac{V_{da}}{V_{ca}} = \sin 60 = \frac{\sqrt{3}}{2} = 0.866$$

The teaser transformer, therefore, should be wound for a voltage which is 86.6 per cent. of the voltage of the line or of the main transformer. Usually the teaser transformer is wound for the same voltage as the main transformer but is provided with a tap for 86.6 per cent. of full voltage.

A neutral point may be obtained from the T connection by bringing out a tap from the teaser transformer at a distance from a equal to two-thirds of the distance between a and d .

$$\frac{V_{na}}{V_{da}} = \frac{2}{3}$$

If n , Fig. 133, is the neutral point of the three-phase system,

$$\frac{V_{na}}{V_{ca}} = \frac{1}{\sqrt{3}}$$

$$V_{na} = \frac{1}{\sqrt{3}} V_{ca}$$

but

$$V_{da} = 0.866 V_{ca} = \frac{\sqrt{3}}{2} V_{ca}$$

therefore,

$$V_{na} = \frac{1}{\sqrt{3}} \frac{2}{\sqrt{3}} V_{da} = \frac{2}{3} V_{da}$$

The T system is unsymmetrical and, therefore, cannot give perfectly balanced secondary voltages under load conditions. It is, however, perfectly satisfactory and gives less unbalancing than the open delta.

Two exactly similar transformers can be used for the T connection with fair results, but this is not advisable except for temporary work or in an emergency. If the two transformers are similar, the one which is used for the teaser will have more turns than it should for the voltage impressed upon it and the impedance drop will be unnecessarily large.

Fig. 134 is a vector diagram for the T connection. The load is assumed to be balanced with respect to the primary voltage. The angle of lag, θ , is 30 degrees with respect to the primary voltage. All vectors are referred to the primary.

The voltage V'_{da} is in phase with the Y voltage of the system. The transformer da carries line current. Therefore, the power

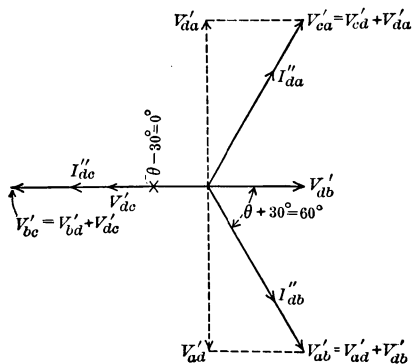

FIG. 134.

factor for the transformer da is the same as the power factor of the three-phase load.

The two halves of the secondary coil of the main transformer carry currents which are out of phase. Therefore, in order to find the voltage across the secondary, the transformer bc must be treated like a transformer with two secondary windings which are independently loaded. By inspection of Fig. 134, it will be seen that the T system is not symmetrical and cannot, therefore, give exactly balanced secondary voltages under load.

The capacity of the T system for three-phase transformation is somewhat less than the sum of the capacities of the two transformers used.

Take, for example, the case of a load at unit power factor and

assume that the teaser transformer, *i.e.*, transformer *da*, Fig. 133, is wound for the correct voltage. Let the line current and line voltage of the three-phase system be *I* and *V* respectively.

The transformer *da* has a voltage equal to $0.866V$ and works at the power factor of the load. Its output is therefore $0.866VI$. The two halves of the secondary of the other transformer carry the current *I* at a power factor equal to $\cos 30^\circ = 0.866$. Its output is, therefore,

$$VI \cos 30^\circ = 0.866VI$$

The total output of the system is

$$2(0.866VI)$$

The total rated capacity of the two transformers is

$$0.866VI + VI = 1.866VI$$

Comparing the actual output with the rated capacity gives

$$\frac{1.732VI}{1.866VI} = 0.928$$

as the fraction of the total transformer rating which is available for the three-phase output.

If the transformer *da* is wound for the same voltage as the transformer *bc* but has a voltage tap for 86.6 per cent. of full voltage, 86.6 per cent. of the rating of this transformer will be utilized. In this case the output of the *T* system will be 86.6 per cent. of the total transformer rating, or will be the same as the three-phase output of the same two transformers when connected in *V* or open delta.

Three- to Four-phase Transformation or Vice Versa.—Transformation from three- to four-phase or *vice versa* is easily accomplished by means of the Scott- or *T*-transformer connections. Referring to Fig. 133 it will be seen that the voltages across the primary terminals of each of the two transformers are in quadrature and are in the ratio of 1 to 0.866. The secondary voltages will also be in quadrature and in this same ratio.

A symmetrical four-phase system may be obtained on the secondary side by connecting the secondary windings together at

their middle points and adjusting the turns on the two secondary windings so that the voltages of both are equal. This can be accomplished by making the ratios of transformation of the two transformers ad and bc equal to $\frac{1}{0.866a}$ and $\frac{1}{a}$ respectively.

In order to have the two transformers interchangeable, both are usually provided with taps on their primary side for 0.866 per cent. of full voltage, but the tap on only one transformer is used.

The Scott connection for three- to four-phase transformation is shown in Fig. 135.

The point n of the common connection is the neutral point of the four-phase side. The secondaries may be considered to give either a four-phase or a two-phase system. The four-phase

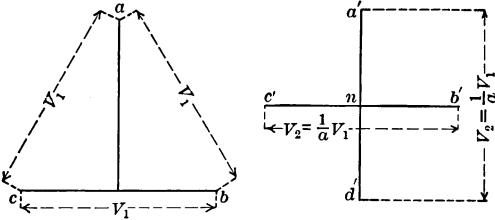

FIG. 135.

voltages are na' , nb' , nc' and nd' with n as a neutral point. The two-phase voltages are $a'd'$ and $b'c'$.

To transform from two-phase to three-phase, it is merely necessary to consider a' , b' , d' and c' , Fig. 135, as the primary terminals and a , b and c as the secondary terminals.

If the Scott connection is used to transform from two-phase to three-phase, one of the three-phase voltages, *i.e.*, V_{cb} is derived directly from one transformer. The other two three-phase voltages are equal to the vector sum of two quadrature voltages one of which is derived from each of the two transformers. Therefore, neglecting the insignificant effect of the impedance drops in the transformers, the wave form of the voltage V_{bc} will be the same as the wave form of the voltage impressed on the two-phase side. The other two three-phase voltages, however, will not be of the same wave form as the two-phase voltage

or of like form except when the two-phase voltage is sinusoidal, since the harmonics in the resultant of the two voltages which are out of phase are different in phase from the harmonics in the components.

If power is put in on the three-phase side, one of the two-phase voltages, *i.e.*, *c'b'*, will be of the same wave form as the three-phase voltages. The other, however, except when the impressed voltage is sinusoidal, will be either more or less peaked than the impressed voltage. Whether it is more or less peaked will depend upon the harmonics present and their phase relations.

Let the voltage drops across the two-phase side of the Scott-connected transformers, Fig. 135, be

$$\begin{aligned}
 e_{v'c'} &= E_1 \sin(\omega t + \alpha_1) + E_3 \sin(3\omega t + \alpha_3) \\
 &\quad + E_5 \sin(5\omega t + \alpha_5) + E_7 \sin(7\omega t + \alpha_7) \\
 e_{d'a'} &= E_1 \sin(\omega t + \alpha_1 - 90^\circ) + E_3 \sin(3\omega t + \alpha_3 + 90^\circ) \\
 &\quad + E_5 \sin(5\omega t + \alpha_5 - 90^\circ) + E_7 \sin(7\omega t + \alpha_7 + 90^\circ)
 \end{aligned}$$

These two voltages are alike in wave form but differ by 90 degrees in phase.

Assume a ratio of transformation of unity between the three-phase and four-phase voltages. The voltage drops across the three-phase side of the transformers will then be

$$\begin{aligned}
 e_{ab} &= 0.866e_{a'd'} + 0.5 e_{c'v'} \\
 e_{ca} &= 0.866e_{d'a'} + 0.5 e_{c'v'}
 \end{aligned}$$

Referred to *bc* as an axis, the three-phase voltages are:

$$\begin{aligned}
 e_{bc} &= E_1 \sin(\omega t + \alpha_1) + E_3 \sin(3\omega t + \alpha_3) \\
 &\quad + E_5 \sin(5\omega t + \alpha_5) + E_7 \sin(7\omega t + \alpha_7) \quad (83)
 \end{aligned}$$

$$\begin{aligned}
 e_{ca} &= E_1 \sin(\omega t + \alpha_1 - 120^\circ) + E_3 \sin(3\omega t + \alpha_3 - 240^\circ) \\
 &\quad + E_5 \sin(5\omega t + \alpha_5 - 120^\circ) + E_7 \sin(7\omega t + \alpha_7 - 240^\circ) \quad (84)
 \end{aligned}$$

$$\begin{aligned}
 e_{ab} &= E_1 \sin(\omega t + \alpha_1 - 240^\circ) + E_3 \sin(3\omega t + \alpha_3 - 120^\circ) \\
 &\quad + E_5 \sin(5\omega t + \alpha_5 - 240^\circ) + E_7 \sin(7\omega t + \alpha_7 - 120^\circ) \quad (85)
 \end{aligned}$$

It will be seen from equations (83), (84) and (85) that the wave forms of the voltages V_{ab} and V_{ca} are different from the wave form of the voltage V_{bc} . All three of the three-phase voltages contain third harmonics which differ by 120 degrees in phase. Except when three-phase voltages are obtained from Scott-

connected transformers or some other unsymmetrical system, they cannot contain third harmonics (see page 47).

The wave forms of the three-phase voltages are plotted in Fig. 136 for the case where the two-phase voltages contain 30 per cent. third harmonics. The angles α_1 and α_3 are assumed

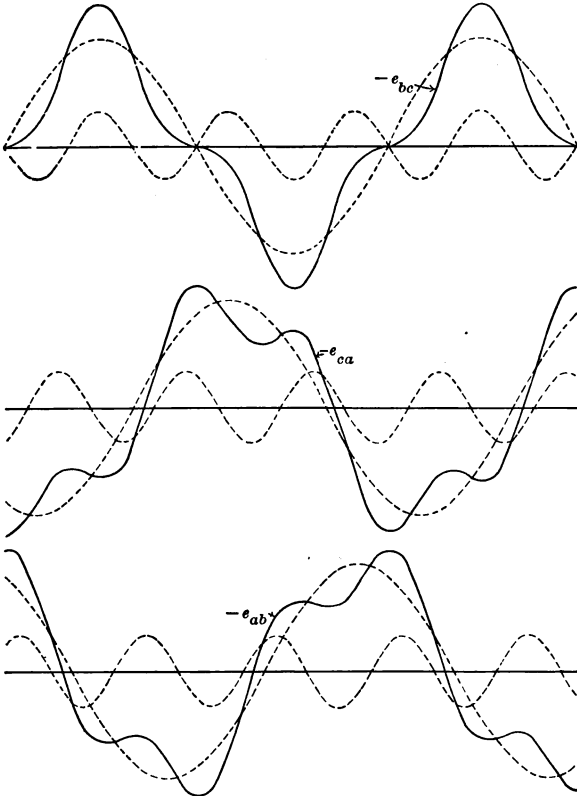

FIG. 136.

to be 0° and 180° respectively. The fundamentals and the third harmonics of each wave are shown dotted.

Three- to Six-phase Transformation.—*Double Δ and Double Y.*—A six-phase system may be derived from any three-phase system by the use of three single-phase transformers which are each provided with two independent secondary windings. The

primaries should be connected for three-phase in either Y or Δ . The two sets of secondaries are connected to form two independent three-phase systems with the connections of one set of secondaries reversed with respect to the connections of the other.

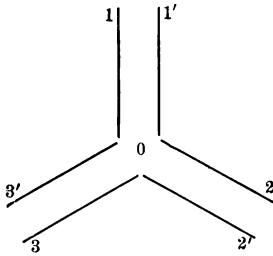

FIG. 137.

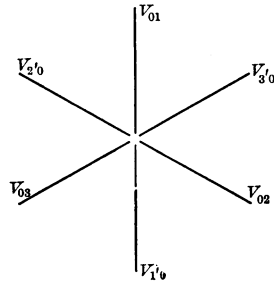

FIG. 138.

The phase relations of the six secondary voltages are shown by Fig. 137. Reversing one group of secondaries gives the phase relations shown by Fig. 138.

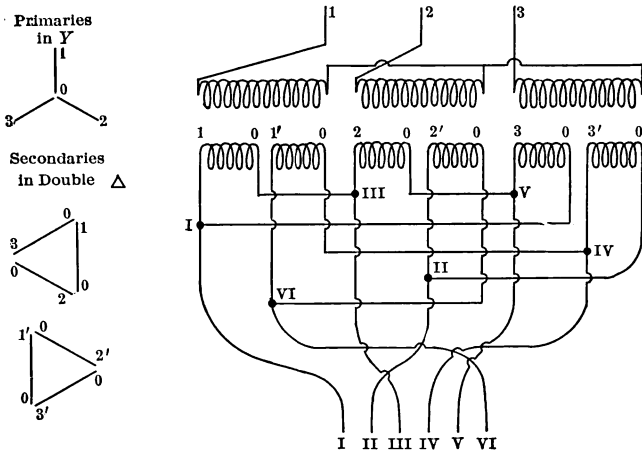

FIG. 139.

The two groups of secondaries may be connected in Δ or in Y giving what is known as the double- Δ or the double- Y connection respectively. In case of either the double- Y or the double- Δ

connection, one-half of the power delivered by the transformers will be supplied by each group of secondaries at the three-phase voltage. The connections with the secondaries in double Δ and with the primaries in Y are shown in Fig. 139. The connections are shown diagrammatically at the left of the figure. The actual connections are shown at the right. Fig. 140 shows the diagrammatic and the actual connections for the double Y .

The two deltas forming the double Δ have no electrical connection and therefore cannot be considered to form a true six-phase system. When, however, they are connected to the armature of a motor or a synchronous converter, the electrical

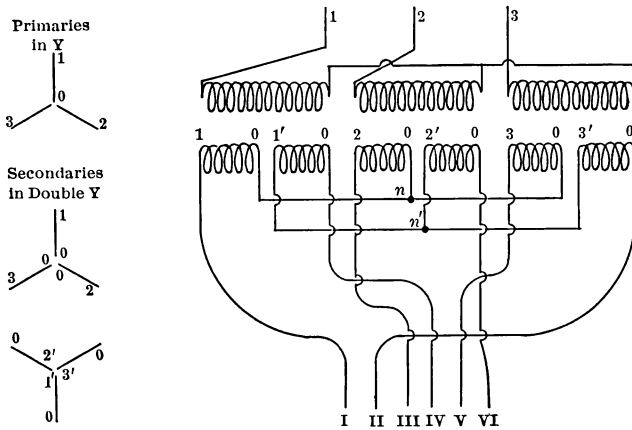

FIG. 140.

connection between the two deltas is established and the effect is the same as if six-phase power was being fed to the machine. The two Y 's forming the double Y may be interconnected at their neutral points, n and n' , and form, under this condition, a true star six-phase system.

Diametrical Connection.—Three single-phase transformers with single secondaries may be used to supply six-phase power to a rotary converter or motor by making use of what is known as the diametrical connection for the secondaries. The diametrical connection is probably more used than either the double Δ or the double Y . The double Y is always used when a neutral point is desired for grounding or for the neutral wire of a three-

wire direct-current system which receives power from a six-phase rotary converter.

The diagram of connections for the diametrical connection of transformers to feed six-phase power is shown in Fig. 141. The hexagon at the bottom represents the armature which is to receive six-phase power.

If taps are brought out from the middle points of each of the three secondaries and these taps are interconnected, the diametrical connection becomes the double Y.

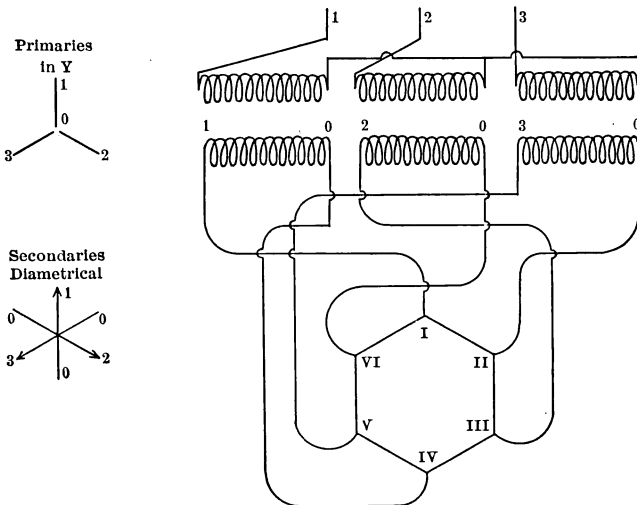

FIG. 141.

Two- or Four-phase to Six-phase Transformation.—Two- or four-phase to six-phase transformation may be accomplished by use of double-*T* connection on the secondary side of Scott transformers. The connections for this are shown in Fig. 142.

The ratio between the primary and secondary voltages should be the same as for the Scott transformers. If the primaries are also connected in *T*, the Scott transformers may be used to transform from three- to six-phase.

The chief use of three- to six-phase transformation is in connection with rotary converters which are more efficient and give a greater output for the same copper loss when connected for

six-phase than when connected for three-phase. All rotary converters of more than a few hundred kilowatts capacity are tapped for six-phase and are operated through transformers from three-phase mains.

A rotary converter connected for twelve phases will give a larger output than when connected for three phases, and in addition it possesses certain other marked advantages, the principal among which is the much more uniform distribution of armature copper loss. Twelve-phase converters are not at present built, but it is quite possible that with the growing demand for larger units they may come into use. For this reason the transformer connections for changing from three- to twelve-phase will be given. One of these, namely, the double-chord connection, is very simple.

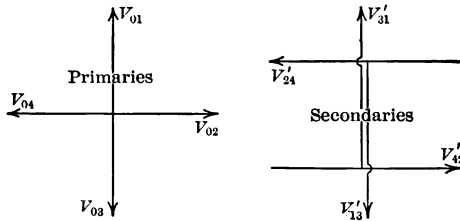

FIG. 142.

Three- to Twelve-phase Transformation.—There are 30 degrees difference in phase between corresponding *Y* and Δ voltages of a three-phase system. Therefore, two groups of transformers connected for three- to six-phase transformation will have their corresponding six-phase voltages 30 degrees apart, provided the primaries of one group are connected in Δ and the primaries of the other are connected in *Y*. If the ratios of transformation of the Δ - and *Y*-connected groups of transformers are in the ratio of

a to $\frac{a}{\sqrt{3}}$, the six-phase voltages of both groups will be equal in magnitude and they may be interconnected to give either a star or a mesh twelve-phase system. The diagram of connections and the phase relations of the primary voltages are shown in Fig. 143.

Fig. 144 gives the secondary connections and vectors of the twelve-phase star connection. To simplify the reference to

Fig. 143, the secondary voltages are assumed to be in phase with the primary voltages instead of in opposition to them.

The connections shown in Fig. 144 require six single-phase

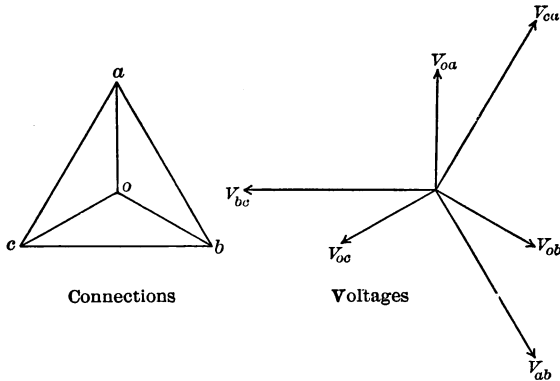

FIG. 143.

transformers or two three-phase transformers with two different ratios of transformation. The complication of such connections would as a rule offset any gain that might be derived from their use.

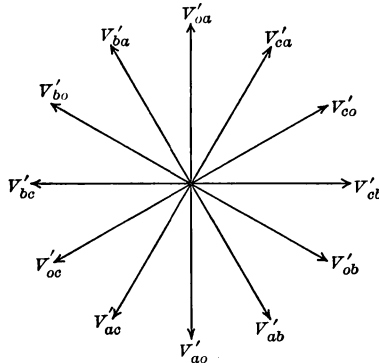

FIG. 144.

The equivalent of twelve phases may be obtained for any mesh-connected twelve-phase system by the use of a very simple double-chord connection which requires only three single-

phase transformers or one three-phase transformer. Each transformer, or phase in the case of the three-phase transformer, must have two similar secondary windings. All secondaries will be wound for the same voltage and the same current. The chord connection can be used to supply twelve-phase power from a three-phase system.

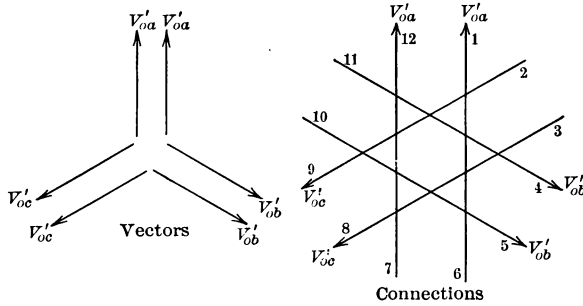

FIG. 145.

Fig. 145 shows the vector diagram of the voltages and the connections of the twelve-phase double-chord connection.

The chord voltages are approximately 96.5 per cent. of the diametrical voltage.

CHAPTER XXI

THREE-PHASE TRANSFORMERS; THIRD HARMONICS IN THE EXCITING CURRENTS AND IN THE INDUCED VOLTAGES OF Y- AND Δ -CONNECTED TRANSFORMERS; ADVANTAGES AND DISADVANTAGES OF THREE-PHASE TRANSFORMERS; PARALLEL OPERATION OF THREE-PHASE TRANSFORMERS OR THREE-PHASE GROUPS OF SINGLE-PHASE TRANSFORMERS; V- AND Δ -CONNECTED TRANSFORMERS IN PARALLEL

Three-phase Transformers.—A considerable saving in material and therefore in the cost of transformers required for three-phase circuits may be effected by combining their magnetic circuits.

Core Type.—For example, consider the case of three similar single-phase core-type transformers which are to be used on a

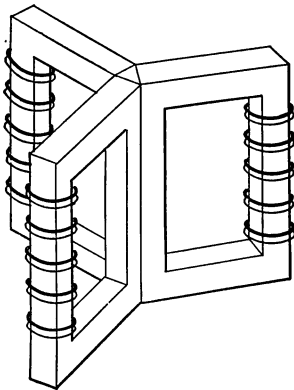

FIG. 146.

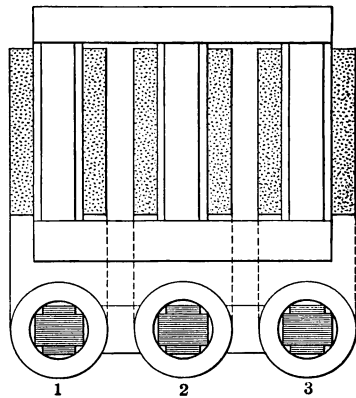

FIG. 147.

three-phase circuit. If both windings on each transformer are placed on one side of the core and the opposite sides of the iron cores are butted together as shown in Fig. 146, the component fluxes in the three sides which are placed together will be 120 degrees apart in time phase and their resultant will be zero. The

common portion of the iron core may, therefore, be removed without affecting the operation of the transformers.

The core type of three-phase transformer as actually built has the three parts of the core which carry the windings in one plane as shown in Fig. 147. This arrangement is derived from that shown in Fig. 146 by removing the parts of the cores which butt together and then contracting the horizontal portions of the

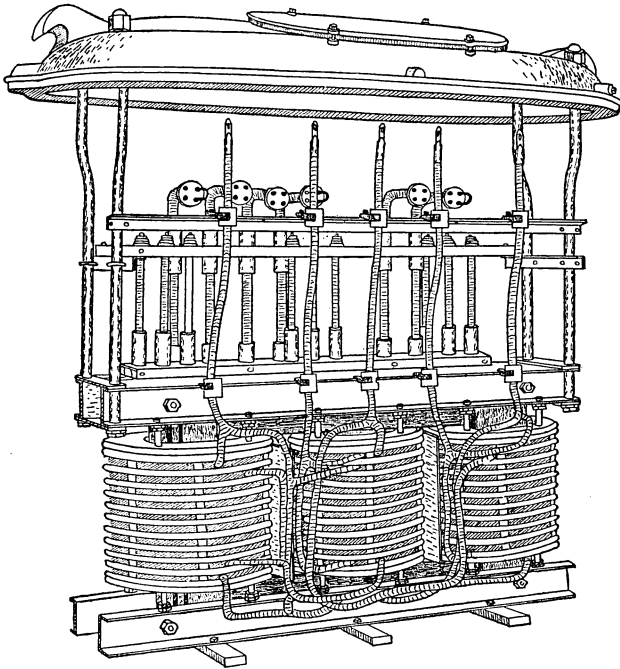

FIG. 148.

core of one phase and bending the corresponding parts of the cores of the other two phases until the three windings lie in the same plane.

Any one leg of the iron core will carry a flux which is the resultant of the fluxes in the other two; consequently, the reluctances of the magnetic circuits for the fluxes of phases 1 and 3, Fig. 147, will be slightly greater than the reluctance of the magnetic circuit for the flux of phase 2. The only effect of this

will be a slight unbalancing of the magnetizing currents. This will have little influence upon the operation of the transformer.

The yokes between the portions of the iron core which are surrounded by the windings form a Y coupling for the three magnetic circuits of the three-phase transformer shown in Fig. 147. They, therefore, carry the same flux, neglecting the leakage fluxes, and should have the same cross-section as the portions of the iron core surrounded by the windings. The yokes may be arranged in Δ , but this arrangement is more expensive to construct and requires more space and possesses no particular advantage, and is not used. A three-phase core-type transformer is shown in Fig. 148.

Shell Type.—When the three-phase transformer is of the shell type, the windings are embedded in the iron core instead of

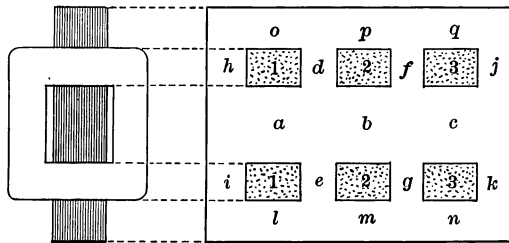

FIG. 149.

surrounding the iron core as in the core type. The usual arrangement of a shell-type, three-phase transformer is shown in Fig. 149, which gives two sectional views. The three groups of coils are 1-1, 2-2 and 3-3.

The resultant magnetomotive force producing flux along the whole length of the core, *i.e.*, along the line a, b, c , is the vector sum of the three magnetomotive forces due to the three groups of windings. If the three groups of coils are connected in the same relative direction, the magnetomotive forces produced by them will be 120 degrees apart and their vector sum taken along abc will be zero. The flux passing between the two pairs of adjacent windings 1 and 2 and 2 and 3 in the spaces d and e and f and g , respectively, will be equal to one-half of the vector difference of two fluxes which are equal but 120 degrees apart.

The fluxes in the spaces d and e and f and g , therefore, are equal to $\frac{1}{2}\sqrt{3} = 0.866$ of the flux linking a single phase.

The magnetomotive forces acting to produce fluxes between any pair of coils are in parallel instead of in series as in the case of the core type of transformer. The magnetic circuits of the three phases of a shell-type transformer are, therefore, much more independent of one another than the magnetic circuits of a transformer of the core type. If the flux is prevented, in any way, from passing through the windings of any one phase of a shell type of transformer, there will still be magnetic circuits for the fluxes of the other two phases and they may be operated in open delta. Two windings of a core-type transformer cannot be operated in open delta if the flux is prevented from passing through the core of the third phase, since in this case both of the active windings would have to carry the same flux instead of fluxes 120 degrees apart, as they should. The action of a shell-type transformer under the preceding conditions is of some importance since it permits such a transformer to be operated temporarily with one winding out. If one winding of a shell type becomes injured in any way, the remaining two windings may be operated in open delta giving 58 per cent. of the normal capacity of the transformer, provided the injured winding is disconnected and either its primary or its secondary winding, or preferably both, are short-circuited. If the injured phase is short-circuited, any current which flows in it will have no circuit upon which to react and will, therefore, be all magnetizing current. As a result of this, any flux which tends to pass through the injured phase will be forced back and only a very small current will flow in the short-circuited phase. The voltage induced in this phase will merely be equal to the impedance drop due to this small current. If one phase of a core-type transformer is short-circuited, the remaining two cannot be operated in open delta since their magnetic circuits would be in series.

Some iron may be saved in the construction of a shell-type transformer by reversing the connections of the middle phase, that is, by reversing the connections of the windings of phase 2, Fig. 149. If the connections of the middle coil are reversed, the fluxes carried by the portion of the core between the coils, *i.e.*, by the portions d , e , f and g , will as before be equal to one-half

of the vector difference of the fluxes linking two adjacent windings, but in this case the fluxes threading two adjacent windings are 60 degrees apart instead of 120 degrees. Their vector difference will, therefore, be numerically equal to either flux, and the parts *d*, *e*, *f* and *g* of the core will carry fluxes which are equal to one-half of the flux through any one coil instead of 0.866 of this flux, as was the case when the windings of all phases were connected similarly. When the middle phase is reversed the cross-section of the magnetic circuit throughout the transformer should be the same. It should be remembered that

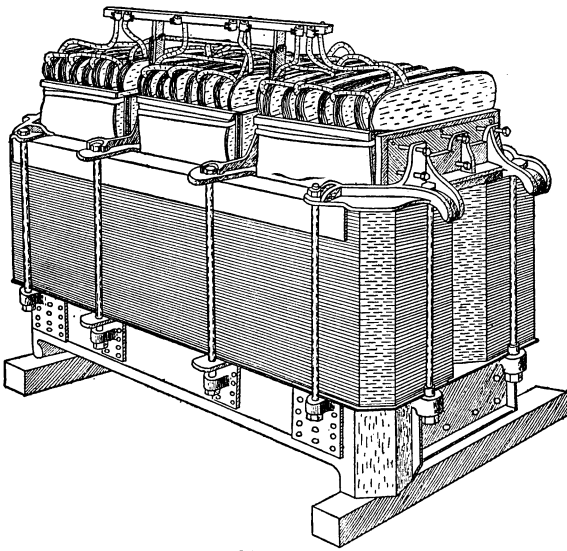

FIG. 150.

certain portions of the magnetic circuit consist of two parallel paths. With the middle coil reversed the cross-sections of *a*, *b*, *c*, *h* + *i*, *d* + *e*, *f* + *g*, *j* + *k*, *o* + *l*, *p* + *m*, and *q* + *n* should be equal. If the phases are all connected similarly, the cross-sections of *d* + *e* and *f* + *g* must be $\sqrt{3} = 1.73$ times the cross-section of the other parts of the magnetic circuit.

The actual appearance of a three-phase shell-type transformer is shown in Fig. 150.

Third Harmonics in the Exciting Currents and in the Induced Voltages of *Y*- and Δ -connected Transformers.—Due to the

variation in the permeability of the core of a transformer with varying flux density as well as to hysteresis, the wave form of the magnetizing current of a transformer will be different from the wave form of the impressed voltage. If the impressed voltage is sinusoidal, the magnetizing current will not be sinusoidal but will contain harmonics, the most prominent among which is the third.

Consider first three single-phase transformers connected for three-phase. If sinusoidal electromotive forces are impressed on three single-phase transformers which have their primary windings connected in Y with a neutral, there will be a third harmonic in the magnetizing current of each phase. These harmonic component currents will flow over the three lines and return on the neutral, where they will all be in conjunction and will add directly giving a third-harmonic current in the neutral equal to three times the third-harmonic current in each line. Under this condition the voltage induced in each transformer will be of the same wave form as the impressed voltage, except as its shape may be very slightly modified by the impedance drop in the primary winding. If the neutral connection is broken, there can be no third harmonic in the magnetizing current and the flux in each transformer will then be so modified that a third-harmonic voltage will be induced in each winding. This harmonic voltage cannot appear between any pair of lines, since the third harmonics in the two phases between any pair of lines will be in opposition and will, therefore, neutralize. There will be third-harmonic voltages induced in the secondary windings. If these are connected in Y this harmonic voltage will appear between the lines and neutral, but it cannot appear between any pair of lines.

If the secondaries are in Δ , the third-harmonic voltages induced in them will be in conjunction in the closed Δ and will cause a third-harmonic current to circulate in the delta. This current has no electric circuit upon which it can react. It will, therefore, act as a third-harmonic magnetizing current for the core and will suppress the third harmonic in the induced voltage.

The third-harmonic current in the closed Δ will not be large compared with the rated current of the transformers, since it can be no larger than the third-harmonic components which

would exist in the exciting currents of the transformers if they were excited, on the side in which it occurs, from a single-phase line. It may, however, in extreme cases be equal to 30 or even 50 per cent. of the fundamental of the normal exciting currents. Its magnitude will depend very largely upon the magnetic density at which the cores of the transformers are operated. It will increase rapidly with the magnetic density.

If the Δ in which this third-harmonic current flows is opened, a large third-harmonic voltage will appear across the gap. Since, with respect to one another, the third harmonics in the three transformers are $3 \times 120 = 360$ degrees apart in phase, this voltage will be equal to three times the third-harmonic voltage the third-harmonic current in the closed Δ produces in each transformer. The third-harmonic voltage in each transformer may be as great as 40 or even 50 per cent. of the rated voltages of the transformers if the cores are operated at high magnetic density, and will usually be as much as 25 per cent. If the transformers have both primaries and secondaries Y -connected, the third-harmonic voltage will not appear between the mains, but will appear between the mains and neutral. If it were 50 per cent. of the fundamental, the root-mean-square value of the resultant voltage to neutral would be $\sqrt{(50)^2 + (100)^2} = 112$ per cent. of the rated voltage.¹ The increase in the maximum voltage of the wave would be much more than 12 per cent. The effect of this increase in voltage is not only to give an abnormal ratio of transformation, but also to increase the insulation strain in the transformers. An increase of 10 or 12 per cent. in voltage, with a much greater corresponding increase in the maximum voltage, is of importance in very high-voltage transformers where the factor of safety of the insulation may not be much over 2.

If the primaries are in Δ , each phase may be considered to receive power independently of the others and the required third harmonic in the magnetizing currents may be considered to come in over the lines. A little thought, however, will show that the third-harmonic component currents which come in over any one line for the two phases connected to that line will neutralize. The result is, there will be merely a third-harmonic current circulating in the closed Δ formed by the primary windings.

¹Suppressing the third harmonic in the magnetizing current flattens the flux wave and therefore peaks the voltage wave.

The effect of this current will be the same as the effect of the third-harmonic current which existed in the secondary windings when they were in Δ with the primaries in Y without neutral connection.

What has been said about third harmonics in single-phase transformers connected for three-phase transformation applies equally well to three-phase shell-type transformers, but does not apply to the three-phase core type. The portions of the core about which the windings of a three-phase core-type transformer are placed are joined in Y without a common return corresponding to the neutral wire of a Y -connected electric circuit. This should be made clear by referring to Fig. 146, page 272, remembering, however, that the central portion of the core shown in this figure, *i.e.*, the portion made by the three sides which are butted together, is left out in a three-phase transformer. A little thought will show that the two third-harmonic fluxes in any magnetic circuit which includes two of the upright portions of the core are in time-phase opposition and cancel. There can be, therefore, no third harmonic in the mutual flux of a three-phase core-type transformer with balanced impressed voltages, but there may be a third-harmonic leakage flux between any two upright legs of the core. This leakage flux will be small compared with the mutual flux on account of the high reluctance of its path. There can be no third-harmonic voltages in the windings of a core-type three-phase transformer with symmetrical magnetic circuits under the condition of balanced impressed voltages except those due to the third-harmonic leakage fluxes. These latter should be very small. Neither can there be any third-harmonic components in the magnetizing currents in any of the windings no matter how connected.

In what follows balanced impressed voltages will be assumed and the effect of the leakage fluxes will be neglected. Sinusoidal impressed voltage will also be assumed. Assume the primaries are connected in Y with neutral. Let the secondaries be open. Under this condition the primary windings receive power independently of one another. The neutral may be considered to carry the combined third-harmonic currents for the three phases provided such currents exist.

Refer to Fig. 146. Consider the common central leg of the

core removed. There will then be no common return path for the third-harmonic flux. Let the instantaneous values of the magnetomotive forces of the three phases at any instant due to the magnetizing currents be \mathcal{F}_1 , \mathcal{F}_2 and \mathcal{F}_3 and let \mathcal{R}_1 , \mathcal{R}_2 and \mathcal{R}_3 be the corresponding instantaneous values of the reluctances of the three magnetic circuits up to their common junctions. Let φ_1 , φ_2 and φ_3 be the instantaneous values of the fluxes.

Then

$$\begin{aligned}\mathcal{F}_1 - \mathcal{R}_1\varphi_1 - \mathcal{F}_2 + \mathcal{R}_2\varphi_2 &= 0 \\ \mathcal{F}_1 - \mathcal{R}_1\varphi_1 - \mathcal{F}_3 + \mathcal{R}_3\varphi_3 &= 0 \\ \varphi_1 + \varphi_2 + \varphi_3 &= 0\end{aligned}$$

Solving for φ_1 gives

$$\varphi_1 = \frac{(\mathcal{F}_1 - \mathcal{F}_2)\mathcal{R}_3 + (\mathcal{F}_1 - \mathcal{F}_3)\mathcal{R}_2}{\mathcal{R}_1\mathcal{R}_2 + \mathcal{R}_2\mathcal{R}_3 + \mathcal{R}_3\mathcal{R}_1}$$

The expression for the flux φ_1 is perfectly general. Similar expressions hold for φ_2 and φ_3 .

If the primaries are in Y with neutral, the third-harmonic components in the magnetizing currents which would ordinarily be necessary to produce a sinusoidal flux can come in over the neutral. As a matter of fact, no such third-harmonic components are necessary for a core-type transformer and will not exist.

Assume φ_1 is sinusoidal and that \mathcal{F}_1 , \mathcal{F}_2 and \mathcal{F}_3 contain the necessary third harmonics. These third harmonics are all in phase. They are equal since the reluctances of the three magnetic circuits are equal. They will, therefore, affect all three magnetomotive forces alike and as the magnetomotive forces enter in the expression for the flux as the difference of pairs, the third harmonics may be suppressed without altering the flux (Equation for φ_1). The third harmonics are, therefore, not required in the magnetomotive forces of a core-type transformer to produce a sinusoidal flux variation in each phase. No third harmonic components will exist in the magnetizing currents or in the primary neutral. Opening the neutral will, therefore, not alter the fluxes or induced voltages in the transformer. If the secondaries are in Δ with the primaries in Y without neutral, no third-harmonic magnetizing current will exist in them as existed in the secondaries of a three-phase shell-type transformer or in

the secondaries of three single-phase transformers under similar conditions.

The transformer shown in Fig. 146 has a core which is symmetrical with respect to the three phases. The core of the ordinary three-phase core-type transformer is like that shown in Fig. 147 and is unsymmetrical. The reluctances for the three phases are not equal. As a result the magnetizing currents will be somewhat unbalanced and there will be current of fundamental frequency in the neutral if the primaries are *Y*-connected with neutral. If there is no neutral connection, the *Y* voltages will be slightly unbalanced. There may also be small third-harmonic magnetizing currents with the neutral closed. When the neutral is opened there will be corresponding harmonics in the induced voltages.

If the generator supplying the transformer has a third harmonic in its phase voltage and the primaries of the transformers are in *Y* with their neutral connected to the neutral of the generator, there may be pronounced third-harmonic currents in the transformers, the lines and the neutral connection. Since the third-harmonic magnetomotive forces for the three phases are in phase they cannot produce any mutual flux. The conditions so far as the third harmonics are concerned are the same as those existing in a single-phase core-type transformer with two equal sections of the primary winding bucking and on opposite sides of the core. The third harmonic voltages impressed on each phase will be short-circuited through the resistance and third-harmonic leakage reactance of each phase. The third-harmonic leakage flux which causes the third-harmonic leakage reactance is not like the ordinary leakage flux for the fundamental which passes between the primary and secondary windings, but is a leakage flux which links both primary and secondary windings and passes between the upright legs of the core. It is a leakage flux for the core but not for the windings. The leakage reactance caused by this third-harmonic leakage flux is much higher than the ordinary leakage reactance for the fundamental chiefly on account of the higher frequency of the third harmonic and on account of the much larger cross-section of the air path for the third-harmonic leakage flux. The third-harmonic leakage flux links both primary and secondary windings and induces third-harmonic voltages in each.

Advantages and Disadvantages of Three-phase Transformers.

—*Advantages.*—Three-phase transformers require less material for a given output than the three single-phase transformers they replace. They therefore are lighter, cost less, require less floor space and have a higher efficiency than three single transformers of equivalent capacity.

The windings of a three-phase transformer may be connected for Y or Δ inside of the containing tank, thus reducing the number of high-tension leads which have to be brought out through the tank. Only three high-potential leads need to be brought out, while in the case of three single-phase transformers six must be brought out for Δ connection and six for Y , except in the case of very high-potential transformers when one terminal of their high-potential windings is usually grounded onto the tank. As very high-potential transformers are always connected in Y on their high-potential sides, and the neutral point grounded, there is no object in insulating more than one end of the high-potential winding from the tank.

—*Disadvantages.*—The three principal disadvantages of three-phase transformers or, in general, of polyphase transformers are the greater cost of spare units, the greater cost of repairs, and the greater derangement of service in case of breakdown.

In small distributing systems having few transformers of any one size, the relative cost of spares with single- and three-phase transformers is the relative cost of one single-phase transformer as compared with one three-phase transformer. When, however, a distributing system is large and requires many transformers, the number of spares required compared with the total number of transformers in service is much smaller than in the case of a small system, and the increase in the cost of the spares is small compared with the saving in the cost of the transformers required for the whole system. In such a case, the total cost of three-phase transformers with the necessary spares will be usually less than the cost of an equivalent capacity in single-phase transformers also including spares. The gain in efficiency and the decreased cost of transportation due to the decrease in total weight for a given capacity, and also the decrease in the cost of installation on account of the simplification of the wiring, are important items favoring three-phase transformers.

The greater damage in the case of a bad short-circuit on one phase is not a very important item except when transformers are used in exposed places where they are liable to be subjected to severe strains from lightning or from other causes.

Parallel Operation of Three-phase Transformers or Three-phase Groups of Single-phase Transformers.—The conditions which must be fulfilled for the parallel operation of single-phase transformers must also be fulfilled for the parallel operation of

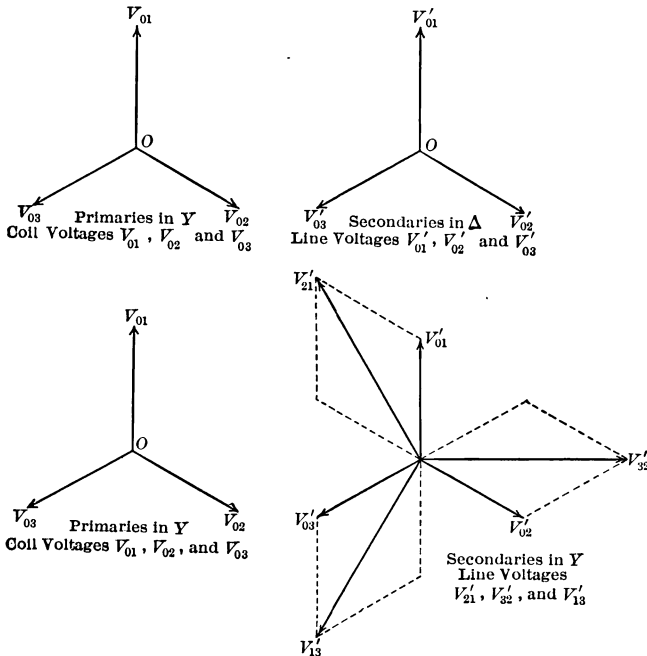

FIG. 151.

transformers on polyphase circuits. These conditions are: ratios of transformation and voltages which make the voltages between the three-phase lines equal, equivalent impedances which, when referred to the same voltage, are inversely proportional to the rating of the transformers, and equal ratios of equivalent resistance to equivalent reactance.

Three-phase transformers or groups of three-phase transformers, which are fed from a common source, cannot be paral-

leled indiscriminately, even when the conditions as stated are fulfilled, since there is a phase difference between the corresponding secondary voltages given by certain of the connections. For example, if the primaries of two groups of transformers are connected in Δ and the secondaries of one group are in Y and of the other in Δ , there will be a phase difference of 30 degrees between corresponding secondary voltages. This is shown in Fig. 151 which gives vector diagrams of the voltages obtained. The secondary line voltages given by the two connections may be made equal by using proper ratios of transformation, but they cannot be brought into phase. The smallest difference in phase between the secondary line voltages given by the two connections is 30 degrees. A Y - Δ system cannot be paralleled with a Y - Y , Δ - Δ , or a T - T system, but a Δ - Δ system may be paralleled

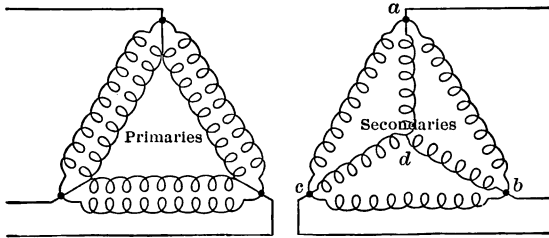

FIG. 152.

with a Δ - Δ , Y - Y or a T - T . The secondary voltages of a Y - Δ and a Δ - Y system will be either in phase or 60 degrees out of phase depending upon the way the connections are made. Two such systems may, therefore, be paralleled.

Any group of three-phase transformers which are fed from independent sources may be paralleled on their secondary sides provided the magnitudes of the voltages are the same. In this case the relative phase relation of the sources is free to accommodate itself to the conditions imposed by the transformer connections.

In order to show the magnitude of the short-circuit current produced if two groups of three-phase transformers supplied from the same source should be put in parallel when their connections are such that they cannot properly be paralleled, consider a particular case. Let the primaries of both groups of transformers be connected in Δ . Let the secondaries of one be in Δ

and the other in Y . Assume that the transformers in the two groups are wound for the same primary voltage and are identical except in their ratios of transformation which are in the ratio of $1:\sqrt{3}$. Let the impedance voltage of the transformers be 5 per cent. of their rated voltage at full-load current. The connections are shown diagrammatically in Fig. 152.

Let the ratio of transformation of the Δ -connected group be unity. The ratio of transformation of the Y -connected group will then be $\sqrt{3}$. If z is the impedance of the primaries, the equivalent impedances, referred to the secondaries, of the Δ - and of the Y -connected groups are, respectively, $2z$ and $\frac{1}{3}z + \frac{1}{3}z = \frac{2}{3}z$.

According to Kirchoff's laws

$$\begin{aligned} \bar{E}_{bd} + \bar{E}_{da} + \bar{E}_{ab} &= \bar{I}_{bd} \frac{2}{3}z + \bar{I}_{da} \frac{2}{3}z + \bar{I}_{ab} 2z \quad (86) \\ \bar{I}_{da} &= \bar{I}_{ab} + \bar{I}_{ac} \\ \bar{I}_{bd} &= \bar{I}_{ab} + \bar{I}_{cb} \end{aligned}$$

Since the system is symmetrical the currents in the two groups of transformers will be balanced, *i.e.*, the phase currents in each group will be equal in magnitude and will differ by 120 degrees in phase. There will be the usual phase displacement between the Δ and Y currents. Therefore

$$\begin{aligned} \bar{I}_{da} &= \sqrt{3} \bar{I}_{ab} (\cos 30^\circ - j \sin 30^\circ) \\ &= \sqrt{3} \bar{I}_{ab} (0.866 - j 0.500) \\ \bar{I}_{bd} &= \sqrt{3} \bar{I}_{ab} (\cos 30^\circ + j \sin 30^\circ) \\ &= \sqrt{3} \bar{I}_{ab} (0.866 + j 0.500) \end{aligned}$$

Substituting these values of \bar{I}_{da} and \bar{I}_{bd} in equation (86) gives

$$\begin{aligned} (\bar{E}_{bd} + \bar{E}_{da}) + \bar{E}_{ab} &= z \bar{I}_{ab} \left\{ \frac{2}{3} \sqrt{3} (0.866 + j 0.500) \right. \\ &\quad \left. + \frac{2}{3} \sqrt{3} (0.866 - j 0.500) + 2 \right\} \\ &= 4\bar{I}_{ab} z \end{aligned}$$

The voltage $(\bar{E}_{bd} + \bar{E}_{da})$ is equal to the voltage $-E_{ab}$ in magnitude but will differ from it by 30, 90 or 150 degrees in phase according to the way the Δ - and Y -connected groups of secondaries are connected together.

Consider the connection which gives the least phase displacement and therefore the least short-circuit current. For this

displacement, *i.e.*, for a displacement of 30 degrees, the voltage $\{(\bar{E}_{bd} + \bar{E}_{da}) + \bar{E}_{ab}\}$ will be equal to

$$2 \cos \left(\frac{180^\circ - 30^\circ}{2} \right) E_{ab} = 0.518 E_{ab}$$

For this condition

$$0.518 E_{ab} = 4 \bar{I}_{ab} z$$

$$I_{ab} = I_{\Delta s.c.} = E_{ab} \frac{0.518}{4z} \quad (87)$$

where $I_{\Delta s.c.}$ is the short-circuit current in the Δ -connected group.

Since a 5 per cent. impedance drop at full-load current was assumed the full-load current, $I_{\Delta f.l.}$, in each of the Δ -connected transformers may be found from

$$I_{\Delta f.l.} (2z) = 0.05 E_{ab}$$

$$I_{\Delta f.l.} = \frac{0.05}{2z} E_{ab} \quad (87a)$$

Substituting the value of E_{ab} from equation (87a) in equation (87) gives

$$I_{\Delta s.c.} = 5.18 I_{\Delta f.l.}$$

or 5.18 times the rated full-load current. The current in each winding of each transformer will be 5.18 times its rated full-load value.

If a Δ - Y group had been paralleled with a Y - Δ group, the short circuit current would have been either about twice as great as in the case assumed or zero according to the way the connections between the two groups of transformers were made.

V- and Δ - connected Transformers in Parallel.—If two equal transformers connected in V are operated in parallel with three

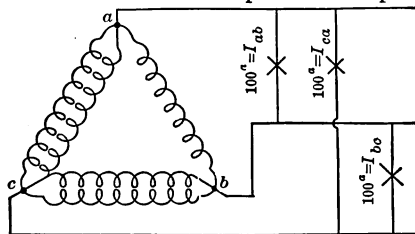

FIG. 153.

Δ -connected transformers of the same type and rating as those connected in V , the combined output of the system will be only $33\frac{1}{3}$ per cent. greater than the capacity of the Δ -connected group, although the total transformer capacity involved is $66\frac{2}{3}$ per

cent. greater. Let Fig. 153 represent the connections of both the primary and the secondary sides of the transformers. On two phases, two transformers are in parallel. A single transformer is connected to the third phase.

Assume a balanced 100-amp. load to be connected between the three pairs of mains. Consider the load on each phase separately. Each will divide among the three branches of the bank of transformers inversely as the impedances of the branches.

The component currents in each phase of the bank of transformers will be:

$$\begin{array}{l}
 I'_{ab} = 50 = \frac{1}{2}I_{ab} \\
 I'_{bc} = 50 = -\frac{1}{2}I_{ab} \\
 I'_{ca} = 50 = -\frac{1}{2}I_{ab}
 \end{array}
 \left. \vphantom{\begin{array}{l} I'_{ab} \\ I'_{bc} \\ I'_{ca} \end{array}} \right\} \begin{array}{l} \text{Due to the 100 amp. be-} \\ \text{tween mains } a \text{ and } b. \end{array}$$

$$\begin{array}{l}
 I''_{ab} = 25 = -\frac{1}{4}I_{bc} \\
 I''_{bc} = 75 = \frac{3}{4}I_{bc} \\
 I''_{ca} = 25 = -\frac{1}{4}I_{bc}
 \end{array}
 \left. \vphantom{\begin{array}{l} I''_{ab} \\ I''_{bc} \\ I''_{ca} \end{array}} \right\} \begin{array}{l} \text{Due to the 100 amp. be-} \\ \text{tween mains } b \text{ and } c. \end{array}$$

$$\begin{array}{l}
 I'''_{ab} = 25 = -\frac{1}{4}I_{ca} \\
 I'''_{bc} = 25 = -\frac{1}{4}I_{ca} \\
 I'''_{ca} = 75 = \frac{3}{4}I_{ca}
 \end{array}
 \left. \vphantom{\begin{array}{l} I'''_{ab} \\ I'''_{bc} \\ I'''_{ca} \end{array}} \right\} \begin{array}{l} \text{Due to the 100 amp. be-} \\ \text{tween mains } c \text{ and } a. \end{array}$$

Phase *ab* of the transformer bank will carry a current equal to

$$I'_{ab} + I''_{ab} + I'''_{ab} = 75$$

The total current in phase *bc* of the transformers will be

$$I''_{bc} + I'''_{bc} + I'_{bc} = 115$$

The total current in phase *ca* of the transformers will be

$$I'''_{ca} + I'_{ca} + I''_{ca} = 115$$

Each of the transformer windings between *b* and *c* and between *c* and *a* will carry $\frac{115}{2} = 57\frac{1}{2}$ amp. The winding between *a* and *b* carries 75 amp. and is, therefore, the one that limits the output. If the delta load is to be 100 amp. as was assumed, the rating of the transformers must be 75 amp. A single group of Δ -connected transformers of this rating would carry a 75-amp. delta load as against a 100-amp. delta load for the Δ - and *V*-connected transformers in parallel. The gain in output obtained by putting the *V* in parallel with the delta is, therefore, $\frac{25}{75} 100 = 33\frac{1}{3}$ per cent.

CHAPTER XXII

RATIO OF TRANSFORMATION, FLUX AND FLUX DENSITY; PRIMARY AND SECONDARY LEAKAGE REACTANCES, EQUIVALENT REACTANCE, PRIMARY AND SECONDARY RESISTANCES CALCULATED FROM THE DIMENSIONS OF A TRANSFORMER; CORE LOSS, COMPONENT OF NO-LOAD CURRENT SUPPLYING CORE LOSS, MAGNETIZING CURRENT AND NO-LOAD CURRENT CALCULATED FROM DIMENSIONS OF TRANSFORMER AND CORE LOSS AND MAGNETIZATION CURVES; EQUIVALENT RESISTANCE AND EQUIVALENT REACTANCE FROM TEST DATA; CALCULATED REGULATION AND EFFICIENCY

The Transformer.—A 300-kv-a. 11,000 to 2300-volt, 60-cycle, core-type, single-phase transformer with a silicon iron core, will be used. The primary and secondary windings each consist of two cylindrical coils connected in series. The two windings are concentric, the high-tension winding being outside. One coil of each winding is placed on each of the two upright legs of the core.

LOW-VOLTAGE WINDING

Total turns.....	190
Turns per coil.....	95
Measured resistance at 25°C. including 9 ft. of leads.....	0.0495 ohm.

Each conductor consists of three rectangular cotton-covered wires in parallel wound on edge three conductors wide. The cross-section of each wire is 0.345×0.100 in.

HIGH-VOLTAGE WINDING

Total turns.....	910
Turns per coil.....	455
Measured resistance at 25°C.....	1.31 ohms.
Cross-section of conductor.....	(0.500×0.045) in.

IRON CORE

The core is built up of sheets of silicon steel 0.014 in. thick. The space factor of the core is 0.9.

The dimensions of the core and of the two windings are given on Fig. 154. The core loss for the iron of the core, the magnetization curve, and curves of impedance voltage and short-circuit loss are plotted in Fig. 155.

Subscripts 1 and 2 when used with letters representing volt-

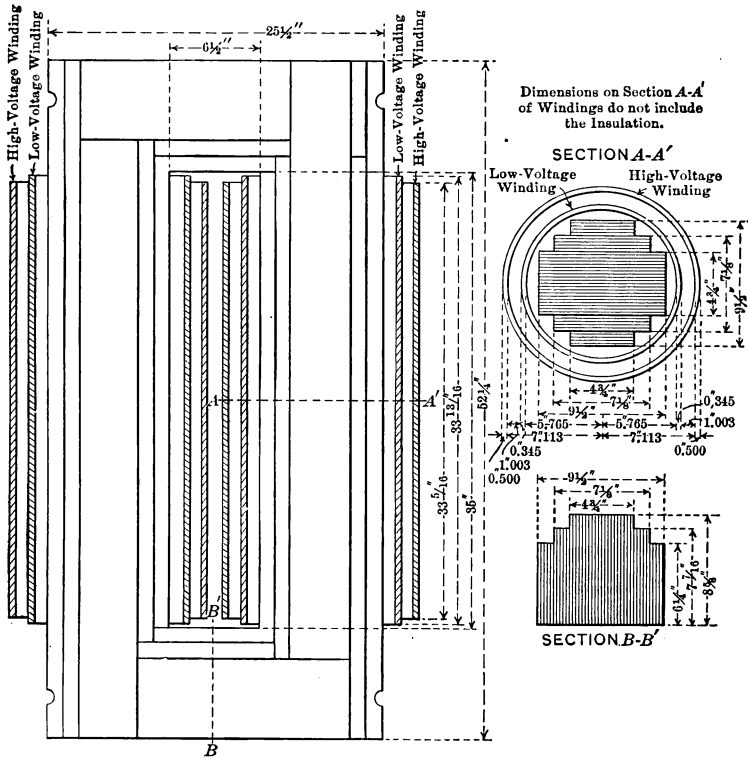

FIG. 154.

age, current, resistance, etc., refer to the high- and low-voltage windings respectively.

Ratio of Transformation.—The true ratio of transformation is the ratio of the voltages induced by the mutual flux. This ratio is the same as the ratio of turns in the two windings. It is

$$\frac{N_1}{N_2} = \frac{910}{190} = 4.79$$

Flux.—From equation (50), page 164, the voltage induced in a transformer is

$$E_2 = 4.44N_2\phi_m f 10^{-8}$$

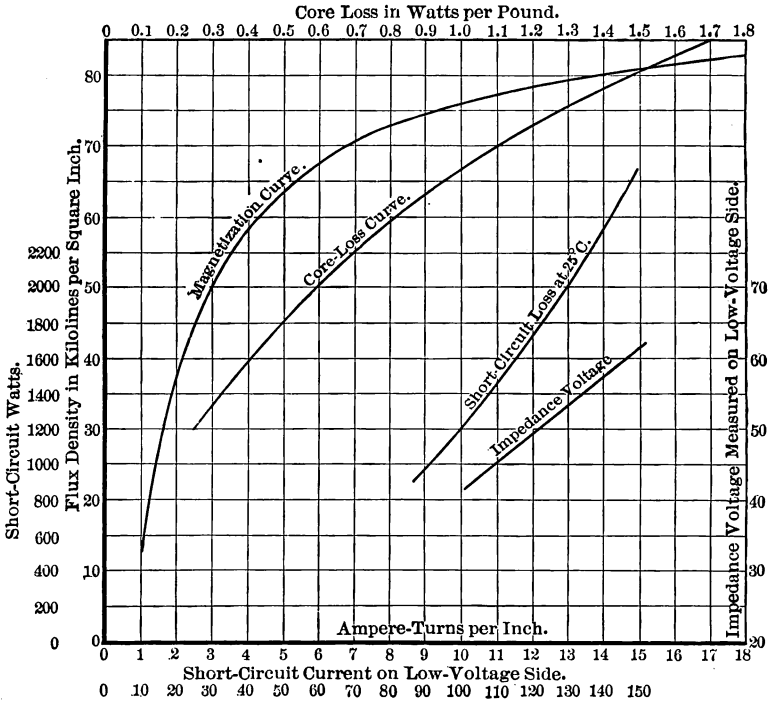

FIG. 155.

Neglecting the primary impedance drop and assuming a sinusoidal voltage

$$\phi_m = \frac{2300 \times 10^8}{190 \times 4.44 \times 60} = 4,540,000 \text{ lines.}$$

Flux Density.—Area of the upright legs of the core is (Fig. 154)

$$(7\frac{1}{8})^2 \times 4(4\frac{3}{4} \times 1\frac{3}{16}) = 73.4 \text{ sq. in.}$$

Area of top or bottom yoke is

$$(6\frac{1}{4} \times 9\frac{1}{2}) + (4\frac{3}{4} + 7\frac{1}{8})1\frac{3}{16} = 73.5 \text{ sq. in.}$$

The space factor for the core is 0.9.

$$\text{Flux density} = \frac{4,540,000}{0.9 \times 73.5} = 68,700 \text{ lines per square inch.}$$

Primary and Secondary Leakage Reactances.—From equations (58) and (59), page 189.

$$x_2 = 2\pi f \left\{ \frac{8\pi^2 N_2^2}{L_2} \left[\frac{d_4 d_2}{3} + \frac{d_2^2}{4} + \frac{1}{2} (d_4 + d_2 + \frac{1}{2} d_3) d_3 \right] \right\} 10^{-9}$$

$$x_1 = 2\pi f \left\{ \frac{8\pi^2 N_1^2}{L_1} \left[\frac{(d_4 + d_2 + d_3) d_1}{3} + \frac{d_1^2}{12} + \frac{1}{2} (d_4 + d_2 + \frac{1}{2} d_3) d_2 \right] \right\} 10^{-9}$$

From Fig. 154.

- $d_4 = 5.765 \text{ in.}$
- $d_2 = 0.345 \text{ in.}$
- $d_3 = 1.003 \text{ in.}$
- $d_1 = 0.500 \text{ in.}$
- $L_1 = 33\frac{5}{16} \text{ in.}$
- $L_2 = 33\frac{3}{16} \text{ in.}$

There are two low-voltage and two high-voltage coils in series on the transformer. All dimensions must be reduced to centimeters.

$$x_2 = 2 \times 2.54 \left\{ 2\pi 60 \frac{8\pi^2 (95)^2}{33\frac{3}{16}} \left[\frac{5.77 \times 0.345}{3} + \frac{(0.345)^2}{4} + \frac{1}{2} \left(5.77 + 0.345 + \frac{1.003}{2} \right) 1.003 \right] \right\} 10^{-9}$$

$$= 0.162 \text{ ohm.}$$

$$x_1 = 2 \times 2.54 \left\{ 2\pi 60 \frac{8\pi^2 (455)^2}{33\frac{5}{16}} \left[\frac{(5.77 + 0.345 + 1.003) 0.500}{3} + \frac{(0.500)^2}{12} + \frac{1}{2} \left(5.77 + 0.345 + \frac{1.003}{2} \right) 1.003 \right] \right\} 10^{-9}$$

$$= 4.24 \text{ ohms.}$$

Equivalent Reactance.—The equivalent leakage reactance referred to the low voltage side is

$$x_e = 0.162 + 4.24 \left(\frac{1}{4.79} \right)^2 = 0.347 \text{ ohm.}$$

Resistance of Low-voltage Winding.—Mean length of turn of the low-voltage winding (Fig. 154) is

$$2\pi\left(5.765 + \frac{0.345}{2}\right) = 37.3 \text{ in.}$$

Cross-section of copper conductor =

$$3(0.345 \times 0.100) = 0.1035 \text{ sq. in.}$$

The specific resistance of copper at 25°C. is 10.42 ohms.

$$\begin{aligned} r_2 &= \frac{37.3 \times 190}{0.1035} \frac{\pi}{4(1000)^2 12} 10.42 \\ &= 0.0467 \text{ ohm.} \end{aligned}$$

Mean length of turn of high-voltage winding (Fig. 154) is

$$2\pi\left(7.11 + \frac{0.500}{2}\right) = 46.3 \text{ in.}$$

Cross-section of copper conductor =

$$\begin{aligned} &0.500 \times 0.045 = 0.0225 \text{ sq. in.} \\ r_1 &= \frac{46.3 \times 910}{0.0225} \frac{\pi}{4(1000)^2 12} 10.42 \\ &= 1.28 \text{ ohms.} \end{aligned}$$

The calculated resistances do not include the resistances of the leads or the effect on the resistance of bending the copper when forming the coils.

Core Loss.—Allowing a space factor of 0.9 for the core, the volume of steel contained in it is

$$2\left\{(52\frac{1}{4} \times 73.4) + (6\frac{1}{2} \times 73.5)\right\} 0.9 = 7780 \text{ cu. in.}$$

The flux density was found to be 68,700 lines per square inch. The loss per pound at this density is (Fig. 155) 1.055 watts.

The density of the silicon steel of the core is 0.26 lb. per cubic inch.

$$\begin{aligned} \text{Total core loss} &= 7780 \times 0.26 \times 1.055 \\ &= 2140 \text{ watts.} \end{aligned}$$

Component of No-load Current Supplying Core Loss.—This is the current marked I_{h+e} on the transformer vector diagrams. Assuming a sine wave of voltage and current

$$I_{h+e} = \frac{2140}{2300} = 0.93 \text{ amp.}$$

This current is on the low-voltage side.

Magnetizing Current.—The magnetizing current can be found from equation (52), page 166, but it is simpler to get it from a magnetization curve plotted with flux densities against ampere-turns per unit length of core. Such a curve is given on Fig. 155.

The maximum flux density in the core was found to be 68,700 lines per square inch. From Fig. 155, 6.35 ampere-turns per inch of length of the iron core are required at that density. The 6.35 is the maximum value of the ampere-turns.

The approximate mean length of the core is

$$2\left\{(6\frac{1}{2} + 9\frac{1}{2}) + (35 + 8\frac{5}{8})\right\} = 119\frac{1}{4} \text{ in.}$$

The root-mean-square ampere-turns for the iron of the core are

$$\frac{1}{\sqrt{2}} 119\frac{1}{4} \times 6.35 = 535$$

The lap joints at the corners of the core must be figured as small air gaps. Each joint of ordinary transformer cores is equivalent to an air gap of about 0.002 in. According to this assumption, the ampere-turns for each joint may be found from equation (52), page 166.

$$\varphi_m = \frac{0.4\pi NI_m}{\frac{l}{a\mu}}$$

Since μ for air is one, this equation may be written

$$N \frac{I_m}{\sqrt{2}} = NI = \frac{\varphi_m}{a} \times \frac{0.002}{2.540} \times \frac{1}{0.4\pi\sqrt{2}} = 0.00044\mathfrak{B}_m$$

where \mathfrak{B}_m is the maximum flux density in lines per square inch and NI is the root-mean-square ampere-turns required per joint.

$$NI = (0.00044)68,700 = 30 \text{ ampere-turns.}$$

The total ampere-turns are, therefore

$$535 + 4 \times 30 = 655$$

The magnetizing current measured on the low-voltage side is

$$I_\varphi = \frac{655}{190} = 3.45 \text{ amp.}$$

The large increase in magnetizing current produced by a moderate increase in the voltage impressed on a transformer may be

seen by referring to Fig. 155. At an impressed voltage of 2300, the flux density in the core was found to be 68,700 lines per square inch. At a voltage 25 per cent. greater than 2300, the flux density would be $68,700 \times 1.25 = 85,900$. The ampere-turns per inch of length of core corresponding to this density are, by extrapolation on the plot, approximately 23. This calls for an increase in the magnetizing current for the iron of the core of $1 - \frac{23}{6.35} = 2.6$ or 260 per cent.

No-load Current.—The no-load current on the low-voltage side is

$$\begin{aligned} I_n &= I_{h+e} + jI_\phi \\ &= 0.93 + j3.45 \\ &= 3.57 \text{ amp.} \end{aligned}$$

Equivalent Resistance From Test Data.—The short-circuit loss at 130.4 amp. from the plot, Fig. 155, is 2020 watts. Therefore, r_e referred to the low-voltage side is

$$r_e = \frac{2020}{(130.4)^2} = 0.119 \text{ ohm.}$$

The equivalent resistance at 25 degrees calculated from the measured resistance is

$$r_e = 0.0495 + 1.31 \frac{1}{(4.79)^2} = 0.107 \text{ ohm.}$$

This last value of r_e does not include certain eddy-current and hysteresis losses which are caused by the leakage flux. For this reason it should be slightly smaller than the value calculated from the short-circuit data.

Equivalent Reactance from Test Data.—The full-load current on the low-voltage side is

$$\frac{300,000}{2300} = 130.4 \text{ amp.}$$

From the plot, Fig. 155, the impedance voltage corresponding to 130.4 amp. is 53.5.

$$\begin{aligned} z_e &= \frac{53.5}{130.4} = 0.41 \text{ ohm.} \\ x_e &= \sqrt{(0.41)^2 - (0.119)^2} = 0.39 \text{ ohm.} \end{aligned}$$

This is referred to the low-voltage side.

The equivalent reactance calculated from the dimensions of the windings was 0.35 ohm.

Regulation.—The regulation will be calculated for a full kilovolt-ampere load of 0.8 power factor and a temperature of 75°C. using the values of x_e and r_e obtained from the test data.

$$r_e = 0.119 \text{ ohm at } 25^\circ\text{C.}, x_e = 0.39 \text{ ohm.}$$

$$r_e \text{ at } 75^\circ\text{C.} = 0.119 (1 + 50 \times 0.00385) = 0.142 \text{ ohm.}$$

From equation (64), page 198.

$$\begin{aligned} \frac{V_1}{a} &= V_2 + I_2(\cos \theta_2 - j \sin \theta_2)(r_e + jx_e) \\ &= 2300 + 130.4(0.8 - j0.6)(0.142 + j0.39) \\ &= 2345.3 + j29.6 \\ &= 2345. \end{aligned}$$

$$\text{Regulation} = \frac{2345 - 2300}{2300} 100 = 1.97 \text{ per cent.}$$

Efficiency.—The efficiency will be calculated at 0.8 power factor. From equation (68), page 207, the efficiency is

$$\frac{V_2 I_2 \cos \theta_2}{V_2 I_2 \cos \theta_2 + P_c + I_2^2 r_e}$$

The core loss corresponding to $V_2 = 2300$ volts has already been found to be 2140 watts. From the plot $I_2^2 r_e$ corresponding to the full-load current, $I_2 = 130.4$, is 2020 watts. This is at 25°C. At 75°C., it is $2020 \times (1 + 50 \times 0.00385) = 2409$ watts.

$$\eta = \frac{300,000 \times 0.8}{300,000 \times 0.8 + 2140 + 2409} 100 = 98.14 \text{ per cent.}$$

SYNCHRONOUS MOTORS

CHAPTER XXIII

CONSTRUCTION; GENERAL CHARACTERISTICS; POWER FACTOR;
V-CURVES; METHODS OF STARTING; EXPLANATION OF THE
OPERATION OF A SYNCHRONOUS MOTOR

Construction.—Synchronous motors are always built with salient poles. In other respects there is no essential difference between their construction and the construction of a synchronous generator. The only differences which exist do not involve principles of design, and are merely to better adapt the machines to the particular purpose for which they are to be used. The chief differences are in the relative amounts of armature reaction and in the damping devices. Any synchronous generator will operate as a synchronous motor and, *vice versa*, any synchronous motor will operate as a synchronous generator, but, as a rule, a synchronous motor will have a more effective damping device to prevent hunting than is necessary for a synchronous generator and its armature reaction will be larger than is desirable for a generator.

General Characteristics.—A synchronous motor will operate at only one speed, *i. e.*, at synchronous speed. This speed depends solely upon the number of poles for which the motor is built and upon the frequency of the circuit from which it is operated. The speed is entirely independent of the load. A change in load is accompanied by a change in phase and in the instantaneous speed, but not by a change in the average speed. If, due to excessive load or any other cause, the average speed differs from synchronous speed, the average torque developed becomes zero and the motor comes to rest. A synchronous motor as such has absolutely no starting torque.

Power Factor.—The power factor of a synchronous motor operating from constant-potential mains is fixed by its field excitation and by the load it carries. At any given load the power factor may be varied over wide limits by altering the field excita-

tion. A motor is said to be over- or under-excited according as its excitation is greater or less than normal. Normal excitation is that which produces unity power factor. Over excitation produces condensive action and causes a motor to take a leading current. An under-excited synchronous motor will take a lagging current. The field current which produces normal excitation depends upon the load and in general, except at very small loads, it increases with the load.

V-Curves.—Since it is possible to operate a synchronous motor at different power factors, curves may be plotted showing the

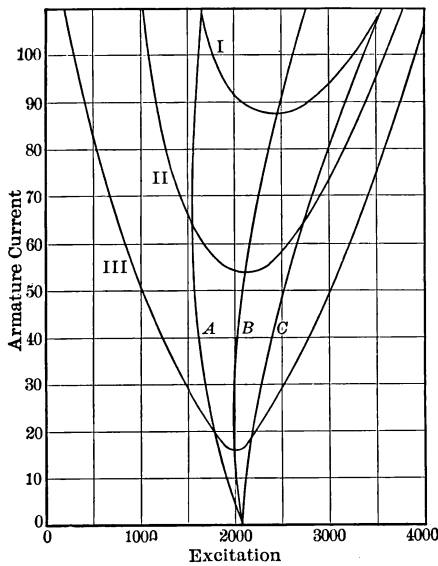

FIG. 156.

relation between the armature or line current and the excitation for different constant loads. Such curves are called V-curves on account of their shape. Lines drawn through points of equal power factor on the V-curves are called compounding curves. Fig. 156 shows three V-curves and three compounding curves of a synchronous motor.

Curves I, II and III are the V-curves for three different loads, and A, B and C are compounding curves. Curve I is for the largest load and curve III is for the smallest load. B is the

compounding curve for unity power factor and gives the normal excitation for different loads.

Methods of Starting.—Since synchronous motors have no starting torque, some auxiliary device must be used to bring them up to speed. Polyphase synchronous motors may be brought up to speed by the induction-motor action produced in their damping windings and by the hysteresis and eddy currents in the pole faces. The field winding is usually open while the motor is being started in this way, but in some cases it is short-circuited. The damping winding usually consists of copper bars which pass through the pole faces near their surface. The ends of these bars are connected together by copper or brass straps. If the synchronous motor is provided with an exciter which is mounted on its shaft, this exciter may be used as a direct-current motor to bring the synchronous motor up to speed. A small induction motor mounted directly on the shaft of the synchronous motor is occasionally used for starting. In this case the induction motor must have fewer poles—usually two less—than the synchronous motor in order that it may bring the synchronous motor up to synchronous speed.

Explanation of the Operation of a Synchronous Motor.—A single-phase motor having a concentrated winding will be considered in order to simplify the explanation. Let the rectangles marked *N* and *S* in Fig. 157 represent the ends of the pole faces and let the rectangle represent the armature winding. The electromotive force induced in the armature winding will be zero for the position of the coil shown. Let the direction of rotation of the motor be such that the armature moves from left to right relatively to the poles. Call an electromotive force positive when it acts in a clockwise direction.

Assume the armature to be driven at a uniform speed. The electromotive force generated in the coil while it moves from left to right is plotted on the reference line *AB* in Fig. 157. Now let the armature circuit be closed through a load of such constants that the current in the coil is in phase with the generated electromotive force. This current is marked *I*. While the coil moves from *a* to *b*, the face of the coil towards the poles will be south. There is, therefore, a force of attraction between it and the pole *a*, and a force of repulsion between it and the

pole *b*. That is, during the movement from *a* to *b*, there is a torque which opposes the motion of the coil. The power developed at any instant is equal to the product of the instantaneous values of the current and the voltage. Since the speed is constant, the torque is also proportional to this product. While the coil moves from *b* to *c* the current and the induced electromotive force both reverse. Their product is still positive and the sign of the torque remains unchanged. The torque curve is marked *T* on the figure. The torque is intermittent but is always positive and since it opposes the motion of the coil, it corresponds to generator action. (The torque of a polyphase generator is the algebraic sum of the torques developed by all

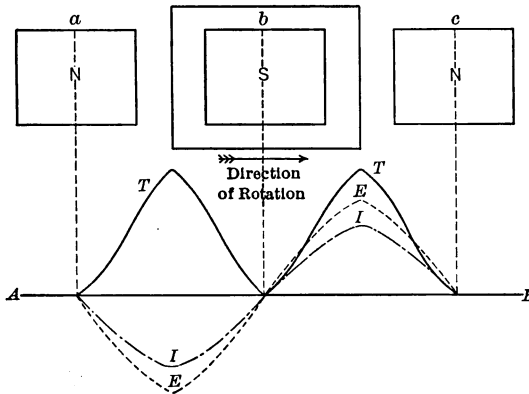

FIG. 157.

phases and is constant if the currents and voltages are sine waves and the impressed voltages and the currents are balanced.)

If the load on the generator is such that the current is not in phase with the generated voltage, the torque curve will have positive and negative loops. The average torque will be proportional to the difference between the areas enclosed by these loops. It will be positive for any angle of lag or lead which is less than 90 degrees. A study of Fig. 157 will show this. This study will also show that a lagging current in the case of a generator will produce a demagnetizing action on the poles and that a leading current will produce the opposite effect.

Suppose that while the generator is running with the current

and the voltage in phase, the current is reversed in some way. This condition is represented in Fig. 158.

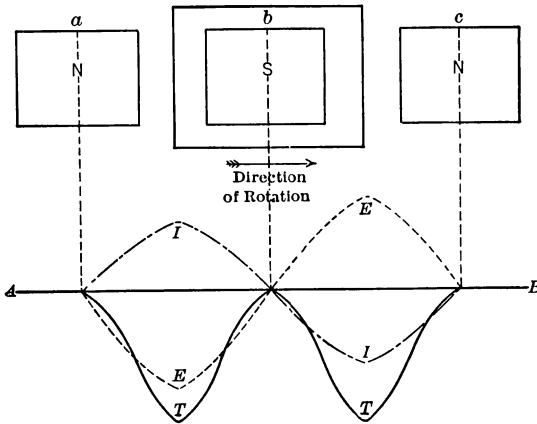

FIG. 158.

The current and the voltage are now exactly 180 degrees apart and their product, which is proportional to the torque, is negative and corresponds to motor action.

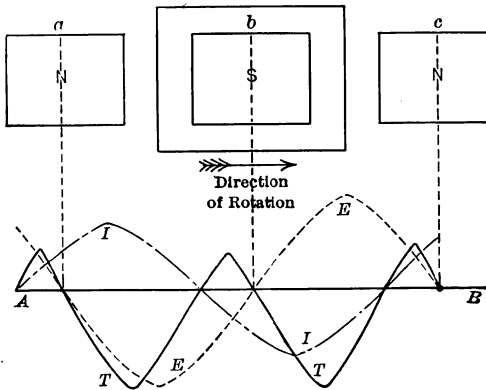

FIG. 159.

The current in the coil while it passes from *a* to *b* is in a clockwise direction and causes the face of the coil toward the poles to be a north pole. There is, therefore, a force of repulsion between

the coil and the pole *a* and a force of attraction between the coil and the pole *b*. The resultant of these two forces assists the motion of the coil and produces motor action. The conditions existing with a leading current are shown in Fig. 159. The torque in this case has positive and negative loops. For angles of lead between zero and 90 degrees, the negative loops are larger than the positive ones and there is a resultant motor torque. The conditions for a lagging current are shown in Fig. 160.

The effect produced on a motor by a lagging or a leading current is just the opposite to that produced by these currents on a generator. The effect of armature reaction depends upon

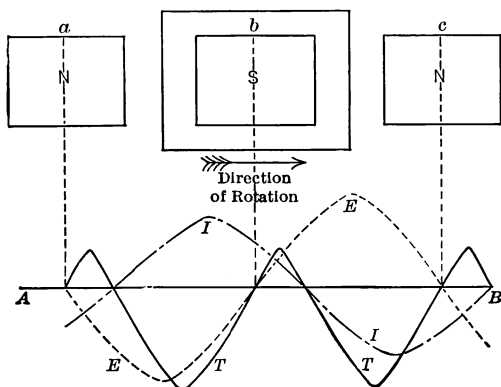

FIG. 160.

the phase relation between the current and the generated voltage. Therefore, since the current of a motor and the current of a generator are nearly opposite in phase with respect to the generated voltage, the effect produced on the field by a leading or a lagging current in a motor is just opposite to the effect produced by similar currents in a generator. A leading current in a motor demagnetizes and a lagging current magnetizes the field. This can easily be seen by referring to Figs. 159 and 160. Consider the case of the lagging current shown in Fig. 160. When the coil is over the pole *b* it is still carrying a positive or clockwise current. This current, according to the cork-screw rule, will cause the face of the coil which is toward the pole *b*

to be a north pole. The magnetomotive force of the coil, therefore, is in the same direction as the magnetomotive force of the field excitation. At constant output, the effect of a change of field excitation is to alter the armature current and hence to change the power factor.

A synchronous motor, unlike a direct-current motor, may be operated with a generated or armature voltage which is considerably greater than the impressed voltage. If it were possible to build a motor without reactance it would not operate except with a generated voltage less than the impressed voltage and even under this condition it would be very unstable.

CHAPTER XXIV

VECTOR DIAGRAM; MAGNETOMOTIVE-FORCE AND SYNCHRONOUS-IMPEDANCE DIAGRAMS; CHANGE IN NORMAL EXCITATION WITH CHANGE OF LOAD; EFFECT OF CHANGE IN LOAD AND FIELD EXCITATION

Vector Diagram.—The same notation will be used as was adopted for the generator. For generator action, there must be a component of the armature current in phase with the generated voltage. For motor action, there must be a component of this current opposite in phase to the armature voltage. The vector diagrams of a synchronous motor and of a synchronous generator are similar. They differ only in the relative positions of the vectors of generated voltage and current and those vectors

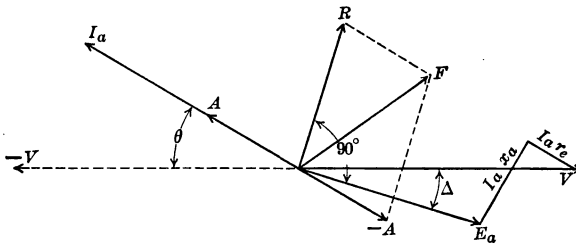

FIG. 161.

which depend upon the current. The vector diagram of a synchronous motor is shown in Fig. 161. Compare this diagram with the vector diagram of a generator shown in Fig. 46, page 86.

V is the rise in voltage through the motor. To get the internal or generated voltage, E_a , the resistance and reactance drops must be added to the voltage V . This corresponds exactly to what was done in the case of the generator. The resultant field, R , leads the generated voltage, E_a , by 90 degrees. The vector sum of R and the magnetomotive force, $-A$, which is required to balance the armature reaction, is equal to the impressed field

F . $-V$ on the diagram is the voltage drop across the motor terminals. The cosine of the angle between this voltage drop and the current, I_a , is the power factor of the motor.

Refer all vectors to V as an axis.

$$\begin{aligned} I_a &= -I_a (\cos \theta - j \sin \theta) \\ E_a &= V + I_a (r_e + jx_a) \\ &= V - I_a (\cos \theta - j \sin \theta) (r_e + jx_a) \\ &= C + jD \end{aligned}$$

R is found from the open-circuit characteristic and corresponds to the voltage E_a on that curve.

$$\begin{aligned} \sin \Delta &= \frac{D}{\sqrt{C^2 + D^2}} \\ \cos \Delta &= \frac{C}{\sqrt{C^2 + D^2}} \\ R &= R (\sin \Delta + j \cos \Delta) \\ -A &= A (\cos \theta - j \sin \theta) \end{aligned}$$

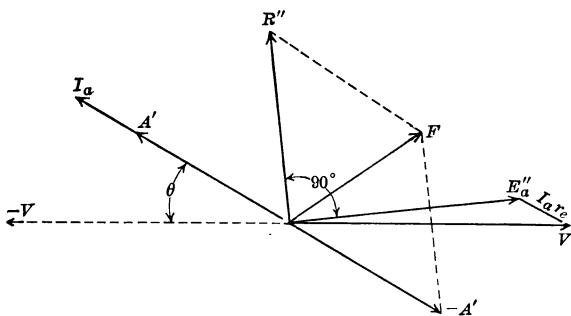

FIG. 162.

The impressed field is the resultant of R and $-A$ and is equal to

$$F = R (\sin \Delta + j \cos \Delta) + A (\cos \theta - j \sin \theta)$$

The electromagnetic power developed by the motor is equal to the current multiplied by the energy component of the generated voltage taken with respect to the current. This is equal to

$$I_a E_a \cos (\theta - \Delta) = I_a \sqrt{C^2 + D^2} \cos (\theta - \Delta)$$

The electromagnetic power is the total internal power developed by the motor. It is equal to the external load plus all rotational losses. These latter include friction and windage and all eddy-current and hysteresis losses due to rotation.

The Magnetomotive-force and the Synchronous-impedance Diagrams.—Either the magnetomotive-force or the synchronous-impedance diagram may be applied to the motor. These two diagrams are shown in Figs. 162 and 163 respectively.

The internal power developed by a motor is always equal to the energy component of the generated voltage, with respect to the current, multiplied by the current. It is immaterial whether the voltage generated by the resultant field, by the impressed field or by R'' on the magnetomotive-force diagram is used, since

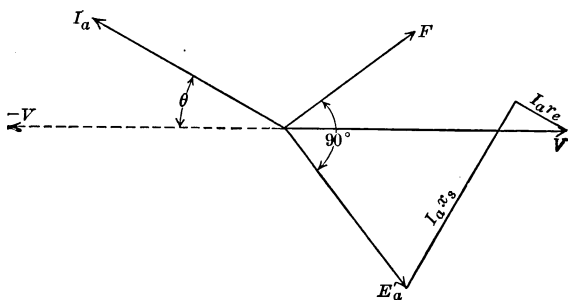

FIG. 163.

the energy components of all three of these with respect to the current are the same.

Change in Normal Excitation with Change of Load.—Under the heading "Power Factor" on page 297, the statement is made that the field current which produces normal excitation increases with the load except for small loads. The reason it should decrease with small loads may be seen from the vector diagram of the synchronous motor. Fig. 164 is the vector diagram of a synchronous motor for unit power factor.

Assuming that the synchronous reactance and effective resistance remain constant, the line $I_a z_s$ on the diagram will make a constant angle with the vector, V , which represents the rise in voltage across the motor terminals. At light loads E'_a and V nearly coincide. As the load is increased, the power factor

remaining unity, the extremity of the vector E_a' travels out along the line ab and will decrease in length until it reaches the position where it is perpendicular to ab . Beyond this position it will increase in length. Since E_a' is the excitation voltage, *i.e.*, the voltage which the impressed field would produce on open circuit, the impressed field will vary in a similar manner. The bottom part of a compounding curve of a synchronous motor will, therefore, be inclined slightly toward low excitation. The point of excitation at which it commences to slope toward higher excitation will be where the vector E_a' becomes perpendicular to $I_a z_s$. This excitation will depend upon the ratio of x_s to r_e . It will usually be well down on the compounding curve and in some cases it may be too far down to show at all. If the motor had no reactance, the field excitation for unity power factor would

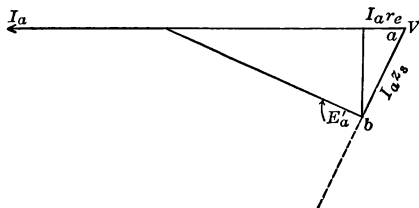

FIG. 164.

decrease continuously with increasing load. On the other hand, if the motor had no resistance, the field excitation under similar conditions would increase continuously.

Effect of Change in Load and Field Excitation.—The current taken by a direct-current motor is equal to $\frac{V - E_a}{r_a} = I_a$. If load is applied the motor slows down and decreases E_a . It will continue to decrease its speed until the current has increased sufficiently to carry the load. The theoretical limit of load can be readily shown to be reached when $E_a = I_a r_a = \frac{1}{2} V$. Beyond this limit the decrease in E_a will more than balance the increase in I_a . If the field excitation is increased, E_a increases, decreasing $V - E_a$ and consequently the current. The power developed by the motor is now too small to carry the load and it will start to slow down. It will continue to slow down until the effect on

E_a of the decrease in speed balances the effect of the increase in the excitation. The current will then have increased to nearly its original value. A direct-current motor adjusts itself to a change in load or in its excitation by changing its speed.

A synchronous motor must run at synchronous speed. It cannot change its *average* speed to accommodate itself to a change in load or in excitation. The current taken by a synchronous motor is equal to

$$I_a = \frac{V - E_a'}{z_s}$$

For any given excitation, E_a' is fixed in magnitude, but its phase relation with respect to V may change and alter the current. A synchronous motor accommodates itself to a change in load by changing the phase of its generated voltage with respect to the voltage impressed across its terminals. Its average speed does not alter but its instantaneous speed changes long enough to permit the required change in phase to take place. If load is applied, it starts to slow down and will continue to slow down until sufficient change in phase has been produced. If the motor is not properly damped, it may over-run and develop too much power. It will then speed up and may again over-run. It will now be developing too little power and the action will be repeated. This is called hunting. Hunting will be taken up later somewhat in detail. If the field excitation is altered, E_a' and the power developed will change. The motor will then immediately alter its phase until equilibrium has been re-established.

An increase in load on a synchronous motor always produces a momentary decrease in speed and causes the generated voltage to swing in the direction of lag. In other words, it increases the lag of the generated voltage with respect to the impressed voltage. A decrease in load produces the opposite effect. A change in the field excitation of a synchronous motor also produces a momentary change in speed which is accompanied by a change in phase between the generated and terminal voltages. In general, an increase in the excitation will cause a momentary increase in speed and a permanent advance in phase of the generated voltage.

CHAPTER XXV

MAXIMUM AND MINIMUM MOTOR EXCITATION FOR FIXED MOTOR POWER AND FIXED IMPRESSED VOLTAGE; MAXIMUM MOTOR POWER WITH FIXED E_a' , V , r_e AND x_s ; MAXIMUM POSSIBLE MOTOR EXCITATION WITH FIXED IMPRESSED VOLTAGE AND FIXED RESISTANCE AND REACTANCE; MAXIMUM MOTOR ACTIVITY WITH FIXED IMPRESSED VOLTAGE AND FIXED REACTANCE AND RESISTANCE

Maximum and Minimum Motor Excitation for Fixed Motor Power and Fixed Impressed Voltage.—The synchronous reactance and effective resistance will be assumed constant. Refer all vectors to V as an axis. Small letters will be used

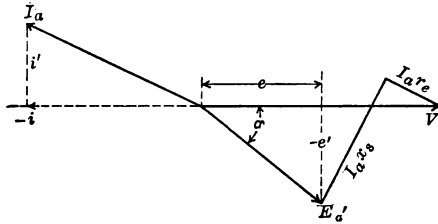

FIG. 165.

to represent components. A prime on a small letter indicates that it is a component which is in quadrature with V , the axis of reference. The synchronous reactance and effective resistance will be represented, respectively, by x_s and r_e . P_m will represent the internal motor power. The synchronous impedance vector diagram is shown in Fig. 165.

Referring to Fig. 165.

$$\begin{aligned} V &= v + j0 \\ E_a' &= e - j e' \\ I_a &= -i + j i' \end{aligned} \tag{88}$$

The resultant voltage causing the current is equal to the impedance drop and is equal to

$$\begin{aligned} E_o &= E_a' - V^* \\ I_a &= \frac{E_o}{z_s} \\ &= \frac{e - je' - v}{r_e + jx_s} \end{aligned}$$

Rationalized, this becomes

$$= \frac{(r_e e - r_e v - x_s e') + j(x_s v - x_s e - r_e e')}{r_e^2 + x_s^2} \quad (89)$$

The power in any circuit is equal to the product of the real parts of the current and the voltage plus the product of the imaginary parts of the current and the voltage.

$$\begin{aligned} P_m &= \frac{e(r_e e - r_e v - x_s e') - e'(x_s v - x_s e - r_e e')}{r_e^2 + x_s^2} \\ &= \frac{r_e(e^2 + e'^2) - v(r_e e + x_s e')}{r_e^2 + x_s^2} \\ &= \frac{r_e E_a'^2 - v(r_e e + x_s e')}{r_e^2 + x_s^2} \quad (90) \end{aligned}$$

For the condition of fixed motor power, the numerator of the expression for the motor power, *i.e.*, the numerator of equation (90) must be constant.

Replace e' in the numerator of equation (90) by its value from equation (88).

$$e' = \sqrt{E_a'^2 - e^2}$$

Putting this in equation (90) gives

$$P_m = \frac{r_e E_a'^2 - v(r_e e + x_s \sqrt{E_a'^2 - e^2})}{r_e^2 + x_s^2} \quad (91)$$

Since the motor power is constant, the differential of P_m with respect to e will be zero.

$$\begin{aligned} 2r_e E_a' \frac{dE_a'}{de} - vr_e - vx_s \frac{E_a' \frac{dE_a'}{de} - e}{\sqrt{E_a'^2 - e^2}} &= 0 \\ \frac{dE_a'}{de} \left\{ 2r_e E_a' - \frac{vx_s E_a'}{\sqrt{E_a'^2 - e^2}} \right\} - v \left\{ r_e - \frac{x_s e}{\sqrt{E_a'^2 - e^2}} \right\} &= 0 \end{aligned}$$

*The voltage, V , on the diagram is the rise in voltage through the motor. The current is in the general direction of the voltage drop, *i.e.*, $-V$.

$$\begin{aligned} \frac{dE_a'}{de} &= \frac{v \left\{ r_c - \frac{x_s e}{\sqrt{E_a'^2 - e^2}} \right\}}{2r_c E_a' - \frac{vx_s E_a'}{\sqrt{E_a'^2 - e^2}}} = 0 \\ v \left\{ r_c - \frac{x_s e}{\sqrt{E_a'^2 - e^2}} \right\} &= 0 \\ vr_c \sqrt{E_a'^2 - e^2} &= x_s e v \\ r_c^2 E_a'^2 - r_c^2 e^2 &= x_s^2 e^2 \\ e &= \frac{r_c E_a'}{\sqrt{r_c^2 + x_s^2}} = \frac{r_c E_a'}{z_s} \end{aligned} \quad (92)$$

Substituting the value of e from equation (92) in equation (91) and replacing $(r_c^2 + x_s^2)$ by z_s^2 gives

$$\begin{aligned} P_m z_s^2 &= r_c E_a'^2 - \frac{vr_e^2 E_a'}{z_s} - vx_s \sqrt{E_a'^2 - \frac{r_e^2 E_a'^2}{z_s^2}} \\ &= r_c E_a'^2 - \frac{vr_e^2 E_a'}{z_s} - \frac{vx_s^2 E_a'}{z_s} \\ &= r_c E_a'^2 - vz_s E_a' \end{aligned}$$

and

$$E_a' = \frac{z_s}{2r_c} \left\{ v \pm \sqrt{4P_m r_e + v^2} \right\}$$

but $v = V$, therefore,

$$E_a' = \frac{z_s}{2r_c} \left\{ V \pm \sqrt{4P_m r_e + V^2} \right\} \quad (93)$$

When substituting the numerical value of the motor power in equation (93), it must be remembered that motor power is negative according to the direction of the vectors for motor current and voltage given on Fig. 165.

The maximum possible motor excitation is when the motor power is zero; therefore, from equation (93)

$$\text{maximum } E_a' = \frac{Vz_s}{r_c}$$

The minimum excitation is zero.

Maximum Motor Power with Fixed E_a' , V , r_e and x_s .—The motor power must be negative. Therefore, since the first term of equation (90) is constant, the second must be negative for

maximum motor power. For a maximum motor power $r_c e + x_s e'$ must be a maximum.

$$\frac{d}{de} (r_c e + x_s e') = r_c + x_s \frac{de'}{de} = 0 \tag{94}$$

$$\begin{aligned} E_a'^2 &= e^2 + e'^2 = \text{constant} \\ \frac{dE_a'^2}{de} &= 2e + 2e' \frac{de'}{de} = 0 \end{aligned} \tag{95}$$

Combining equations (94) and (95) gives

$$\begin{aligned} \frac{d}{de} (r_c e + x_s e') &= r_c - x_s \frac{e}{e'} = 0 \\ \frac{r_c}{x_s} &= \frac{e}{e'} \end{aligned} \tag{96}$$

That is, with the impressed voltage constant and the motor voltage, E_a' , as well as the resistance and the reactance fixed, the maximum motor power will occur when the angle of lag of E_a' behind V is equal to $\tan^{-1} \frac{x_s}{r_c}$.

Putting the value of e' from equation (96) in equation (90) gives

$$\begin{aligned} \text{maximum } P_m &= \frac{r_c E_a'^2 - v \left\{ r_c e + \frac{x_s^2}{r_c} e \right\}}{z_s^2} \\ &= \frac{r_c E_a'^2}{z_s^2} - \frac{ve}{r_c} \end{aligned}$$

But $v = V$, therefore,

$$\begin{aligned} \text{maximum } P_m &= \frac{r_c E_a'^2}{z_s^2} - \frac{VE}{r_c} \\ E_a'^2 &= e^2 + e'^2 \end{aligned} \tag{97}$$

and from equation (96)

$$e' = e \frac{x_s}{r_c}$$

therefore,

$$\begin{aligned} e^2 &= E_a'^2 - e^2 \left(\frac{x_s}{r_c} \right)^2 \\ e &= \frac{E_a' r_c}{z_s} \end{aligned}$$

Substituting this value of e in equation (97) gives

$$\text{maximum } P_m = \frac{E_a'^2 r_c}{z_s^2} - \frac{VE_a'}{z_s} \tag{98}$$

A synchronous motor cannot operate with an excitation voltage greater than the impressed voltage unless it has reactance. This follows from equation (98). If the reactance is zero, equation (98) becomes

$$\text{maximum } P_m = \frac{E_a'^2}{r_e} - \frac{VE_a'}{r_e}$$

For any value of E_a' greater than V , P_m will be positive and will represent generator action.

Maximum Possible Motor Excitation with Fixed Impressed Voltage and Fixed Resistance and Reactance.—In order that the machine shall run as a motor P_m must be negative. The limiting value of E_a' will be that value which makes P_m zero.

$$\begin{aligned} \text{Maximum } P_m &= \frac{E_a'^2 r_e}{z_s^2} - \frac{VE_a'}{z_s} = 0 \\ \frac{E_a'^2 r_e}{z_s^2} &= \frac{E_a' V}{z_s} \\ E_a' &= \frac{V z_s}{r_e} \end{aligned}$$

The maximum possible motor voltage is equal to the impressed voltage multiplied by the ratio of the impedance to the resistance.

Maximum Motor Activity with Fixed Impressed Voltage and Fixed Reactance and Resistance.—

$$\begin{aligned} \frac{dP_m}{dE_a'} &= 0 = \frac{d}{dE_a'} \left\{ \frac{E_a'^2 r_e}{z_s^2} - \frac{E_a' v}{z_s} \right\} \\ \frac{2E_a' r_e}{z_s^2} &= \frac{v}{z_s} \\ E_a' &= \frac{v z_s}{2r_e} = \frac{V z_s}{2r_e} \end{aligned}$$

The maximum motor power, therefore, occurs when the motor voltage has one-half of its maximum possible value. This corresponds to Jacobi's law for a direct-current motor operating with a constant field.

Substituting the value of E_a' just found in equation (98) gives

$$P_m = -\frac{V^2}{4r_e}$$

This is the greatest possible motor power.

CHAPTER XXVI

HUNTING; DAMPING; STABILITY; METHODS OF STARTING SYNCHRONOUS MOTORS

Hunting.—All synchronous machines in which a change in load is accompanied by a change in phase are subject to hunting. Consider the case of a synchronous motor operating under constant excitation and load. Under this condition there will be a perfectly definite phase angle between the impressed and excitation voltages. Suppose the load it carries is increased. The motor will now be developing less power than is demanded by the load and, as a result, it will immediately start to slow down. It will continue to slow down, thereby changing its phase, until the phase displacement between its impressed and excitation voltages corresponds to that required for the load. This slowing down may last several cycles, but unless the load exceeds the maximum load the motor can carry, the change in speed will not last long enough to produce more than a moderate change in phase. This change in phase can never equal 90 electrical degrees, unless the excitation is changed. If the change in phase should exceed that which corresponds to the maximum load the motor will carry, the motor will “break down,” *i.e.*, fall out of synchronism and come to rest. While the motor is slowing down, the increase in load is being supplied by the change in the kinetic energy of the moving part of the motor. At the instant the motor passes through the phase displacement corresponding to the load, the electromagnetic power developed will be equal to the entire load plus the rotational losses of the motor. Due to the inertia of the rotor it cannot instantly take up synchronous speed at this instant. It will therefore over-run. It will now be developing more power than is required for the load and the rotational losses, and it will start to speed up. If it again over-runs it will be developing too little power and it will immediately start to slow down. This action is called hunting. It is equivalent to an oscillation in speed which is superposed on

a uniform speed of rotation. A slight amount of hunting must always take place when the load on a synchronous motor is changed but, with a properly designed motor operating under good conditions, it should be small and not noticeable. In the case of a poorly designed motor or a motor operating under bad conditions, hunting may become excessive.

The effect of hunting will be made clear by a vector diagram. Fig. 166 is a vector diagram of a synchronous motor to which the drop in voltage, $-V$, across the terminals has been added.

The resultant voltage, $E_o = I_a z_s$, which causes the current, I_a , in the circuit, is equal to the vector sum of $-V$ and E_a' . The current, I_a , is equal to this voltage divided by the syn-

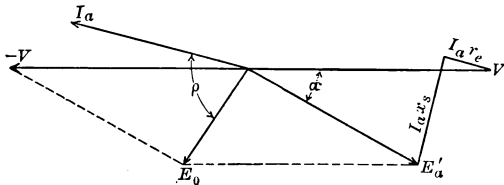

FIG. 166.

chronous impedance of the motor and lags by an angle $\rho = \tan^{-1} \frac{x_s}{r_e}$ behind the voltage E_o . This angle, ρ , would be constant if x_s and r_e were constant.

If hunting takes place, the extremity of the vector E_a' will oscillate on the arc of a circle about its mean position. At the same time E_o and also I_a will change in magnitude and in phase.

The effect of hunting on Fig. 166 is shown in Fig. 167. The full lines on this figure represent the stable condition and the dotted and dot-and-dash lines represent the two extreme displacements due to hunting. The position of the vectors, $-V$ and V , representing the impressed voltage, does not change.

The vector E_a' is assumed to oscillate from a to b . The resultant voltage E_o oscillates from c to d and at the same time changes its magnitude. The current, I_a , is proportional to E_o at every instant and will swing through an angle equal to the angle through which E_o moves. The minimum power is developed when E_a' is ahead of its mean position and has its greatest displacement. This power is equal to the projection of the

motor voltage, Oa , on the current, Og , multiplied by that current. The maximum power is developed when the motor has its extreme displacement in the direction of lag. This is equal to the product of the current, Of , and the projection of the motor voltage, Ob , on that current. It will be seen that there may be a large variation in the power developed if hunting occurs.

The rotating part of the motor acts like a torsional pendulum where the change in the couple producing rotation corresponds to the torsional couple in the fiber or supporting wire of the pendulum. In the case of the motor, the change in the couple is caused by the displacement of the rotor from its mean position.

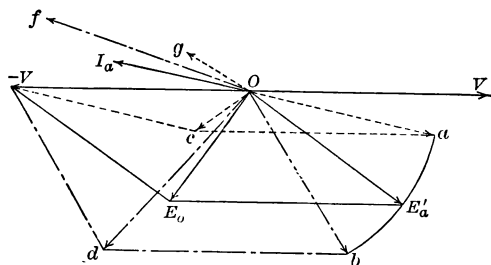

FIG. 167.

The moment of inertia of the rotor corresponds to the moment of inertia of the mass of the pendulum.

$$t = 2\pi \sqrt{\frac{\Sigma md^2}{M}} \quad (99)$$

where t , Σmd^2 and M are respectively, the time of an oscillation, the moment of inertia of the rotor and the restoring couple per unit of angular displacement from the mean position.

From equation (90), page 310, the electromagnetic power developed by a motor is

$$P_m = \frac{r_e E_a'^2 - v(r_e e + x_s e')}{z_s^2}$$

Replacing v by V and e and e' by their values in terms of the angle, α , between E_a' and V (Fig. 165, page 309) gives,

$$P_m = \frac{r_e E_a'^2 - V E_a' (r_e \cos \alpha + x_s \sin \alpha)}{z_s^2} \quad (100)$$

To make equation (100) apply to a polyphase motor, it must be multiplied by the number of phases, n .

If p and f are, respectively, the number of poles on the motor and the frequency, the electromagnetic torque developed by a polyphase motor is

$$T = n \frac{p}{4\pi f} P_m = n \frac{p}{4\pi f} \left\{ \frac{r_e E_a'^2 - V E_a' (r_e \cos \alpha + x_s \sin \alpha)}{z_s^2} \right\} \quad (101)$$

M in equation (99) is equal to the derivative of T with respect to α' , where α' is the displacement in space radians of E_a' from V .

The angle α in equation (101) is in electrical radians.

Therefore, since $\alpha = \frac{p}{2} \alpha'$

$$M = \frac{dT}{d\alpha'} = \frac{np^2 V E_a'}{8\pi f z_s^2} (r_e \sin \alpha - x_s \cos \alpha)$$

The moment, M , is negative, since, according to the convention adopted for motor power, motor power is negative. Before substituting M in equation (99) its sign should be reversed in order to make it positive and avoid an imaginary value for the time of oscillation, t .

Substituting this value of $-M$ in equation (99) gives for the period of hunting, in seconds, of a polyphase synchronous motor,

$$t = 2\pi \sqrt{\frac{8\pi f z_s^2 \Sigma m d^2}{np^2 V E_a' (x_s \cos \alpha - r_e \sin \alpha)}} \quad (102)$$

V , E_a' , z_s , x_s and r_e in equation (102) are per phase and are in c.g.s. units. If practical units are to be used in place of c.g.s. units, the expression under the square-root sign must be multiplied by 10^{-7} .

Equation (102) is only approximate as it neglects the effect of damping due to currents induced by the hunting in the field winding, in the pole faces and in the damping bridges with which all synchronous motors are provided. One effect of these induced currents is to diminish the apparent reactance of the motor.

If the free period of the hunting, as given by equation (102), coincides or nearly coincides with any periodic variation in the

load or in the frequency of the power supplied to the motor, the effect will be cumulative and violent hunting will occur, which, unless damped out, will probably cause the motor to swing beyond the phase displacement corresponding to the maximum power and to drop out of synchronism and come to rest. The maximum possible phase displacement at which the motor can operate has already been shown to occur when $\tan \alpha = \frac{x_s}{r_e}$ (equation 96). This angle for maximum power may also be derived by differentiating equation (100) with respect to α and equating the differential to zero.

$$\begin{aligned} \frac{dP_m}{d\alpha} &= - \frac{VE_a'}{z_s^2} (x_s \cos \alpha - r_e \sin \alpha) = 0 \\ x_s \cos \alpha &= r_e \sin \alpha \\ \tan \alpha &= \frac{x_s}{r_e} \end{aligned}$$

It will be seen from equation (102) that the period of oscillation of a synchronous motor about its mean angular position depends upon the excitation voltage, E_a' , and the phase displacement, α , of this voltage from the voltage impressed on the motor. Consequently, the period depends upon the excitation of the motor and the load it carries. Therefore, if there is any periodic variation in the load, in the impressed voltage or in the excitation, hunting may occur at some load or at some excitation and not at others.

Damping.—There are two ways by which hunting may be diminished. One of these is to increase the moment of inertia of the rotor by increasing its mass by adding a flywheel. This method is applicable to either single or polyphase motors. The other consists of using a short-circuited low-resistance winding, an amortisseur or damping winding or damper as it is called, placed in the pole faces. When an amortisseur winding is used on a single-phase motor, double-frequency currents are induced in it by the double-frequency flux variation produced by armature reaction in the poles (see page 59, under Synchronous Generators). This double-frequency current increases the copper loss in the damper and tends to damp out the flux variation which causes it. Its existence is not dependent upon hunting.

Adding a flywheel may decrease the tendency to hunt by making the free period of oscillation of the motor lower than any which is likely to start hunting. This is an effective way to diminish the tendency to hunt but it does not diminish this tendency by real damping action. Flywheels are not used to decrease hunting, mainly on account of their weight, except in special cases. An amortisseur winding or damper exerts a real damping action. Such windings are universally employed on polyphase synchronous motors. Besides effectively diminishing hunting, they very greatly increase the starting torque of a synchronous motor when it is started as an induction motor.

An amortisseur winding or damper usually takes the form of copper grids placed in the pole faces and copper bridges between

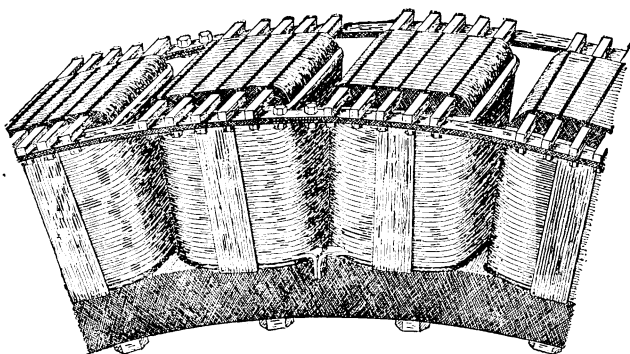

FIG. 168.

the poles. The grids are usually made by placing copper bars in the pole faces near their surfaces and then short-circuiting these bars by bolting or welding them to end straps of brass or copper. An amortisseur winding is shown in Fig. 168.

For the most effective damping, the damper should have as low a resistance as possible, but if this winding is to be used for starting the motor, the resistance which gives the best damping action may be too low to give the best starting torque.

The armature reaction of a polyphase synchronous motor, which operates under steady conditions is fixed in space phase with respect to the poles. Under this condition, the resultant flux is also fixed with respect to the poles and the damper is

inactive and produces no effect whatsoever upon the operation of the motor. When, however, hunting starts, the armature reaction is no longer constant or fixed in space phase with respect to the poles, but sweeps back and forth across them with a period equal to the period of oscillation of the rotor. This causes the resultant flux to cut the damper and to induce currents in it. Eddy-current and hysteresis losses will be produced in the pole faces which will assist, to a slight extent, in damping out the hunting. The main damping action is due to the currents induced in the damper which are in such a direction as to oppose the change in the angular velocity of the rotor which produces them. The reactance of the damping winding for the period of the current induced in it by hunting is very small. Assuming it to be zero, the damping action would be a maximum when the rotor swings through its mean position, and zero when it has its extreme displacement. The effect of damping produced in this way is much the same as the damping produced by a viscous fluid on a torsional pendulum. The braking action produced by a damper is only in part due to the energy dissipated in copper loss in the damping winding. On account of the reaction between the currents in the damper and the armature winding, energy will be returned to the line while the rotor is accelerating and taken from the line while the rotor is retarding.

Due to the reaction of the currents induced in the damper and in the field windings on the armature winding, the apparent reactance of the armature will be slightly diminished when hunting starts. This reaction is similar to the reaction existing between the primary and secondary windings of a transformer when the secondary is loaded. This decrease in the apparent reactance of the motor will slightly decrease the free period of oscillation of the rotor, according to equation (102).

If an amortisseur winding or damper is used on a single-phase synchronous motor, there will be currents induced in it even when the motor is entirely free from hunting. These currents are caused by the armature reaction which, in a single-phase synchronous motor, is neither constant in space phase nor in magnitude. The main effect of a short-circuited winding on a single-phase synchronous machine is to damp out any harmonics

there may be in its wave form. The copper loss of such a winding will considerably lower the efficiency.

The armature reaction of the single-phase motor may be resolved into two revolving vectors, rotating in opposite directions. One of these will be stationary with respect to the rotor, while the other will revolve at twice synchronous speed with respect to it. The component which is fixed with respect to the rotor will produce no effect on the damper; the other, however, will produce double-frequency currents in it. These currents will not be very large on account of the relatively high reactance of the damper to the double-frequency currents.

The width of the air gap and the magnitude of the leakage reactance have a large influence on the stiffness of coupling of a motor. By stiffness of coupling is meant the tendency of a motor to follow every irregularity in the speed of the generators from which it is operated. The degree of stiffness of coupling depends upon the change in power produced by a given change in phase between the impressed voltage and the voltage corresponding to the field excitation. This change in power is determined mainly by the change in the armature current caused by the change in phase.

Since

$$I = \frac{V - E_a'}{z_s}$$

this change in current is fixed by the synchronous impedance, z_s , of the armature. The magnitude of the part of the synchronous reactance which replaces the effect of armature reaction depends upon the effect produced by armature reaction on the field strength. This is greatest when the air gap is small. A small air gap, therefore, makes the synchronous reactance large and, conversely, a large air gap makes the synchronous reactance small. Therefore, a large air gap and low leakage reactance will give a stiff coupling, *i.e.*, the motor will tend to follow every irregularity in the speed of the generator. A small air gap and large leakage reactance will produce what is known as a soft coupling. With too stiff a coupling, a motor will tend to follow the generator too closely and will be subjected to shocks and strains of considerable magnitude whenever irregularities occur in the load, excitation or speed of the system. With too

soft a coupling, there will not be sufficient stability and there will be danger of a motor dropping out of step when any sudden change occurs in the system. A compromise between the two extreme conditions must be made. An objection to a soft coupling is that, under the condition of constant excitation, there will be a large variation in the power factor from no load to full load. An inspection of the vector diagram given in Fig. 164, page 307, should make this clear.

What has just been said in regard to stiffness of coupling neglects the effect of the damper and any damping action that may be produced by eddy-current or hysteresis losses in the pole faces. The damping action of pole-face losses and of a damping winding increases as the width of the air gap is decreased since the smaller the air gap the larger is the effect of armature reaction and the greater is the magnitude of the current induced by it in the damper and pole faces when there is a change in phase between the impressed and excitation voltages.

Stability.—According to equation (98), the maximum electromagnetic power developed by a synchronous motor operating with fixed excitation and fixed impressed voltage may be written

$$\text{maximum } P_m = \frac{r_e E_a'^2}{r_e^2 + x_s^2} - \frac{V E_a'}{\sqrt{r_e^2 + x_s^2}} \quad (103)$$

To find the value of x_s which will make the power a maximum when r_e , V and E_a' are fixed, differentiate equation (103) with respect to x_s and equate the derivative to zero.

$$\frac{d}{dx_s} \left\{ \frac{r_e E_a'^2}{r_e^2 + x_s^2} - \frac{V E_a'}{\sqrt{r_e^2 + x_s^2}} \right\} =$$

$$\frac{-2x_s r_e E_a'^2}{(r_e^2 + x_s^2)^2} + \frac{1/2 \sqrt{r_e^2 + x_s^2} 2x_s V E_a'}{(r_e^2 + x_s^2)^2} = 0$$

$$-2x_s r_e E_a'^2 + \sqrt{r_e^2 + x_s^2} x_s V E_a' = 0$$

$$r_e E_a' = \frac{V}{2} \sqrt{r_e^2 + x_s^2}$$

$$4r_e^2 E_a'^2 = V^2 (r_e^2 + x_s^2)$$

$$x_s^2 = r_e^2 \left(\frac{4E_a'^2 - V^2}{V^2} \right)$$

If V and E_a' are equal,

$$x_s = r_e \sqrt{3}$$

for a maximum motor power. This corresponds to a difference in phase between the impressed and excitation voltages of $\tan^{-1} = \sqrt{3}$ or 60 degrees (equation 96, page 312). This is the phase displacement at which "breakdown" will occur. Since the field excitation of synchronous motors is usually adjusted to make them operate at unity power factor or with a leading current at full load, E_a' will generally be at least equal to V . Therefore, in order to get the maximum possible output from a motor under such conditions, the ratio $\frac{x_s}{r_e}$ should be equal to or somewhat greater than 1.73. A motor, of course, can never be used at an output approaching its maximum, since, under this condition, any hunting would be likely to increase the phase displacement between V and E_a' beyond its limiting value and cause the motor to break down. Increasing the ratio $\frac{x_s}{r_e}$ beyond the value which gives the maximum output, will decrease the maximum output, but it will at the same time increase the displacement at which the maximum output occurs.

For maximum stability, the change in the power developed should be a maximum for a given change in phase. In other words, $\frac{dP_m}{d\alpha}$ should be a maximum. Differentiating the expression for motor power given by equation (100), page 316, with respect to α gives

$$\frac{dP_m}{d\alpha} = \frac{VE_a'(r_e \sin \alpha - x_s \cos \alpha)}{r_e^2 + x_s^2} \quad (104)$$

$\frac{dP_m}{d\alpha}$ might be called the *stability factor*. It will be seen from equation (104) that this stability factor is directly proportional to E_a' , the excitation voltage. An over-excited synchronous motor is, therefore, more stable than one operating under-excited. The maximum power occurs when $\tan \alpha = \frac{x_s}{r_e}$. Substituting the values of $\sin \alpha$ and $\cos \alpha$ corresponding to this in equation (104) makes $\frac{dP_m}{d\alpha}$ zero as it should. For any value of $\tan \alpha$ greater than $\frac{x_s}{r_e}$, $\frac{dP_m}{d\alpha}$ becomes positive and, since motor power is negative according to the notation adopted, it represents

a decrease in motor power. If, therefore, $\tan \alpha$ exceeds $\frac{x_s}{r_e}$, the motor will break down.

The relative magnitudes of r_e and x_s which make the stability factor a maximum can be found by equating the derivative of $\frac{dP_m}{d\alpha}$ with respect to x_s to zero.

$$\begin{aligned} \frac{d}{dx_s} \left\{ \frac{dP_m}{d\alpha} \right\} &= \frac{d}{dx_s} \left\{ \frac{VE_a' (r_e \sin \alpha - x_s \cos \alpha)}{r_e^2 + x_s^2} \right\} \\ &= VE_a' \frac{2x_s^2 \cos \alpha - (r_e^2 + x_s^2) \cos \alpha - 2r_e x_s \sin \alpha}{(r_e^2 + x_s^2)^2} = 0 \\ x_s^2 \cos \alpha - r_e^2 \cos \alpha - 2r_e x_s \sin \alpha &= 0 \\ \frac{x_s}{r_e} &= \tan \alpha \pm \sqrt{1 + \tan^2 \alpha} \end{aligned} \quad (105)$$

The minus sign before $\sqrt{1 + \tan^2 \alpha}$ in equation (105) has no significance, since x_s cannot be negative. The ratio of $\frac{x_s}{r_e}$, given by equation (105) for values of $\tan \alpha$ equal to or greater than $\frac{x_s}{r_e}$, is of no importance since it represents unstable operation.

The ratio of $\frac{x_s}{r_e}$ for maximum stability is unity for $\alpha = 0$, and increases with an increase in α . For $\alpha = 30$ degrees, $\frac{x_s}{r_e}$ for maximum stability should be 1.7; for $\alpha = 45$ degrees, $\frac{x_s}{r_e}$ should be 2.4. The angles of breakdown corresponding to these are, respectively, 60 and 67 degrees.

All that which has preceded on stability is only approximate, as it neglects the effect of the damping, and also the effect of the free period of oscillation of the motor as a torsional pendulum. The usual value of the ratio of $\frac{x_s}{r_e}$ for a synchronous motor is much greater than the values of the ratio deduced for maximum output and maximum stability. Moreover, the steadiness of operation of a motor, which shows a tendency to hunt, is often improved by adding reactance to its circuit. The effect of increasing the reactance is to increase the time of the free period of oscillation as a pendulum, and make it longer

than the period of the disturbance which is causing the hunting. It is usually more important to have the free period quite different from the period of any disturbance which is likely to produce hunting. It is not particularly important to have the natural tendency to damp out oscillations a maximum since this is always supplemented by the strong damping action of the amortisseur winding. If the stability is too great, severe strains will be put on the motor when sudden disturbances occur in the system. In other words, the stiffness of coupling will be too great (see page 321).

Methods of Starting Synchronous Motors.—A synchronous motor may be started by means of an auxiliary motor. When started in this way it is brought up to speed and synchronized like an alternating-current generator. When a synchronous motor is provided with an exciter which is mounted on its shaft, the exciter may be used as a starting motor. Synchronous motors which form one unit of a motor-generator set, where the other unit is a direct-current generator, are very often started by using the direct-current generator as a motor.

A polyphase synchronous motor may be started as an induction motor by making use of its amortisseur or damper winding. The eddy-current and hysteresis losses in the pole faces produced by the revolving field set up by the armature reaction of a polyphase motor will produce a starting torque which may cause the motor to start even without the amortisseur winding. The starting torque produced without the amortisseur would be small and might not be sufficient alone to start the motor. Moreover, the current required would be excessive. Single-phase motors have no revolving field due to their armature reaction. Consequently, they cannot be started by means of an amortisseur winding. Single-phase motors are of little practical importance and are seldom used and then only in very small sizes.

If a synchronous motor is to be brought up to speed as an induction motor, care must be taken to design it in such a way that the reluctance of the air gap under the poles is constant for any position of the poles with respect to the armature. If the reluctance of the air gap under the poles varies with their position, the motor will tend to lock in the position of minimum

reluctance when the stator is excited, and a large torque will be required to move it from this locked position.

The question of whether the reluctance of the air gap over the poles varies with the position of the rotor, depends upon the spacing of the armature slots. Fig. 169 shows a spacing for which the air-gap reluctance is not constant. The left-hand of the figure shows a field pole in the position which makes the reluctance a maximum. The position for minimum reluctance is shown in the right-hand half of the figure.

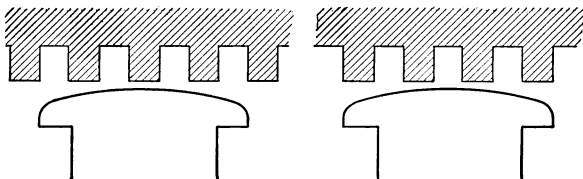

FIG. 169.

The armature reaction of a polyphase synchronous motor operating at synchronous speed is constant and fixed in space phase with respect to the poles and produces no effect on the damping winding, except when there is hunting. When the rotor is at rest or revolving at any speed below synchronism, there is relative motion between the field produced by the armature reaction and the poles, which causes currents to be induced in the damper. These currents produce the same effect as the currents induced in the squirrel-cage winding of an induction motor and will cause the motor to speed up.

A synchronous motor can never reach synchronous speed under the action of the currents induced in its damper alone, but, if the damping winding is properly designed, the motor may reach a speed which is near enough to synchronous speed to pull into step before the field is excited, provided the motor has salient poles as all synchronous motors do. The lagging component of the starting current will usually produce sufficient field excitation to cause the motor to pull into step.

When the motor has reached synchronous speed, the excitation is entirely due to the armature reaction. If now when the field is closed it happens to oppose the polarity produced by armature reaction, the motor will slip 180 degrees and will only

be pulled into step at the expense of a large rush of current. To avoid this current rush, it is best to excite the field through a large resistance just before synchronous speed is reached. This will cause the motor to pull into step with the correct polarity.

The starting torque of an induction motor depends upon the resistance and the reactance of its short-circuited rotor winding. For maximum starting torque, the resistance should be equal to the reactance measured at the impressed frequency. The difference between the actual speed of an induction motor and its synchronous speed, *i.e.*, its slip, is directly proportional to the resistance of its rotor winding. If it were possible to make the resistance of the rotor winding zero, an induction motor would operate at synchronous speed at all loads. The requirements for small slip and large starting torque are opposite so far as the resistance of the rotor is concerned. Since a synchronous motor starts as an induction motor, to pull into step easily, it should have a damping winding of very low resistance, but in order to start readily, especially under load, the resistance of its damper should be high. For maximum starting effort the resistance should be equal to the reactance. The conditions for good starting torque are incompatible with pulling into step readily and a compromise is, therefore, necessary.

The frequency of the current in the damper is very low when synchronous speed has nearly been reached and the local core loss produced by the current in the winding and also the skin effect become very small. The ohmic and effective resistances under this condition are very nearly equal. At the instant of starting, however, the current in the damper is of the same frequency as the voltage impressed on the motor. The local losses produced by this current as well as the skin effect may make the apparent resistance of the damper considerably greater than its ohmic resistance. By making use of this difference between the ohmic and effective resistances, it is possible to design a damper which will start a synchronous motor under load. The chief objections to starting a synchronous motor by the use of a damping winding are the large current required and the high voltage induced in the field winding. The large current, which is a lagging current, may seriously disturb the voltage regulation of the system.

The high voltage induced in the field winding during starting is caused by the armature reaction flux sweeping across the pole faces. This voltage is a maximum at the instant of starting and zero when synchronous speed is reached. To keep this voltage as low as possible, the voltage for the field excitation of a self-starting synchronous motor should be low in order to permit a small number of field turns. A switch may be provided to sectionalize the field winding during starting though this is seldom done on account of constructional difficulties. The voltage strain on the field insulation is then limited to that generated in a single section instead of that generated in the entire field winding. Extra insulation must always be provided on the fields of self-starting synchronous motors. The presence of the damping winding considerably reduces the voltage which would otherwise be induced in the field winding by the reaction of the currents induced in it. Short-circuiting the field winding will also reduce the voltage induced in it during starting and at the same time slightly increase the starting torque. The increase in the starting torque produced in this way is small on account of the high reactance of the field winding.

When synchronous motors are started as induction motors, the voltage impressed on them should be reduced in starting and while they are coming up to speed. This reduced voltage may be obtained by using a starting compensator or from taps on the secondary windings of the transformers supplying the motors, in case transformers are used. Transformers are seldom used with synchronous motors unless the voltage of the line from which they are operated exceeds 13,500. Above that voltage, it is more economical to use transformers than to insulate a motor for full line voltage.

To bring a synchronous motor, which has a damping winding, up to speed, its field is opened or in some cases short-circuited. About one-half normal voltage is then applied to its terminals. It should start slowly and if the damper has been properly designed it should speed up with increasing acceleration. The time required to come up to speed will depend upon the fraction of full voltage applied, the size of the motor, and its design. It should not exceed a minute or a minute and a half, for moderate sized motors. When nearly the maximum speed has been at-

tained—this can be told by the sound—the field circuit should be closed through a moderate amount of resistance and full voltage applied to the motor. The field should then be adjusted to make the motor operate at the desired power factor. Slight over-excitation is more desirable than under-excitation since it will make the motor take a leading current and in a measure compensate for the reactive components of the currents taken by other loads on the line. Moreover, a slightly over-excited synchronous motor is more stable than one which is under-excited. If the motor is to operate with fixed excitation, the field should be adjusted initially to make the motor operate at approximately unit power factor at its average load unless the conditions under which it is to operate make some other power factor more desirable.

When a synchronous motor is to be started by the induction-motor action of its damping coils or by the torque produced by hysteresis and eddy-current losses in the pole faces, a short air gap is desirable in order to keep the starting current small. A short air gap will give rise to a soft coupling which may be undesirable. The selection of the best length of air gap for any motor is a compromise and depends upon the particular service demanded.

CHAPTER XXVII

CIRCLE DIAGRAM OF THE SYNCHRONOUS MOTOR; PROOF OF THE DIAGRAM; CONSTRUCTION OF THE DIAGRAM; LIMITING OPERATING CONDITIONS; SOME USES OF THE CIRCLE DIAGRAM

Circle Diagram of the Synchronous Motor.—Circle diagrams were first applied to synchronous machines by André Blondel.¹ Although such diagrams assist in determining the general operating characteristics of a motor, they cannot be used for predetermining these characteristics with accuracy, since all circle diagrams are based upon the assumption of constant resistance and constant synchronous reactance. Blondel's original circle diagram of the synchronous motor and generator was a diagram of voltages. The circle diagram of currents, which is in reality merely a modification of the voltage diagram, is, in some respects, more convenient for the motor than the diagram of voltages and alone will be given.

Proof of the Diagram.—Let Fig. 170 be the vector diagram of a synchronous motor on which V , without the minus sign, will be used to represent the drop in voltage through the motor. This diagram is similar to the one given in Fig. 166, page 315 rotated through 90 degrees. Let P , P_m and $E_o = I_a z_s$ represent respectively, the power input, the internal power developed, and the resultant voltage forcing the current through the circuit. Everything on the diagram, as on all previous diagrams, is per phase. Take V as a fixed reference line. This will be drawn vertically for convenience.

$$I_a = \frac{E_o}{z_s}$$

and according to the assumptions made in regard to x_s and r_c ,

$$\tan \Delta = \frac{x_s}{r_c}$$

is constant.

¹ Moteurs Synchrones à Courants Alternatifs, by André Blondel, also L'Industrie Électrique, February, 1895.

If the motor excitation remains constant, $ab = E_a'$ will be constant and the extremity of the vector E_o will swing on the arc of a circle, bce , as the current varies. Since the current is proportional to and makes a constant angle with E_o , the extremity of the current vector OI_a will also swing on the arc of a circle HI_a .

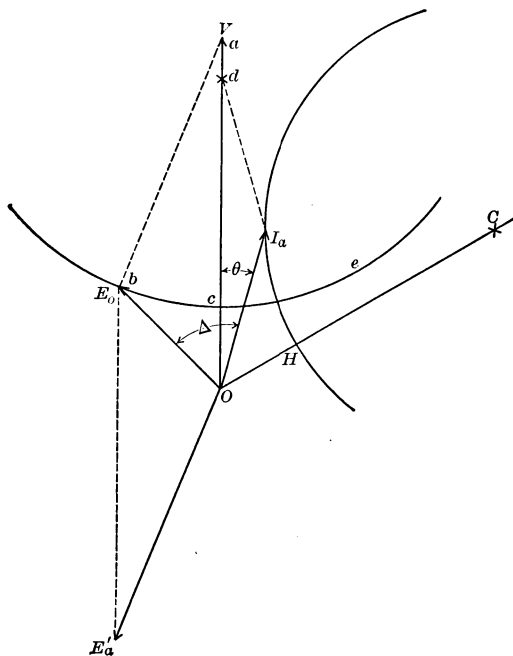

FIG. 170.

If the motor excitation is decreased, E_a' will decrease and the point E_o will approach the point V . It will coincide with V , which is the center of the voltage circle bce , when the excitation is zero. At the same time I_a will approach the center of its circle, and will coincide with this center when E_o coincides with V . When E_o and V coincide, OI_a will lie along the diameter of the circle HI_a . OC will therefore make an angle $\tan^{-1} \frac{x_s}{r_e}$ with OV and will be equal to the voltage, OV , impressed on the motor divided by the synchronous impedance.

$$OC = \frac{OV}{z_c} \quad (106)$$

C will be the center of a system of concentric circles corresponding to different motor excitations. These circles are the motor excitation circles of the circle diagram.

If the excitation is constant, I_a will travel along the arc of the circle HI_a and when E_o coincides with c , I_a will coincide with H , and will be equal to

$$OH = \frac{Oc}{z_s} = \frac{E_o}{z_s}$$

$$HC = OC - OH = \frac{OV}{z_s} - \frac{E_o}{z_s} = \frac{E_a'}{z_s}$$

That is, the radius of any motor excitation circle is equal to the corresponding excitation voltage divided by the synchronous impedance.

Take any point, such as d , on the line OV which represents the impressed voltage.

$$(dI_a)^2 = (Od)^2 + (OI_a)^2 - 2(Od)(OI_a) \cos \theta$$

and

$$(Od)^2 - (dI_a)^2 = 2(Od)(OI_a) \cos \theta - (OI_a)^2$$

If Od is made equal to

$$\frac{OV}{2r_e} = \frac{\text{impressed voltage}}{\text{twice the effective resistance}}$$

$$(Od)^2 - (dI_a)^2 = \frac{P}{r_e} - I_a^2$$

and

$$(Od)^2 - (dI_a)^2 = \frac{P_m}{r_e} \quad (107)$$

where P and P_m are, respectively, the input and the internal output of the motor.

If the motor power, P_m , is fixed, equation (107) is the equation of a circle having a radius equal to dI_a and a center at a distance, $Od = \frac{V}{2r_e}$, above the point O . Hence, for any fixed motor power the extremity of the current vector OI_a must be on a circle drawn about the point d as a center. The point d will be the center of a system of power circles corresponding to different motor powers.

Substituting $Od = \frac{V}{2r_e}$ in equation (107) gives

$$\left(\frac{V}{2r_e}\right)^2 - (dI_a)^2 = \frac{P_m}{r_e}$$

$$dI_a = \left\{ \left(\frac{V}{2r_e}\right)^2 - \frac{P_m}{r_e} \right\}^{1/2} \tag{108}$$

Equation (108) gives the radius of any power circle in terms of the motor power, P_m , the impressed voltage, V , and the resistance of the motor, r_e .

Od and Cd are equal. This can be proved by showing that the apex of the isosceles triangle, having OC for a base and OV for the direction of one side, coincides with the point d .

From the construction of Fig. 170, the angle COV is equal to the angle Δ . The length of the side of the isosceles triangle is, therefore,

$$\frac{OC}{2} \frac{1}{\cos \Delta} = \frac{OC}{2} \frac{z_s}{r_e}$$

From equation (106) $OC = \frac{OV}{z_s}$

Substituting this in the preceding equation gives for the length of the side of the triangle $\frac{OV}{2r_e}$

This is equal to the distance Od on the diagram.

The radius of the circle of zero power may be found by putting $P_m = 0$ in equation (108). Making this substitution gives $dI_a = \frac{V}{2r_e}$ as the radius of the circle of zero power. Since dO is equal to $\frac{V}{2r_e}$ and dO and dC are equal, this circle passes through the two points O and C . The circle of zero power, therefore, passes through the center, C , of the system of excitation circles.

Construction of the Diagram.—Choose a suitable current scale. This scale will be used for all lines on the diagram. Everything will be per phase. Refer to Fig. 171. Lay off the line OC making an angle $\tan^{-1} \frac{x_s}{r_e}$ with the line Od .

Power Circles.—The circle, OCD , of zero power is fixed by the points O and C , and the direction of its diameter, Od . A more

accurate method of determining this circle is to find the position of its center, d .

$$Od = \frac{V}{2r_e}$$

The diameter of the circle of maximum power is zero. The radii of other power circles are found from equation (108) which gives for the radius of any power circle

$$\left\{ \left(\frac{V}{2r_e} \right)^2 - \left(\frac{P_m}{r_e} \right) \right\}^{1/2} = \frac{1}{2r_e} \left\{ V^2 - 4r_e P_m \right\}^{1/2}$$

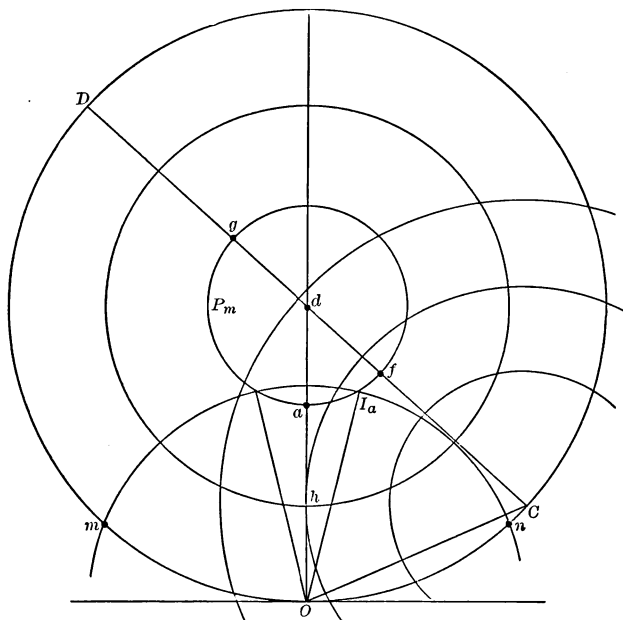

FIG. 171.

It is usually convenient to have the power circles represent definite electromagnetic outputs, as for example, 100, 200, 300, 400, etc., kilowatts. Three power circles are shown on Fig. 171.

Excitation Circles.—A series of concentric circles representing different motor excitation voltages may be drawn with C as a center. It is sometimes convenient to draw these circles to represent different per cents. of the excitation voltage which

makes E_a' equal to V . One hundred per cent. excitation is represented on the diagram by OC , which is equal to $\frac{V}{z_s}$. Three excitation circles are shown on the figure. A line drawn from C to I_a represents the motor excitation, corresponding to the current I_a and the power P_m , both in magnitude and in phase, and the angle I_aCO this line makes with the line OC is the phase angle between E_a' and $-V$ on Fig. 170.

Current Circles.—A series of current circles may also be drawn with O as a center. Only one of these, $mI_a n$, is shown. For any fixed electromagnetic motor power, such as is represented by the power circle marked P_m , there can be two motor excitations corresponding to the current I_a . The two corresponding excitation circles are fixed by the intersection of the current circle, $mI_a n$, with the power circle P_m .

Limiting Operating Conditions.—*Maximum and Minimum Excitation for Fixed Motor Power.*—The maximum and minimum excitations at which the motor can develop the power P_m , are respectively, Cg and Cf . The excitation circles corresponding to these are not shown. The points g and f are points of tangency between the motor power circle and the two excitation circles. The currents corresponding to these excitations are Og and Of . The former leads, the later lags.

Minimum Power Factor.—The power factor for any condition is equal to the cosine of the angle made by the current line with the line Od . All currents to the right of Od are lagging. All those to the left of Od are leading. The minimum power factor for any load occurs when the current line is tangent to the power circle for the given load. If the point of tangency for lagging current lies above the line CD , it represents an unstable condition. In this case the minimum power factor for lagging current for stable operation will occur when the extremity of the current line lies on CD .

The Maximum Possible Motor Excitation.—The maximum possible motor excitation is CD , where D is the point of tangency of the circle of zero power with a motor excitation circle. CD is the diameter of the circle of zero power. This diameter is equal to $\frac{V}{r_e}$ laid off to the scale of currents. The maximum excitation in volts is $(CD)z_s$.

The Maximum Possible Motor Power.—The diameter of the circle of maximum motor power is zero. The radius of any power circle according to equation (108) is

$$\frac{1}{2r_e} \sqrt{V^2 - 4r_e P_m}$$

If this equation is to be equal to zero, V^2 must be equal to $4r_e P_m$, and

$$P_m = \frac{V^2}{4r_e}$$

The excitation corresponding to this is $Cd = \frac{V}{2r_e}$ which is equal to one-half of the maximum possible excitation.

Stability.—All currents lying above the line CD represent unstable conditions of operation. Any increase in load on a motor will cause it to start to slow down, that is, to cause the lag of the motor voltage to increase. If the excitation is fixed, this increase in lag will produce an increase in the current (Fig. 171). With fixed excitation, any increase in the current beyond the line CD (Fig. 171) will cause the extremity of the current line to move to a power circle of larger radius and consequently of smaller power.

Some Uses of the Circle Diagram.—Besides being of use for determining the approximate operating characteristics of a synchronous motor, the circle diagram is very convenient in helping to explain simply certain peculiarities in the characteristics of such a motor. For example: the possible range of under-excitation with fixed motor power is much less than the range of over-excitation for the same power. Referring to Fig. 171, let the constant motor power be P_m . The range of under-excitation is confined to excitation circles which cut the power circle, P_m , between a and f , but the range of possible over-excitation includes excitation circles which cut the power circle between a and g . This shows why V -curves always extend further on the side corresponding to over-excitation than on the other side.

The complete V -curve of a synchronous motor calculated from the circle diagram is plotted in Fig. 172. The dotted part of this curve corresponds to the part of the circle diagram beyond CD and represents unstable conditions.

That the compounding curve for unity power factor should at first bend toward lower excitations as the output is increased can easily be seen from the circle diagram.

Why the compounding curve for unity power factor should bend in this way was explained in Chap. XXIV. The middle power circle on Fig. 171 corresponds to the power for which the excitation is a minimum for unity power factor. For this power, the excitation circle for unity power factor is tangent to the line

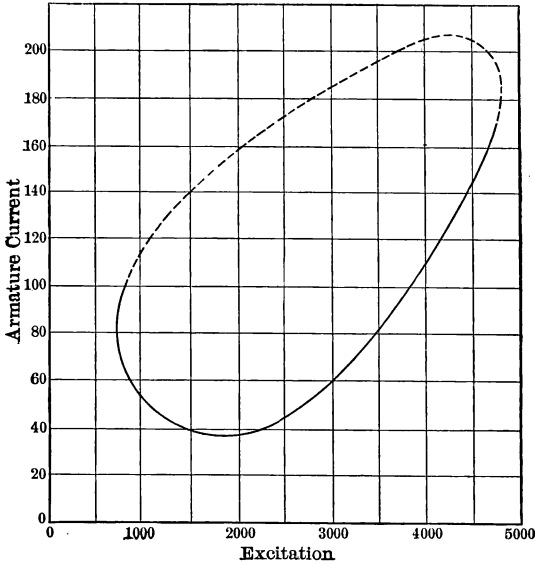

FIG. 172.

Od. For powers either greater or less than this, the excitation for unity power factor is greater. The power for which the excitation is a minimum depends upon the angle COd . This is $\tan^{-1} \frac{x_s}{r_e}$. For most motors the ratio of $\frac{x_s}{r_e}$ is so large that the output at which the bend in the compounding curve for unity power factor occurs is not much above, or even may be less than, the electromagnetic output on the diagram which corresponds to no load on the motor.

CHAPTER XXVIII

LOSSES AND EFFICIENCY; ADVANTAGES AND DISADVANTAGES; USES

Losses and Efficiency.—A synchronous motor does not differ essentially from a synchronous alternator. Consequently, the losses in the two machines are identical and they may be determined in exactly the same manner. The same methods may be employed for calculating the efficiency of a synchronous motor and a synchronous generator. The losses and the method of calculating the efficiency of a generator are discussed in Chapter VII, page 123, under "Synchronous Generators."

Advantages and Disadvantages.—The chief advantage of the synchronous motor is its ability to operate at different power factors and the ease with which its power factor may be adjusted. Its comparative simplicity and the possibility of winding it economically for high voltages, thus doing away with the necessity for transformers, are advantages, but these are also possessed by the induction motor. Its invariable speed under varying load is also an advantage under certain conditions. Its main disadvantages are its tendency to hunt and its lack of any inherent starting torque. In the case of polyphase motors, neither of these objections are serious and they are of little consequence when a motor is provided with a properly designed damper and operates under reasonably good conditions. The lack of good starting torque limits the use of synchronous motors to places where frequent starting is unnecessary. They are seldom built in small sizes, that is under 100 or 200 kw.

Synchronous motors are less sensitive to variations in the voltage impressed upon them than induction motors. This is an advantage in some cases as it enables them to carry their loads without getting out of synchronism during periods of reduced voltage caused by some temporary trouble on the line or in the power house. A synchronous motor which has the same breakdown torque as an induction motor will continue

to carry its full load at a voltage which is considerably lower than that which would cause the induction motor to break down. The maximum output of an induction motor varies as the square of the impressed voltage, while the maximum output of a synchronous motor having usual constants operating with constant excitation varies nearly as the first power of the impressed voltage (equation 98). If a synchronous motor and an induction motor each having a maximum output equal to twice their rated outputs were put on half voltage, the synchronous motor could still develop its full load without getting out of synchronism. The induction motor, however, would break down at one-half its rated output.

Uses.—The principal uses of synchronous motors are in connection with motor generators, including frequency changers, and as synchronous condensers. They are not very satisfactory for ordinary power work mainly on account of their lack of good starting characteristics. The chief reason for their use in connection with motor-generator sets is the possibility of varying their power factor to control the wattless current taken from the supply system. By operating the synchronous motors slightly over-excited, the reactive current taken by transformers or by inductive loads connected to the system can be in part or wholly neutralized. If the distributing system of a power plant supplying a part of its power through synchronous motor-generators is properly laid out, unity power factor may be maintained at the station. The constant-speed feature of synchronous motors makes them particularly adapted for use in frequency changers.

Synchronous motors are frequently used without load in connection with transmission systems to control the power factor and to better the voltage regulation. When used in this way, they are called synchronous condensers. Although synchronous motors, if over-excited, take a leading current like a condenser, they do not behave like a condenser in other respects. The wattless current taken by a condenser is directly proportional to the voltage. The wattless current taken by an over-excited synchronous motor operating with fixed excitation decreases with an increase in voltage and becomes zero at a certain voltage. A further increase in the impressed voltage will cause the wattless

component of the current to reverse and become a lagging component.

If a synchronous motor is to be used as a synchronous condenser to control the voltage of a line, the line must contain reactance. This reactance may be the natural reactance of the line if the line is of sufficient length or it may be inserted artificially. The entire control of the voltage is due to the voltage drop in the reactance. The motor merely serves as a means of making the current through the reactance lead or lag. A leading current through a reactance will cause a rise in voltage. A lagging current will produce the opposite effect.

A synchronous motor operating with constant excitation tends to automatically maintain constant voltage across its terminals provided there is reactance in the power mains supplying it. For example, suppose a synchronous motor were operating with normal excitation, *i.e.*, the excitation which produces unit power factor, and the line voltage drops. The excitation of the motor will now be higher than normal for the reduced impressed voltage, and the motor will take a leading current. This leading current will cause a rise in voltage through the line reactance which will tend to restore the voltage at the motor. If the voltage at the motor rises, the motor will take a lagging current which will produce a drop in voltage in the reactance of the line which will tend to offset the change in voltage. The tendency of a synchronous motor to maintain constant voltage at its terminals does not depend upon its initial excitation. Normal excitation was chosen merely to simplify the explanation.

A polyphase synchronous motor floated on a circuit carrying an unbalanced load tends to restore balanced conditions both in regard to current and voltage. If the system is badly out of balance, the synchronous motor may take power from the phases with high voltage and deliver power to the phase or phases with low voltage.

PARALLEL OPERATION OF ALTERNATORS

CHAPTER XXIX

GENERAL STATEMENTS; BATTERIES AND DIRECT-CURRENT GENERATORS IN PARALLEL; ALTERNATORS IN PARALLEL; SYNCHRONIZING ACTION; TWO EQUAL ALTERNATORS; SYNCHRONIZING CURRENT; INDUCTANCE IS NECESSARY FOR PARALLEL OPERATION; CONSTANTS OF GENERATORS FOR PARALLEL OPERATION NEED NOT BE INVERSELY PROPORTIONAL TO THEIR RATINGS

General Statements.—Since the terminals of all generators operating in parallel are connected to common busbars, the terminal voltages of all generators so operating must be equal if measured at the point at which they are paralleled. The load carried by the individual generator and the phase relation between its armature current and generated voltage must adjust themselves to maintain equal terminal potentials. If the impedance in the cables between the generators and the busbars or the point at which the generators are put in parallel is zero, the actual potentials at the generator terminals will be equal. In all that follows, unless otherwise stated, the words terminal voltage when applied to a generator will mean the voltage of the generator measured at the point of paralleling and the constants of the generators will include the constants of the line or leads up to this point. The terminal voltage at the point of paralleling will be equal to the actual terminal voltage of the generator minus the drop in the cables between it and the point of paralleling.

In the case of alternators, not only must the terminal voltages as measured by a voltmeter be equal, but they must be equal at every instant. In other words, alternators operating in parallel must be in synchronism and their terminal voltages must also be in phase with respect to the load and must so remain. Fortunately, the natural reactions which result from a departure from synchronism are such as to re-establish it.

Unless mechanically coupled, alternators cannot ordinarily be operated in series, their natural stable condition being in parallel. If one of two alternators in parallel leads its proper phase with respect to the other, more load is automatically thrown upon it. At the same time the other generator, lagging its proper phase, is relieved of some of its load. The result is that the generator which is leading slows down and the generator lagging speeds up until the proper phase relation is restored. This shift of load between two or more generators which are in parallel is equivalent to a transfer of energy from one to the other. Although it is sometimes convenient to consider the shift of load as an interchange of energy, in reality no actual transfer of energy takes place except when the load on the system is zero or when the load on a generator is less than the change in its load required to restore synchronism.

Batteries and Direct-current Generators in Parallel.—Consider first a battery consisting of a number of cells connected in parallel. Let E , I and R with subscripts 1, 2, 3, etc., indicate, respectively, the internal voltage, the current and the resistance of the cells. Let V be their common terminal voltage. The currents delivered by the individual cells must be such as to make all terminal voltages equal.

$$V = E_1 - I_1 R_1$$

$$V = E_2 - I_2 R_2$$

$$\text{etc.} \quad \text{etc.}$$

and

$$I_1 = \frac{E_1 - V}{R_1}$$

$$I_2 = \frac{E_2 - V}{R_2}$$

$$\text{etc.} \quad \text{etc.}$$

The total current supplied by the batteries in parallel is

$$I_o = I_1 + I_2 + \text{etc.} = \Sigma \frac{E - V}{R}$$

$$= \Sigma \frac{E}{R} - V \Sigma \frac{1}{R}$$

$$\Sigma \frac{E}{R} - I_o$$

$$V = \frac{\Sigma \frac{E}{R} - I_o}{\Sigma \frac{1}{R}}$$

Substituting this value of V in the expression for the current in cell No. 1 gives

$$I_1 = \frac{E_1}{R_1} - \frac{\Sigma \frac{E}{R}}{R_1 \Sigma \frac{1}{R}} + \frac{I_o}{R_1} \frac{1}{\Sigma \frac{1}{R}}$$

If the internal voltages of the cells are all equal

$$I_1 = \frac{I_o}{R_1} \frac{1}{\Sigma \frac{1}{R}}$$

Therefore, if all the internal voltages are equal, the total current carried by the system will be divided among the cells in inverse proportion to their internal resistances, and no current will flow in the cells when the external load is zero. If the resistances are all equal, the currents in the cells will also be equal. If the internal voltages are not all equal, the currents carried by the cells will not be inversely proportional to their resistances and a current will flow in some of the cells when the external load is zero. The cells with low voltage may have current flow through them against their internal voltages, and at some loads certain of the cells may deliver no current. This latter condition will occur whenever the internal voltage of a cell is equal to the common terminal voltage of the system. When it is greater than the common terminal voltage, the cell will deliver current and when it is less the cell will take current from the system. This last condition corresponds to motor action. The former corresponds to generator action. The preceding statements apply equally well to direct-current generators provided R is used as the total resistance of the armature circuit. This includes the resistance of a series field when the generators are compounded. In the case of compound generators, the equalizer is assumed to carry no current.

Alternators in Parallel.—The method which has just been applied to batteries in parallel for determining the currents delivered by the individual cells, may be applied to alternators, but when so applied all currents and voltages must be taken in a vector sense and the resistances must be replaced by impedances.

Consider a number of alternators which are in parallel. Let E , V and z be, respectively, the generated voltage, the terminal voltage, and the impedance of the alternators. E will be either the voltage corresponding to excitation or to the resultant field according as z is the synchronous impedance or the armature-leakage impedance. Subscripts will be used to distinguish the different alternators when such distinction is necessary. It must be remembered that all of the expressions which follow are to be taken in a vector sense and that sine waves are assumed. The effect of harmonics will be considered later.

The current delivered by any alternator is

$$I = \frac{E - V}{z} \quad (109)$$

and the total current I_o taken by the load is

$$\begin{aligned} I_o &= \Sigma \frac{E - V}{z} \\ &= \Sigma \frac{E}{z} - \Sigma \frac{V}{z} \end{aligned}$$

But since all the terminal voltages, V , are equal and in phase,

$$\begin{aligned} I_o &= \Sigma \frac{E}{z} - V \Sigma \frac{1}{z} \\ &= \Sigma \frac{E}{z} - V Y_o \end{aligned}$$

where Y_o is the resultant admittance of the armatures in parallel. Therefore,

$$V = \frac{\Sigma \frac{E}{z} - I_o}{Y_o} \quad (110)$$

Hence,

$$\begin{aligned} I_1 &= \frac{E_1}{z_1} - \frac{\Sigma \frac{E}{z}}{Y_o z_1} + \frac{I_o}{Y_o z_1} \\ I_1 &= y_1 E_1 - \frac{y_1}{Y_o} \Sigma (E y) + I_o \frac{y_1}{Y_o} \end{aligned} \quad (111)$$

where y_1 is the admittance corresponding to z_1 .

If the voltages, E , are all equal and in phase, then

$$\frac{y_1}{Y_0} \Sigma(Ey) = y_1 E_1$$

and

$$I_1 = I_0 \frac{y_1}{Y_0} \quad (112)$$

Hence when all generated voltages are equal and in phase, the currents carried by the individual alternators are directly proportional to their admittances or inversely proportional to their impedances. The vector sum, but not the algebraic sum, of these currents is equal to the total current delivered by the system. If, under this condition $\frac{r_1}{x_1} = \frac{r_2}{x_2}$, etc., Y_0 will be equal to the algebraic sum of y_1, y_2, y_3 , etc., and the total current delivered by the system will be divided among the generators in direct proportion to their admittances. All of the individual armature currents will be in phase with the load current and their algebraic sum will be equal to the total current delivered by the system. The condition of the generated voltages being equal and in phase corresponds to the condition existing when transformers with equal ratios of transformation and negligible exciting currents are paralleled. If the constants are not in the relation indicated above, it is still possible to have the component currents in phase and inversely proportional to their impedances or in any other proportion but in this case E_1 and E_2 will neither be equal nor in phase.

Since the vector sum of the first two terms of equation (111) is the component current carried by the armature of an alternator due to its voltage being out of phase or not equal to the generated voltages of the other alternators, the first two terms of equation (111) may be considered to be a current interchange or a circulatory current between one alternator and the others. This circulatory current never gets to the load. It may or may not be wattless with respect to the terminal voltage, depending upon the conditions which cause it. This interchange current is not a separate current. It is merely one of the components into which the armature current may be resolved under certain conditions. Its presence may or may not be desirable.

Two Equal Alternators.—Consider two equal alternators, *i.e.*, alternators with equal constants and the same rating. For two alternators equation (111) reduces to

$$I_1 = y_1 E_1 - \frac{y_1}{Y_o} (E_1 y_1 + E_2 y_2) + I_o \frac{y_1}{Y_o} \tag{113}$$

If

$$y_1 = y_2 \text{ and } \frac{r_1}{x_1} = \frac{r_2}{x_2}$$

$$I_1 = y_1 E_1 - \frac{y_1}{Y_o} y_1 (E_1 + E_2) + I_o \frac{y_1}{Y_o}$$

$$\begin{aligned} I_1 &= y_1 E_1 - \frac{y_1}{2} (E_1 + E_2) + \frac{I_o}{2} \\ &= y_1 \left(\frac{E_1 - E_2}{2} \right) + \frac{I_o}{2} \end{aligned} \tag{114}$$

The current carried by each alternator under these conditions is equal, vectorially, to one-half the load current plus a component current $I_i = y_1 \left(\frac{E_1 - E_2}{2} \right)$ which circulates between the two armatures. The conception of a circulatory current is apt to mislead except with two identical alternators.

Synchronizing Action, Two Equal Alternators.—The circulatory current is equal to $y_1 \frac{E_1 - E_2}{2}$ (equation 114). This current may

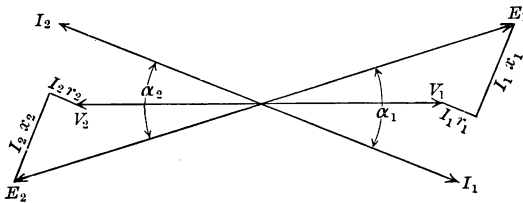

FIG. 173.

be caused by one of two things: by E_1 and E_2 being out of phase; by E_1 and E_2 differing in magnitude. The effect of the circulatory current will be different in the two cases. When it is produced by a difference in phase, it produces synchronizing action. When resulting from an inequality in the voltages, it merely equalizes the terminal voltages, mainly by its effect on armature reaction. If two equal alternators which have equal

excitations and carry equal loads are in parallel, there will be no interchange current between them unless they are displaced in phase from exact synchronism. If they become so displaced, an apparent interchange of energy will take place between them which will tend to restore synchronism. The natural tendency of two alternators, which are in parallel, to remain in synchronism, will be made clear by the vector diagrams shown in Figs. 173 and 174. These diagrams are for equal alternators with equal excitations and equal loads. Both diagrams are drawn with respect to the series circuit consisting of the two armatures. The terminal voltages which are equal and in phase when considered with respect to the parallel circuit are opposite in phase when considered with respect to their own series circuit. Equa-

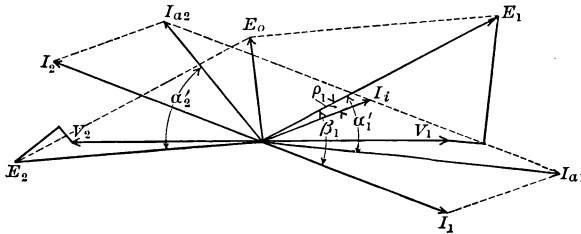

FIG. 174.

tion (114) applies to the parallel circuit. To make it apply to the series circuit, the sign of E_2 must be changed.

Fig. 173 represents the condition before either generator has become displaced. Fig. 174 represents the condition when the generators are slightly out of phase. V , E and I are, respectively, the terminal voltage, the excitation voltage and the load component of the armature current. The subscripts 1 and 2 refer to generators 1 and 2, respectively.

Since Fig. 173 represents the condition of synchronism and equal excitations, E_1 and E_2 are equal and opposite and their resultant is zero. The total load current delivered by the system is I_1 minus I_2 when referred to the voltage V_1 . When referred to the voltage V_2 , it is I_2 minus I_1 . In Fig. 174, E_1 and E_2 are still equal but they are not exactly in opposition since the generators are assumed to be slightly out of phase.

Since E_1 and E_2 are not in opposition, their resultant $E_o = E_1 + E_2$ (Fig. 174) is not zero.

The resultant voltage E_o acts through the impedances of the two armatures and produces a component current

$$I_i = \frac{E_o}{2z}$$

in the series circuit consisting of the two armatures. The synchronous impedance of each armature is $z = r + jx$. This component current or circulatory current, as it is called, lags behind E_o by an angle $\tan^{-1} \frac{x}{r}$. Since the ratio of the synchronous reactance to the effective resistance of a synchronous generator is usually large, this angle is also generally large, equal to at least 85 degrees.

The current, I_i , has a component which is in phase with E_1 and a component which is in opposition to E_2 . It, therefore, produces generator power with respect to machine No. 1 and motor power with respect to machine No. 2. The power output of an engine or turbine depends upon its mean speed. Since the mean speed of the alternators does not change when they are displaced in phase, the power they receive from their prime movers is not altered by a change in phase. The effect of the interchange of current due to the phase displacement is, therefore, to slow machine No. 1 which leads and accelerate machine No. 2 which lags. In other words, the circulatory current tends to bring the rotors of the generators into synchronism, *i.e.*, into the phase position which puts E_1 and E_2 in opposition as shown in Fig. 173.

As a result of the circulatory current, I_i , there is an apparent transfer of energy from one generator to the other. This apparent transfer of energy between two generators which are in parallel is the synchronizing action which makes the parallel operation of alternators possible.

The current carried by the armature of either alternator is the vector sum of the circulatory current and the component of the load current the alternator would carry if there were no circulatory current. Referring to Fig. 174, generator No. 1 has an armature current, I_{a_1} , which is equal to the vector sum of I_1

and I_i . The armature current of generator No. 2 is the resultant of I_2 and I_i . This is I_{a_2} . The only actual currents are armature currents I_{a_1} and I_{a_2} . I_1 , I_2 and I_i exist merely as components. The current delivered by the system is still the difference between I_1 and I_2 . This is equal to the vector difference between the armature currents I_{a_1} and I_{a_2} .

Synchronizing Current.—The change in the electrical output of the generators when they are displaced in phase is in part due to the power developed by the interchange current, I_i , considered with respect to the generated voltages E_1 and E_2 , and in part due to the change caused by I_i in the phase and magnitude of the generated voltages with respect to the currents I_1 and I_2 . Referring to Figs. 173 and 174, the change in the power developed by generator No. 1 due to a phase displacement such as is indicated in Fig. 174 is

$$E_1 I_{a_1} \cos \alpha'_1 - E_1 I_1 \cos \alpha_1$$

Assuming that the terminal voltage, V , does not change, I_1 will not change and

$$\begin{aligned} E_1 I_{a_1} \cos \alpha'_1 - E_1 I_1 \cos \alpha_1 \\ = E_1 I_1 (\cos \beta_1 - \cos \alpha_1) + E_1 I_i \cos \rho_1 \end{aligned}$$

The greater part of the synchronizing power is caused by I_i directly and, for this reason, I_i is sometimes called the *synchronizing current*.

Inductance is Necessary for Parallel Operation.—Considering the part of the synchronizing action which is due to I_i —the only part which can exist when there is no load on the system—it will be seen by referring to Fig. 174, that this part can be present only when I_i lags behind E_o . If E_1 and E_2 are equal, as was assumed, and I_i is in phase with E_o , it would have equal positive projections on E_1 and E_2 and would produce an equal generator effect on each alternator. Under this condition, it would have no tendency to restore synchronism. Under certain special conditions, there still may be a slight synchronizing action due to the change in the phases of E_1 and E_2 with respect to I_1 and I_2 , respectively, but this action does not always exist, can never exist at no load and is always too small alone to make the parallel operation of alternators possible. The synchronizing

action of I_i is dependent upon its lag behind E_o . Inductance is, therefore, absolutely necessary for the parallel operation of alternators. By putting capacity between two alternators which are connected in parallel, the circulatory current, I_i , can be made to lead E_o . Under this condition, the action of I_i is to bring the voltages E_1 and E_2 into conjunction on their series circuit and to bring the generators into conjunction on the series circuit. Although this condition may be produced experimentally, it is of no importance practically. Generators cannot be built without inductance. The natural tendency is, therefore, for all generators which are connected together to assume the proper phase relation for parallel operation. Their stability will depend upon the amount of inductive reactance in their armature circuits and to some extent upon the constants of the load.

The Constants of Generators for Parallel Operation need not be Inversely Proportional to Their Ratings.—When transformers having equal ratios of transformation are operated in parallel, all of their primary voltages must be equal and in phase. All of their secondary voltages must also be equal and in phase. The load they carry and the phase relations between the currents they deliver depend solely upon their constants. For this reason it is important that transformers which are to operate in parallel should have constants approximately inversely proportional to their ratings. The conditions for successful parallel operation of alternators are not nearly so rigid since the excitation voltages, corresponding to the primary voltages in the case of transformers, do not have to be equal or in phase. If the constants of the alternators are not in the inverse ratios of their ratings it makes little difference since the load may still be divided between alternators in any desired way and their armature currents brought into phase. This may be accomplished by properly adjusting the power they receive from their prime movers and also varying their field excitations. If two alternators having dissimilar constants have been made to share the load properly and their armature currents have been brought into phase, there will be a circulatory current according to equation (113), page 346. A circulatory current under these conditions is highly desirable. For this reason, too much emphasis should not be placed on the exist-

ence of a circulatory or interchange current. Such a current is very desirable except when the constants of the alternators operating are exactly inversely proportional to their ratings. It is what makes possible the successful parallel operation of alternators of totally different design.

Modifying equation (111), page 344 so as to make it apply to two alternators, gives for the current in the armature of alternator No. 1

$$I_1 = y_1 E_1 - \frac{y_1}{Y_o} (E_1 y_1 + E_2 y_2) + I_o \frac{y_1}{Y_o} \quad (115)$$

A similar expression applies to alternator No. 2. If the ratio of the loads to be carried by the two alternators is A , then for ideal conditions I_1 should be equal to $I_2 A$ and in phase with it. The value of E_1 in terms of E_2 which will give this condition may be found by equating I_1 and $I_2 A$ and replacing I_1 and I_2 by their values as given by equation 115. This gives

$$E_1 = \frac{E_2 y_2 (Y_o A + y_1 - A y_2) + I_o (A y_2 - y_1)}{y_1 (Y_o + A y_2 - y_1)} \quad (116)$$

Although equation (116) looks somewhat formidable, it shows that for definite constants and any desired ratio, A , between the loads, there is a definite relation between E_1 and E_2 in phase and in magnitude which will not only make the ratio of the loads equal to A but will also bring I_1 and I_2 into phase. In equation (116), E_1 is referred to the same axis as that to which I_o is referred, but beyond showing that a definite relation exists between E_1 and E_2 which will make the alternators divide the load properly, the equation is of no practical value. In order to get E_1 in terms of E_2 from equation (116) the y 's would, of course, have to be replaced by their components, $g - jb$, and I_o would have to be expressed as a vector referred to some axis such as V .

It will be shown that changing the amount of power given by a prime mover to an alternator which operates in parallel with others changes its output and also the phase but not the magnitude of its excitation voltage. Changing the field excitation alters the magnitude of the excitation voltage and also changes its phase but does not appreciably alter the output. Therefore, by adjusting the power given by prime movers to alternators which are in parallel and at the same time adjust-

ing their field excitations the alternators may be made to divide the load properly, provided any reasonable relation exists between their constants.

That it is not necessary, although desirable, for alternators which are to operate in parallel to have constants approximately inversely proportional to their ratings, should be made clear by Fig. 175. Fig. 175 is drawn for two alternators considered with respect to their parallel circuit. I_{a1} and I_{a2} are the two armature currents. These are assumed to have been brought into phase by adjusting the field excitations of the alternators and to have been made proportional to the ratings of the alternators by adjusting the amount of power given to each alternator by its prime mover.

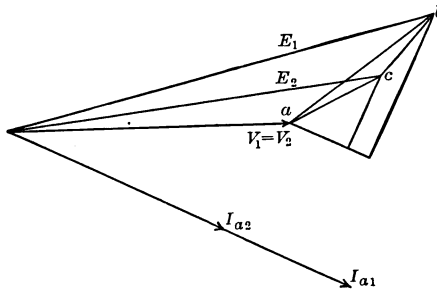

FIG. 175.

Adding the drops due to the currents I_{a1} and I_{a2} to the terminal voltage gives the excitation voltages E_1 and E_2 . Since E_1 and E_2 are not equal, each machine will have a circulatory current according to equation (115). If the excitations are adjusted to give the voltages E_1 and E_2 , the condition represented by the vector diagram shown in Fig. 175 will be fulfilled. With any division of load the armature currents may be brought into phase with the load current by properly adjusting the field excitations. Although there is an unbalanced voltage $E_1 - E_2$ acting in the series circuit consisting of the two armatures, this voltage will not cause any currents in the armatures other than those already existing, since the voltage $E_1 - E_2 = E_{cb}$ is just balanced by the impedance drops which are already present in the armatures. The rise in voltage represented by $E_1 - E_2 = E_{cb}$ is just balanced by the fall of voltage E_{ba} plus the rise E_{ac} .

CHAPTER XXX

SYNCHRONIZING ACTION OF TWO IDENTICAL ALTERNATORS; EFFECT OF PARALLELING TWO ALTERNATORS THROUGH TRANSMISSION LINES OF HIGH IMPEDANCE; THE RELATION BETWEEN r AND x FOR MAXIMUM SYNCHRONIZING ACTION

Synchronizing Action of Two Identical Alternators.—Consider the case of two identical alternators, that is, of two alternators which have equal electrical and mechanical constants. Assume that the governors of the prime movers which drive the alternators are sluggish and do not respond to changes in the

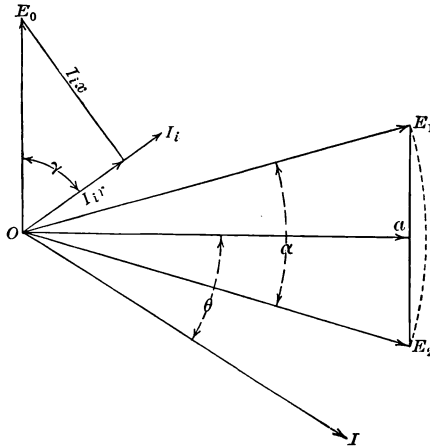

FIG. 176.

angular velocity of the prime movers which are caused by hunting. Under these conditions when hunting occurs, it will not be influenced by any changes in the power developed by either prime mover. When one generator is ahead of its mean phase position the other generator will be behind its mean phase position. In order to simplify the discussion the only case which will be considered is where the alternators have equal excitations and share the load equally when there is no hunting. The excitation voltages will be assumed equal. Fig. 176 is the vector diagram of the alternators drawn with respect to their

parallel circuit and represents the conditions which exist at some instant when their excitation voltages have been displaced in phase from each other by an angle, α .

I is the component of the armature current of each generator which is in phase with the load current. Since the generators are equal, the current I , according to equation (114), is equal to one-half of the current I_o taken by the load. The excitation voltages E_1 and E_2 are assumed equal and constant. When hunting occurs these voltages remain unchanged in magnitude but swing in opposite directions. They are shown in Fig. 176 displaced by an angle α . When there is no hunting they coincide. I_i , the circulatory current for generator No. 1, is equal to $\frac{E_1 - E_2}{2z}$ (equation 114). The circulatory current for generator No. 2 is equal to $\frac{E_2 - E_1}{2z}$ and is opposite to I_i . The latter is not shown on the diagram. Let P_1 and P_2 be the powers developed by generators No. 1 and No. 2, respectively, when they are displaced in phase by an angle α and let I_1 and I_2 be the armature currents under this condition.

$$\begin{aligned}
 P_1 &= I_1 E_1 \cos \theta_{I_1}^{E_1} = \left(\frac{I_o}{2} + \frac{E_1 - E_2}{2z} \right) E_1 \cos \theta_{I_1}^{E_1} \\
 &= (I + I_i) E_1 \cos \theta_{I_1}^{E_1} \\
 &= I E_1 \cos \left(\theta + \frac{\alpha}{2} \right) + \frac{E_1 \sin \frac{\alpha}{2}}{z} E_1 \cos \left(\frac{\pi}{2} - \frac{\alpha}{2} - \gamma \right) \\
 &= I E_1 \cos \left(\theta + \frac{\alpha}{2} \right) + \frac{E_1^2 \sin \frac{\alpha}{2}}{z} \sin \left(\frac{\alpha}{2} + \gamma \right) \\
 &= I E_1 \cos \theta \cos \frac{\alpha}{2} - I E_1 \sin \theta \sin \frac{\alpha}{2} \\
 &\quad + \frac{E_1^2 \sin \frac{\alpha}{2}}{z} \sin \frac{\alpha}{2} \cos \gamma + \frac{E_1^2 \sin \frac{\alpha}{2}}{z} \cos \frac{\alpha}{2} \sin \gamma \\
 &= I E_1 \cos \theta \cos \frac{\alpha}{2} - I E_1 \sin \theta \sin \frac{\alpha}{2} \\
 &\quad + \frac{E_1^2 \sin \frac{\alpha}{2}}{z} \frac{r}{z} \sin \frac{\alpha}{2} + \frac{E_1^2 \sin \frac{\alpha}{2}}{z} \frac{x}{z} \cos \frac{\alpha}{2}
 \end{aligned}$$

$$= IE_1 \cos \theta \cos \frac{\alpha}{2} - IE_1 \sin \theta \sin \frac{\alpha}{2} + I_i^2 r + \frac{E_1^2 x}{z^2} \sin \frac{\alpha}{2} \cos \frac{\alpha}{2} \quad (117)$$

$$P_2 = IE_2 \cos \theta \cos \frac{\alpha}{2} + IE_2 \sin \theta \sin \frac{\alpha}{2} + I_i^2 r - \frac{E_2^2 x}{z^2} \sin \frac{\alpha}{2} \cos \frac{\alpha}{2} \quad (118)$$

The term $I_i^2 r$ in equations (117) and (118) does not necessarily represent the copper loss caused by the circulatory current. The copper loss caused by this current is equal to

$$(I + I_i)^2 r - I^2 r.$$

This is not equal to $I_i^2 r$ except when I and I_i are in quadrature.

Since E_1 is the voltage causing the current $(I + I_i)$ in generator No. 1 and $\frac{1}{2}E_0 = \frac{1}{2}(E_1 - E_2)$ is the voltage absorbed in the impedance drop caused by the circulatory current, I_i , the difference between E_1 and $\frac{1}{2}E_0$ or E_{oa} must be the voltage causing the current I . If there were no hunting, $IE \cos \theta$ would be the power developed by each generator. $E = E_1 = E_2$ according to the assumed conditions. The change in the power developed by each generator which is caused by any change in their phase displacement, α , may be found by subtracting $E_1 I \cos \theta$ and $E_2 I \cos \theta$, from equations (117) and (118), respectively. Making this subtraction gives equations (119) and (120) for the change in the power developed by generators No. 1 and No. 2, respectively. In (119) and (120) the subscripts have been dropped from the E 's since, according to the assumed conditions, $E_1 = E_2$.

$$IE \cos \theta (\cos \frac{\alpha}{2} - 1) - IE \sin \theta \sin \frac{\alpha}{2} + I_i^2 r + \frac{E^2 x}{z^2} \sin \frac{\alpha}{2} \cos \frac{\alpha}{2} \quad (119)$$

$$IE \cos \theta (\cos \frac{\alpha}{2} - 1) + IE \sin \theta \sin \frac{\alpha}{2} + I_i^2 r - \frac{E^2 x}{z^2} \sin \frac{\alpha}{2} \cos \frac{\alpha}{2} \quad (120)$$

The first terms and the third terms of expressions (119) and (120) are equal both in magnitude and in sign. Therefore, if the moments of inertia of the generators are equal, these terms

tend to produce equal retarding effects on the angular velocity of the generators and, consequently, cannot influence the relative phase displacement of the generators. Hence, they cannot cause any synchronizing action.

The effect of the first and third terms of (119) and (120) is to cause a slight variation in the angular velocity of the entire system. The period of this variation in the angular velocity is, of course, the same as the period of the hunting. Due to this variation in the angular velocity of the system, the terminal voltage of the system will swing in phase when hunting occurs. This will not influence the hunting between the alternators which are in parallel, but it will tend to start hunting between the alternators and any synchronous apparatus they supply.

Since the first and third terms of (119) and (120) do not affect the synchronizing action of the two alternators, it follows that the second and fourth terms must represent the power acting on each alternator to hold it in synchronism with the other. The synchronizing power, P_s , acting on each of two equal alternators is, therefore

$$P_s = E \left\{ \frac{Ex}{z^2} \cos \frac{\alpha}{2} - I \sin \theta \right\} \sin \frac{\alpha}{2} \quad (121)$$

which is equal to $\frac{P_1 - P_2}{2}$, *i.e.*, to one-half of the difference between the powers developed by the alternators when they are displaced.

The terms $E^2 \frac{x}{z^2} \cos \frac{\alpha}{2} \sin \frac{\alpha}{2}$ and $EI \sin \theta \sin \frac{\alpha}{2}$ in equation (121) represent the synchronizing power due, respectively, to the circulatory current and to the change in the phase angle between E and I .

Equation (121) shows that with constant excitation voltage, *i.e.*, with constant excitation, the synchronizing power and, therefore, the stability of two alternators which are in parallel is greatest when $\sin \theta$ is negative, that is, the stability is greatest with capacity loads. Generators do not operate as a rule with constant excitation but with constant terminal voltage. When the terminal voltage is kept constant the synchronizing power, P_s , corresponding to a given phase displacement, α , is greatest for inductive loads.

If R and X are, respectively, the resistance and the reactance of the load

$$I = \frac{1}{2}I_0 = \frac{E \cos \frac{\alpha}{2}}{\sqrt{(2R + r)^2 + (2X + x)^2}}$$

and

$$\sin \theta = \frac{(2X + x)}{\sqrt{(2R + r)^2 + (2X + x)^2}}$$

Substituting these values in equation (121) gives

$$\begin{aligned} P_s &= E^2 \left\{ \frac{x}{z^2} - \frac{(2X + x)}{(2R + r)^2 + (2X + x)^2} \right\} \sin \frac{\alpha}{2} \cos \frac{\alpha}{2} \\ &= \frac{E^2}{2} \left\{ \frac{x}{z^2} - \frac{2X + x}{(2R + r)^2 + (2X + x)^2} \right\} \sin \alpha \end{aligned} \quad (122)$$

If a short-circuit should occur at the generators, both R and X would be zero and the synchronizing power would reduce to

$$P_s' = \frac{E^2}{2} \left\{ \frac{x}{z^2} - \frac{x}{z^2} \right\} \sin \alpha = 0$$

Under this condition the synchronizing power would be zero and the generators would fall out of step. A short-circuit on the feeders outside of a generating station may decrease R and X sufficiently to so much reduce the synchronizing power as to cause the generators to drop out of step.

To get the synchronizing power in terms of the terminal voltage, V , under steady operating conditions, replace E in equation (122) by V .

When hunting occurs, V will vary in direction and magnitude but E will be constant in magnitude. E will be equal to the terminal voltage, V , before hunting starts plus the impedance drop due to the current, I , carried by either generator under steady conditions.

$$\begin{aligned} E &= V + I(r + jx) \\ V &= I(2R + j2X) = 2I\sqrt{R^2 + X^2} \\ E &= I\sqrt{(2R + r)^2 + (2X + x)^2} \\ E &= \frac{V}{2}\sqrt{\frac{(2R + r)^2 + (2X + x)^2}{R^2 + X^2}} \end{aligned}$$

Putting this value of E in equation (122) gives

$$P_s = \frac{V^2}{8(R^2 + X^2)} \left\{ \frac{x}{z^2} [(2R + r)^2 + (2X + x)^2] - (2X + x) \right\} \sin \alpha$$

$$= \frac{V^2}{8(R^2 + X^2)} \left\{ \frac{x}{z^2} [4(R^2 + X^2) + (r^2 + x^2) + 4(Rr + Xx)] - (2X + x) \right\} \sin \alpha$$

$$= \frac{V^2}{4z^2(R^2 + X^2)} \left\{ 2(R^2 + X^2)x + (x^2 - r^2)X + 2Rrx \right\} \sin \alpha \quad (123)$$

$$= \frac{V^2}{2} \left\{ \frac{x}{z^2} + \frac{(x^2 - r^2)}{2z^2} \frac{X}{(R^2 + X^2)} + \frac{Rrx}{z^2(R^2 + X^2)} \right\} \sin \alpha \quad (124)$$

It should be remembered that V in equations (123) and (124) is the terminal voltage of the generators before hunting starts. This is constant. The actual terminal voltage, as has already been pointed out, varies both in phase and magnitude when hunting occurs. The first term of equation (124) represents the synchronizing power due to the circulatory current. The second and third terms represent the synchronizing power due to the reactive and energy components of the load current, respectively. These last two terms become zero when there is no load on the system. The first term of equation (124) is the most important. The relative importance of the second two depends upon the power factor of the load. The second disappears when the load is non-inductive.

It follows from equation (124) that for any fixed terminal voltage, V , P_s will be greater when X is positive than when negative, provided x is greater than r . Therefore, since the synchronous reactance, x , of alternators is always greater than their resistance, two equal alternators when operated at constant terminal voltage will be more stable on inductive loads than on capacity loads. This statement also holds when the alternators are not equal.

For any fixed ratio of r to x , the synchronizing power will decrease with an increase in either r or z . This may be shown by replacing x in equation (124) by kr where k is a constant. Making this substitution gives

$$P_s = \frac{V^2}{2} \left\{ \frac{1}{r} \left(\frac{k}{k^2 + 1} \right) + \frac{k^2 - 1}{2(k^2 + 1)} \frac{X}{(R^2 + X^2)} + \frac{k}{(k^2 + 1)} \frac{R}{(R^2 + X^2)} \right\} \sin \alpha$$

Effect of Paralleling Two Alternators through Transmission Lines of High Impedance.—When alternators are paralleled through transmission lines, the resistance and the reactance of the lines add directly to the constants of the machines. The easiest way to determine the effect of paralleling through lines of considerable impedance, is to substitute numerical values in equation (124). V in this equation is the potential at the point of paralleling. Assume a 2 per cent. copper loss in each generator at full-load current. According to this assumption Z , of the load, will be $25r$. Let x be $20r$. Then, if the generators are paralleled with no impedance between them on a full kilovolt-ampere load of 0.8 power factor

$$P_s = \frac{V^2}{2r} (0.063) \sin \alpha$$

Let them be paralleled through lines having a .15 per cent. copper loss at full load. The line resistance now will be $7.5r$. If the line reactance is equal to the line resistance

$$P_s = \frac{V^2}{2r} (0.052) \sin \alpha$$

which shows a decrease of about 18 per cent. due to the effect of the line. Unless the excitation of the generators is increased, the potential, V , at the point at which the generators are paralleled will be decreased by the line drop. Any decrease in V will have a marked effect on P_s , since P_s varies as V^2 . The effect of a given line impedance depends upon the ratio of its component parts as well as upon the load power factor. Any increase in line resistance, when the load is either inductive or non-inductive, will decrease the synchronizing action under most conditions. The effect of an increase in the line resistance is most marked where the power factor of the load is low.

Anything which affects the synchronizing power will also affect the period of hunting but in an opposite manner (equation 130, page 362). Due to the decrease in the synchronizing action when generators are paralleled through lines of considerable impedance as well as to the change in the period of hunting, generators paralleled through transmission lines of high impedance may show a tendency to hunt. This, however, does not often occur.

The Relation between r and x for Maximum Synchronizing Action.—The synchronizing power will be a maximum when the term of equation (124),

$$\frac{x}{z^2} + \frac{x^2 - r^2}{2z^2} \frac{X}{R^2 + X^2} + \frac{Rrx}{z^2(R^2 + X^2)}$$

is a maximum. Differentiating this term with respect to x and equating the derivative to zero gives

$$x = r \left\{ \frac{Xr}{R^2 + X^2 + Rr} + \sqrt{1 + \left(\frac{Xr}{R^2 + X^2 + Rr} \right)^2} \right\} \quad (125)$$

for the maximum synchronizing action corresponding to any fixed armature resistance, r . If the load is zero, equation (125) reduces to $x = r$. For any reasonable values of X and R as compared with r , x , according to equation (125), should be very nearly equal to r for maximum synchronizing action. For a power factor of 80 per cent. and a copper loss in the generators of 2 per cent. at full load, equation (125) becomes $x = 1.02 r$. This relation between r and x is of little importance since for best operation other conditions than having P_s a maximum for a given phase displacement, α , call for a ratio of x to r which is very much larger than unity. These other considerations are: the stiffness of coupling, the period of oscillation as a torsional pendulum and the short-circuit current. The resistance, r , must be made as small as possible in order to keep down the copper loss. If x could be made as small as r , the stiffness of coupling between the two alternators would be too great and they would, in consequence, be subjected to very severe strains whenever hunting started or when they were synchronized slightly out of phase. The circulatory current would also be very large even for slight phase displacements. The ratio of the synchronous reactance of ordinary alternators to their effective resistance is always greater than 10 and more often greater than 25.

CHAPTER XXXI

PERIOD OF PHASE SWINGING OR HUNTING; DAMPING; IRREGULARITY OF ENGINE TORQUE DURING EACH REVOLUTION AND ITS EFFECT ON PARALLEL OPERATION OF ALTERNATORS; GOVERNORS

Period of Phase Swinging or Hunting.—If one of two equal alternators which are operating in parallel momentarily changes its angular velocity, synchronizing power will be developed between the two machines according to equation (124), page 358, which will tend to restore them to their proper phase relation. This will cause the machine which lags to speed up and the machine which leads to slow down. Due, however, to the inertia of their moving parts, the generators will swing past the position of no synchronizing action. The synchronizing power will then reverse and tend to pull the generators together again. This action is the same as the hunting which takes place with a synchronous motor. It would continue indefinitely if it were not for the damping action of the losses produced by the hunting in the pole faces and in the dampers in case dampers are used.

The period of hunting can be found in the same way as it was found for a synchronous motor (page 317). If p , f and n are, respectively, the number of poles, the frequency and the number of phases, the synchronizing torque is

$$T_s = \frac{npP_s}{4\pi f} \quad (126)$$

Substituting P_s from equation (124), page 358, in equation (126) and dividing by $\frac{\alpha}{p}$ gives the synchronizing torque developed per unit of space angular displacement of the generators from their mean position.

$$\frac{pT_s}{\alpha} = M = \frac{nV^2p^2}{8\pi f} \left\{ \frac{x}{z^2} + \frac{x^2 - r^2}{2z^2} \frac{X}{Z^2} + \frac{Rrx}{z^2Z^2} \right\} \frac{\sin \alpha}{\alpha} \quad (127)$$

where $Z^2 = R^2 + X^2$.

Since for small angles $\frac{\sin \alpha}{\alpha}$ is nearly equal to unity, equation (127) may be written

$$M = \frac{nV^2 p^2}{8\pi f} \left\{ \frac{x}{z^2} + \frac{x^2 - r^2}{2z^2} \frac{X}{Z^2} + \frac{Rrx}{z^2 Z^2} \right\} \quad (128)$$

The time of oscillation of the rotor of an alternator as a torsional pendulum about its mean angular position is

$$t = 2\pi \sqrt{\frac{\Sigma md^2}{M}} \quad (129)$$

where M and Σmd^2 are respectively, the synchronizing torque per unit angle of phase displacement, and the resultant moment of inertia of the rotor of the generator and the prime mover. Substituting the value of M from equation (128) in equation (129) gives for the approximate time of oscillation

$$t = 2\pi \frac{1}{V} \sqrt{\frac{8\pi f \Sigma md^2}{np^2 \left\{ \frac{x}{z^2} + \frac{x^2 - r^2}{2z^2} \frac{X}{Z^2} + \frac{Rrx}{z^2 Z^2} \right\}}} \quad (130)$$

Equation (130) shows that the period is inversely proportional to the terminal voltage, V , of the system before hunting starts. It is also proportional to the square root of the moment of inertia of the moving parts of the generator and its prime mover. The time of oscillation will increase nearly as the square root of the synchronous reactance of the generators. Putting reactance in series with the generators increases their period of hunting. The period is also affected by the load and its power factor. With fixed terminal voltage, the period increases with an increase in the load. When the load is zero, equation (130) reduces to

$$t = 2\pi \frac{1}{V} \sqrt{\frac{8\pi f z^2 \Sigma md^2}{np^2 x}} \quad (131)$$

Damping.—Synchronous generators which are to be operated in parallel require a certain amount of damping, but as a rule the damping does not need to be so great as for synchronous motors. Generators which are driven by internal-combustion engines are an exception to this rule. Such generators require strong damping. The most common form of damping device

is an amortisseur. An amortisseur for an alternator as a rule, need not be as effective as for a motor, since for a motor it must serve not only for damping out hunting but also as a starting device. The damping action of the hysteresis losses and the eddy currents produced in the pole faces by hunting is often sufficient for alternators. If the ordinary pole-face losses due to the armature slots are eliminated or largely diminished by getting the effect of closed slots by the use of magnetic wedges for holding the armature winding in place, solid poles may be used. Under these conditions, if hunting occurs, large eddy currents will be set up in the solid pole faces by the oscillating armature-reaction field. Very strong damping action may be obtained in this way. It may, in fact, be made large enough to permit its use for damping and for starting synchronous motors as well.

Irregularity of Engine Torque during Each Revolution and Its Effect on Parallel Operation of Alternators.—The turning

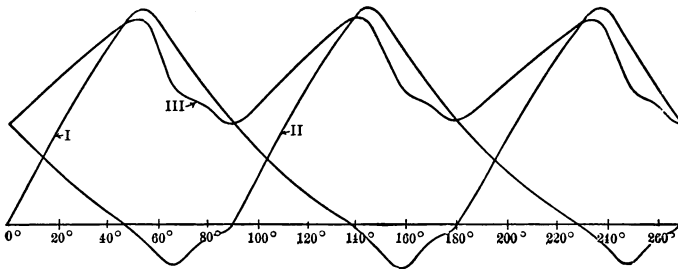

FIG. 177.

moment or torque developed by any reciprocating steam engine or internal-combustion engine is not uniform but goes through a definite cycle in each engine revolution. The form of this cycle depends upon the type of engine and the load it carries. The torque curve of a double-acting single-cylinder engine or of a tandem-compound engine has two maximum and two zero points in each revolution. The torque of a cross-compound engine with 90-degree cranks has four maximum and four minimum points in each revolution but it never falls to zero. Typical torque curves for large slow-speed engines with Corliss valves are shown in Fig. 177. Curve I is for a single-cylinder

or a tandem-compound engine. Curve *III* is for a cross-compound engine with 90 degree cranks. For this curve the power is assumed to be divided equally between the two cylinders. Curve *III* is obtained by adding the ordinates of curve *I* to the ordinates of a similar curve, *II*, which is displaced from curve *I*, by 90 degrees. The torque curve of a high-speed engine will have the same number of maximum and minimum points as the torque curve of a slow-speed engine. Its shape will be different on account of the greater effect of the inertia of the reciprocating parts.

The frequency of the variation in the torque of a cross-compound engine will be twice the frequency of the variation in the torque of a single-cylinder engine or a tandem-compound engine having the same speed, and for the same average turning moment the magnitude of the variation will, as a rule, be less than one-half as great.

A cross-compound engine may have three distinct frequencies of torque variation, namely:

(a) A frequency of one per revolution caused by one end of one cylinder receiving more steam than the other.

(b) A frequency of two per revolution caused by the work being unevenly divided between the cylinders.

(c) A frequency of four per revolution caused by the combined double-frequency torque waves of the two cylinders.

The last of these three frequencies, *i.e.*, four per revolution, is by far the most important. In designing a flywheel for an engine, the maximum variation of the torque must first be found and then the flywheel must be so designed that its moment of inertia when combined with the moment of inertia of the rotor of the generator will limit the variation in the angular velocity during a revolution to some definite prescribed value.

The permissible variation produced by irregularities in the engine torque in the angular velocity of alternators which are to operate in parallel depends upon the frequency of the alternators and the ratio of their short-circuit and full-load currents. Under ordinary conditions, this variation should not be allowed to cause a displacement in the excitation voltage of any alternator from its mean position of much more than $1\frac{1}{4}$ electrical degrees. This corresponds to $\frac{2(1\frac{1}{4})}{p}$ space degrees where p is

the number of poles. The permissible variation in the angular velocity of multipolar generators is very small. For this reason, engines which drive multipolar alternators must have large flywheel action.

The effect of a displacement can readily be seen by referring to equation (124) page 358. For most alternators the ratio of their synchronous reactance to their synchronous impedance is very nearly unity. Making this assumption and neglecting the effect of the load, equation (124) may be written, for small values of the angle, α , in the following approximate form,

$$P_s = \frac{V^2}{2z} \alpha$$

Under ordinary conditions $\frac{V}{z}$ is nearly equal to the short-circuit current, I_{sc} , at full-load voltage. Making this assumption gives

$$P_s = \frac{1}{2} V I_{sc} \alpha, \text{ approximately} \quad (132)$$

Suppose that two similar alternators are paralleled which have short-circuit currents that are equal to three times their full-load currents, and also suppose that the maximum displacement caused by the engines is $1\frac{1}{4}$ electrical degrees. If it happens that the alternators are synchronized in such a way that the engines produce maximum displacements in opposite directions at the same instant, α will be $2(1\frac{1}{4}) = 2.5$ electrical degrees. According to these assumptions

$$P_s = \frac{1}{2} V (3I) (2.5) \frac{2\pi}{360} = 0.065 VI$$

where I is the full-load current. The synchronizing power under this condition is $6\frac{1}{2}$ per cent. of the rated output of each generator. The smaller the short-circuit current, the larger the permissible variation in angular velocity.

The actual variation in the angular velocity, and consequently in the phase displacement produced between the excitation voltages of generators which are in parallel, depends not only upon the magnitudes of the variation in the torques of the engines and the moment of inertias of the flywheels and alternators, but also upon the synchronizing torque of the generators and their damping. The synchronizing torque of an alternator

is nearly proportional to its phase displacement and directly opposes the displacement. On the other hand, the damping action of eddy currents and hysteresis caused by any oscillation of the rotor about its mean angular position as well as the damping action of a damping winding if one is used, is nearly in quadrature with the displacement, and, therefore, nearly in quadrature with the variation in the engine torque.

The curve representing the torque of a reciprocating engine during a revolution may be resolved into a straight line, which

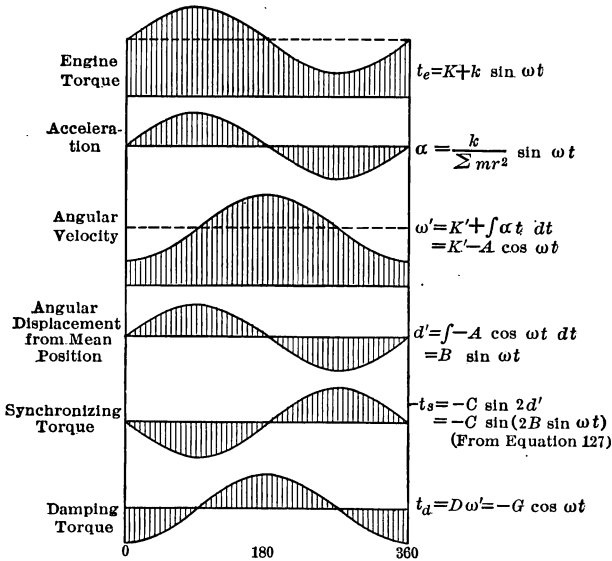

FIG. 178.

represents the mean torque, and an irregular curve which shows the variation of the actual torque from this mean. If the irregular curve is resolved into a fundamental and a series of harmonics and then the latter are neglected, the resulting approximate torque curve becomes a straight line upon which a sine curve is superposed. In a good many cases, this substitution may be made when studying the effect of the variation of the engine torque on parallel operation, but when the harmonics are large, as, for example, when the prime movers are internal-combustion engines, the harmonics must be considered. Fig.

178 shows the curve of the engine torque, neglecting all harmonics, and the corresponding curves of the angular acceleration of the engine, the angular velocity of the engine, the angular displacement of the generator from its mean position, the synchronizing torque, and the damping torque. These curves are plotted one over the other with a common scale of time in order that the phase relations between them may be seen. Equal machines are assumed in the case of the curve of synchronizing torques.

In addition to keeping within certain limits the phase displacement due to the irregularities in the engine torque, it is necessary to make the time of free oscillation of the generator and its flywheel as a torsional pendulum different from any frequency in the torque produced by the engine. If the natural frequency of the oscillation of the generator and its flywheel should coincide with the frequency of any of the engine impulses, violent hunting would occur which would make parallel operation impossible and which might even make it impossible to hold the generators in synchronism. To prevent this resonance between the frequency of the engine torque and the time of oscillation of a generator as a torsional pendulum, care should be taken when designing a flywheel to make the natural frequency of the system at least 20 per cent. lower than the lowest frequency of the impulses from the engine.

Hunting may be caused by any periodic variation in the circuit fed by the alternators as, for example, a periodic variation in the load, but it is seldom that the frequency of the variations in a load will coincide with the natural frequency of the alternators.

Turbines for both water and steam have uniform turning moments. Turbo-driven generators are, therefore, free from hunting caused by their prime movers.

In case alternators which are driven by internal-combustion engines are to be paralleled, it is necessary to provide them with massive flywheels and in addition to use damping grids.

Governors.—Hunting may be caused by improperly designed governors. Governors for engines which are to drive alternators must not be too sensitive and must be sufficiently damped to prevent over-running. If ω_1 and ω_2 represent, respectively, the

maximum and the minimum angular velocity of an engine during a revolution, the mean angular velocity is

$$\omega_m = \frac{\omega_1 + \omega_2}{2}$$

The variation in speed referred to the mean speed is

$$\sigma = \frac{\omega_1 - \omega_2}{\omega_m}$$

This is called the cyclic irregularity of the engine speed. The cyclic irregularity of steam or water turbines is zero. With too sensitive a governor, the cyclic irregularity of engine speed would set up oscillations in the governor and would cause hunting. To avoid this action, governors must be sufficiently damped not to respond to the cyclic irregularity of speed.

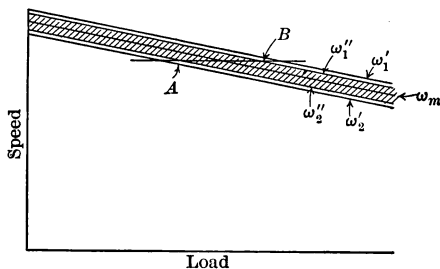

FIG. 179.

Owing to the friction of the parts moved by the governor of any engine or turbine, there must always be a certain change in the speed of an engine or turbine before its governor will act. If, with an engine running at a certain mean speed, ω_m , the greatest and least speeds the engine can have without the governor acting are, ω'_1 and ω'_2 , respectively, then

$$\Delta = \frac{\omega'_1 - \omega'_2}{\omega_m}$$

is what is known as the *coefficient of governor insensitiveness*.

The speeds ω'_1 , ω'_2 and ω_m are plotted in Fig. 179 against loads.

The curves marked ω'_1 and ω'_2 give, respectively, the maximum and the minimum speeds for different loads at which the engine

can operate without action of its governor. If the engine is a reciprocating engine, its speed will vary by an amount equal to $\frac{1}{2}\sigma\omega_m$ above and below its mean speed. Therefore, in order that its speed shall lie within the limits of maximum and minimum speed fixed by the lines marked ω'_1 and ω'_2 , Fig. 179, its average speed during a revolution must always be less than the speed represented by the line ω'_1 and greater than the speed represented by the line ω'_2 by an amount equal to $\frac{1}{2}\sigma\omega_m$. Subtracting $\frac{1}{2}\sigma\omega_m$ from the ordinates of the curve marked ω'_1 and adding it to the ordinates of the curve marked ω'_2 gives curves ω''_1 and ω''_2 . These last two curves show the maximum and minimum mean speeds corresponding to different loads at which the engine can operate without its governor acting. The more sensitive the governor, the closer will be the curves ω'_1 and ω'_2 . Their separation must always be greater than the cyclic irregularity of the engine or the governor will act due to the variation in speed during each revolution. Governors must always be damped sufficiently to make their coefficient of insensitiveness greater than the cyclic variation in the engine speed. If the prime mover is a turbine instead of a reciprocating engine, there will be practically no cyclic variation in its speed and the curves ω'_1 and ω''_1 will coincide as will also the curves ω'_2 and ω''_2 .

When any number of similar alternators which are driven by identical engines are operated in parallel, they will not necessarily share the load equally. Let the horizontal line, AB , Fig. 179, represent the speed of the system. The portion, AB , of this line lying between the curves ω''_1 and ω''_2 represents the possible loads corresponding to the assumed speed. The portion of the line AB included between the two curves ω''_1 and ω''_2 decreases as the slope of the speed-load curve increases. Consequently, the greater the drop in speed for a given increase in the load, the more uniform will be the distribution of the load among the alternators. A very drooping speed characteristic is undesirable on account of the large change in frequency produced by change in load. A speed regulation of about 3 per cent. usually gives satisfactory results.

CHAPTER XXXII

POWER OUTPUT OF ALTERNATORS OPERATING IN PARALLEL AND THE METHOD OF ADJUSTING THE LOAD BETWEEN THEM; EFFECT OF DIFFERENCE IN THE SLOPES OF THE ENGINE SPEED-LOAD CHARACTERISTICS ON THE DIVISION OF THE LOAD BETWEEN ALTERNATORS OPERATING IN PARALLEL; EFFECT OF CHANGING THE TENSION OF THE GOVERNOR SPRING ON THE LOAD CARRIED BY AN ALTERNATOR WHICH IS IN PARALLEL WITH OTHERS

Power Output of Alternators Operating in Parallel and the Method of Adjusting the Load between Them.—The power output of any engine, turbine or motor which does not have a perfectly flat speed-torque curve cannot be changed without altering its speed. All alternators operating in parallel must have the same frequency. Their relative speeds are fixed by the number of poles and cannot be varied so long as the alternators remain in synchronism. Since the relative outputs of the prime movers cannot be changed without altering their relative speeds and since the relative speeds of the alternators are fixed, it follows that nothing can be done to the alternators themselves which will alter the relative amounts of power they receive from the engines or turbines which drive them. A change in the field excitation, and, therefore, in the excitation voltage of an alternator, which is operating in parallel with others, cannot change the amount of power it receives from its prime mover unless the speed of the system is affected. The only thing which can affect the speed is a change in the load on the entire system. This may be caused by the slight change in the terminal voltage of the system which the circulatory current produces. Since the input to the alternator does not change, its output cannot change, except as it is influenced by its copper loss. Therefore, varying the field excitation of an alternator which is in parallel with others will have little or no effect on the load it carries, but it will cause a circulatory current which

is nearly wattless with respect to the terminal voltage of the system. If this circulatory current were not nearly wattless with respect to the terminal voltage, it would cause an energy interchange between the alternators, and, therefore, a change in the distribution of the load between them. This has just been shown to be impossible. The sole effect of the circulatory current when it is produced by an inequality of the excitation voltages, that is, by improper adjustment of the field excita-

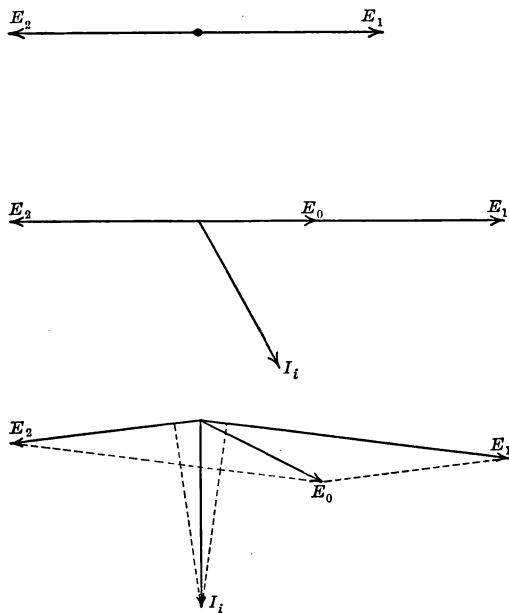

FIG. 180.

tions, is to equalize the terminal voltages. Due to the armature reactions and to the reactive drops caused by the circulatory current, the induced voltages of the alternators with the higher excitation voltages will be lowered and the induced voltages of the alternators with the lower excitation voltages will be raised. The circulatory current which is caused by unequal excitations, therefore, must lag behind the excitation voltages of the alternators which have too high excitation since such lagging current tends to weaken the field. For the same reason it must lead

the excitation voltages of the alternators which have too low excitation. It should be remembered that the circulatory current is not a separate current, but merely a convenient component of the armature current. If more than two machines are in parallel, the circulatory current in the alternators will usually be different.

The effect of changing the excitation of one of two equal alternators which are in parallel is best explained by reference to Fig. 180. This figure is drawn for no load to simplify the explanation. The upper diagram in Fig. 180 shows the conditions existing when the excitation voltages, E_1 and E_2 , are equal and opposite. Each machine is assumed to receive power equal to its losses. If E_1 is increased, there will be a resultant voltage, $E_1 + E_2 = E_o$, acting in the series circuit. This will cause a circulatory current $I_i = \frac{E_o}{2(r + jx)}$, shown in the middle diagram. I_i lags behind E_o by an angle $\tan^{-1} \frac{x}{r}$. It has a component in phase with E_1 and a component in opposition with E_2 .

I_i , therefore, produces generator action on machine No. 1 and motor action on machine No. 2. Since the amount of power each alternator receives from its prime mover has not changed, machine No. 1 will now be developing more power than it receives from its prime mover and will start to slow down. Machine No. 2 will be developing less power than it receives and will start to speed up. These changes in speed will last merely long enough to produce a change in phase between the voltages E_1 and E_2 . E_1 and E_2 will swing to some such positions as are shown in the lower diagram. They will, in fact, swing until the projections of I_i on both E_1 and E_2 are positive and the two projections multiplied by the corresponding voltages are equal. When this condition is reached, there will be no further action to cause any change in the phase displacement of the voltages and the system will be in equilibrium. The whole system will have slowed down very slightly as a result of the increase in the armature copper loss caused by I_i . This should produce an almost imperceptible change in the speed.

When the circulatory current is caused by a difference in phase which is produced between the excitation voltages by the

turbines or engines which drive the generators, it will not be wattless with respect to the terminal voltage. Under this condition it will produce an apparent transfer of energy from some alternators to others. This apparent transfer of energy corresponds to a redistribution of load among the alternators. As has already been said, too much emphasis should not be placed on current interchange as a separate thing as this is apt to lead to an incorrect idea of the actual conditions existing in alternators operating in parallel.

If the prime mover driving an alternator which is in parallel with others is given more steam, the alternator which it drives will receive more power than it delivers and, therefore, start to speed up. If two equal machines are again considered and No. 1 is given more power, the voltage E_1 will swing so as to lead its former position. This condition is represented in Fig. 181.

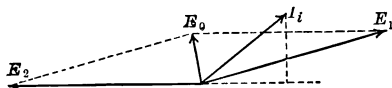

FIG. 181.

The circulatory current, I_i , produced by this change in phase produces generator action with respect to E_1 . E_1 will continue to increase its lead until the power represented by the product of I_i with E_1 is equal to the increase in power given by the prime mover. If there is no load on the system I_i will cause machine No. 2 to be driven as a motor. When the system is loaded, the effect of I_i is to put more load on machine No. 1 and to relieve machine No. 2 of some of its load.

The only way the load carried by an alternator in parallel with others can be increased is by increasing the energy it receives. Turbines or engines driving alternators in parallel must have drooping speed-torque characteristics. In order to deliver more power the engine or the turbine must either slow down or its speed-torque curve must be raised, if a larger torque is to be developed at the same speed. The latter method of increasing the torque is the one which must be used for alternators, since the relative speeds of alternators operating in parallel are fixed and if the speed of one is changed the speed of all must also change in exactly the same proportion since they must all remain in synchronism. Direct-current generators which are in parallel do not have to run at any

definite relative speeds. For this reason, the load carried by a direct-current generator in parallel with others may be increased by increasing its field excitation. Increasing the field excitation puts more load on the prime mover which is free to slow down until it develops the required power. The loads carried by the individual alternators which operate in parallel must be controlled by adjusting the governors of their prime movers, so as to admit more steam at the same speed, if their load is to be increased, or to admit less, if the load is to be decreased. At the same time, the fields of the alternators should be adjusted in order to compensate for the changes in the impedance drops in their armatures. This change in the field excitations will have no effect on the division of the load.

Effect of Differences in the Slopes of the Engine Speed-load Characteristics on the Division of Load between Alternators Operating in Parallel.—To show the effect of the slopes of

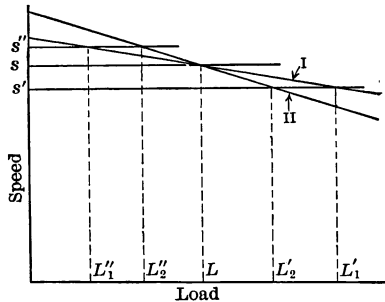

FIG. 182.

the engine characteristics on the distribution of load between two or more alternators in parallel, the slight variation in the distribution of the load which is caused by the lack of sensitiveness of the governors will be neglected. The speed-load curve of any prime mover can, under these conditions, be represented by a single line which corresponds to the mean speed line marked ω_m in Fig. 179, page 368.

Fig. 182 shows two engine speed-load characteristics which are dissimilar. Assume that the alternators have the same number of poles or that the speeds are plotted in terms of frequency.

The speed of both generators and consequently the speed of both prime movers must be equal. At the speed s , both generators carry equal loads. As load is added to the system, the speed will drop. Both generators will still continue to operate at equal speeds, but the speed will be lower than before. Let this new speed be s' . Generator No. 1 is now carrying a load, L'_1 , which is greater than the load, L'_2 . If the load on the system is decreased its speed will rise to some value such as s'' . Generator No. 2 is now carrying the greater load. In general, as the load on a system is increased, the generators driven by the engines having the least drop in their speed-load characteristics will increase their load faster than the generators driven by the engines with the most drooping characteristics. As the

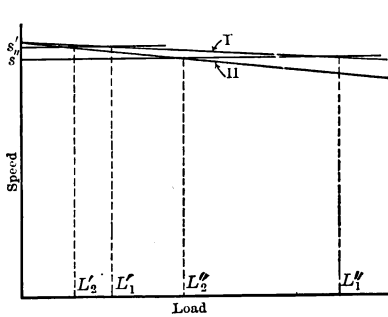

FIG. 183.

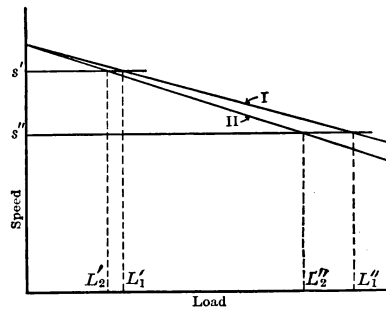

FIG. 184.

load is decreased, the generators driven by the engines with the most drooping characteristics will drop their load slowest. In order that the generators shall divide the load equally, they must be driven by prime movers with identical speed-load characteristics. If the generators are not of the same rating, the speed-load characteristics of their prime movers should be identical when the outputs are plotted in percentage of full load instead of in kilowatts.

The speed-load characteristics of the prime movers should have considerable droop. Too flat characteristics will exaggerate the effect of any slight differences which may exist between the slopes of the characteristics. Perfectly flat characteristics would produce unstable operating conditions. The difference between

the slopes of the characteristics shown in Figs. 183 and 184 is the same but the actual slopes of the characteristics shown in Fig. 184 are greater.

The slopes of the characteristics shown in Fig. 184 are exaggerated in order to emphasize the effect of the droop clearer. It will be seen by referring to Fig. 183 that when the droop in the speed-load characteristics is small, a slight difference between their slopes makes a large difference in the distribution of the load carried by the generators with different total loads on the system. From Fig. 184, it is clear that when the droop is large, the same difference between the slopes of the characteristics has a much less marked effect on the distribution of the load between the two generators. As has already been stated in another connection, the speed-load characteristics of prime movers that are to drive alternators to be operated in parallel

should have drops of about 3 per cent. in speed from no load to full load.

Effect of Changing the Tension of the Governor Spring on the Load Carried by an Alternator which is in Parallel with Others.—The method of adjusting the load carried by an alternator which is in parallel with others has already been given on page

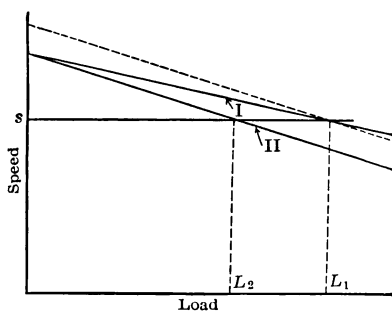

FIG. 185.

370, but just what actually takes place may be made clearer by referring to Fig. 183, which gives the speed-load characteristics for two prime movers.

The characteristics are *I* and *II*. At the speed, *s*, the loads carried by generators No. 1 and No. 2 are, respectively, L_1 and L_2 . If it is desired to make No. 2 increase its load, the tension of its governor spring is increased. This will raise the speed-load characteristic nearly parallel to itself to some new position such as is shown by the dotted line. As the engine must still run at the same speed generator No. 2 now must carry more load. In the case shown, it will carry the same load as the other generator.

CHAPTER XXXIII

EFFECT OF WAVE FORM ON PARALLEL OPERATION OF ALTERNATORS

Effect of Wave Form on Parallel Operation of Alternators.—

If two or more alternators, which have dissimilar wave forms are paralleled, there will be an electromotive force due to the unbalanced harmonics which will cause a circulatory current between the alternators. This circulatory current will serve no useful purpose. Its only effect is to increase the copper loss in the armatures. Suppose two three-phase alternators having the following phase electromotive forces are paralleled.

$$e_a = 3900 \sin \omega t + 195 \sin 3\omega t + 117 \sin \left(5\omega t + \frac{\pi}{6}\right)$$

$$e_b = 3900 \sin \omega t + 19.5 \sin \left(3\omega t + \frac{\pi}{6}\right) + 10 \sin \left(5\omega t - \frac{\pi}{6}\right)$$

The third harmonics cannot appear in the line voltages. If, for the present, the alternators are assumed not to have their neutrals interconnected, the third harmonics will be without effect. If the loads and excitations are adjusted so that the voltages due to the fundamentals are equal and opposite on the series circuit, there will be an unbalanced electromotive force acting in this circuit due to the fifth harmonics. This electromotive force will have a maximum value of

$$E_m = 117 \left(\cos \frac{\pi}{6} + j \sin \frac{\pi}{6} \right) - 10 \left(\cos \frac{\pi}{6} - j \sin \frac{\pi}{6} \right) = 112.3$$

This voltage will cause a fifth-harmonic current to circulate in the armature equal to

$$I_{r.m.s.} = \frac{112}{\sqrt{2} \{ (r' + r'') + j(x'_5 + x''_5) \}}$$

where the r 's are the phase resistances and the x 's are the phase synchronous reactances for the fifth harmonics. The resistances play very little part in determining the magnitude of the

circulatory current and they may be either neglected or assumed to be the same for the harmonics as for the fundamental. The synchronous reactance is made up of two parts: one, x_a , due to slot leakage, and the other x_A , due to armature reaction. The part, x_a , due to slot leakage will usually be five times for the fifth harmonic what it is for the fundamental or, in general, it will be n times for the n th harmonic what it is for the fundamental. The other part, x_A , due to the armature reaction is approximately the same for the fundamental and for all harmonics except the third and its multiples in the case of generators with non-salient poles and distributed armature windings. The term, x_A , for the third harmonic and its multiples is sensibly zero. It follows, therefore, that the synchronous impedance of the armature for any harmonic, except the third and its multiples, is greater than for the fundamental. The circulatory current set up by any harmonic, therefore, will be somewhat less in magnitude than one-half the short-circuit current of the generator multiplied by the ratio of the maximum values of the resultant harmonic and the fundamental. If, in the example taken, the short-circuit current were three times the full-load current, the circulatory fifth-harmonic current would be less than $\frac{112}{3900} \frac{3}{2} (100) = 4.3$ per cent. of full-load current, and the increase in the armature copper loss caused by this current would be less than

$$\left(\frac{(100)^2 + (4.3)^2 - (100)^2}{(100)^2} \right) 100 = \left(\frac{4.3}{100} \right)^2 100 = 0.18$$

per cent. The dissimilarity in wave form ordinarily found in alternators will cause little or no trouble when alternators are paralleled without interconnecting the neutrals.

If the wave forms are the same, any harmonic, with the exception of the third and its multiples, which exists in the phase voltage will, generally, be exaggerated in the circulatory current which flows when the generators are displaced in phase. This follows since any displacement, α , in the phase of the fundamental corresponds to a phase displacement of $n(\alpha)$ in the n th harmonic, but the increase in heating caused by the exaggeration of the harmonic in the circulatory current is insignificant under ordinary conditions.

If the alternators are *Y*-wound and their neutrals interconnected, the effect of any third-harmonic voltage there may be in the coil voltages cannot be overlooked. This is the only condition under which ordinary differences in wave form of alternators in parallel is likely to cause trouble.

If *Y*-wound alternators with like wave forms are put in parallel and their neutrals grounded, there will be no current in the neutral connections except that which may be caused by an unbalanced load on the system, provided, that is, the phase voltages of the alternators are equal and in phase. If the phase voltages are not equal or become displaced in phase, there will be a resultant third-harmonic voltage acting between lines and neutral which will cause a triple-frequency current in each phase. This triple-frequency current is, of course, in addition to the circulatory current produced by the fundamental and harmonics of other frequencies than the third. The triple-frequency currents will all be in phase and will add directly in the neutral. Since the third-harmonic currents in the three phases are in phase, the armature reaction produced by them in the case of an alternator with non-salient poles and a distributed armature winding will be approximately zero. It may be represented as the sum of three equal space vectors differing by 120 degrees in phase. If the generators have salient poles, the triple-frequency currents will produce some armature reaction, but it will be relatively small. Consequently, the reactance for the triple-frequency currents is nearly equal to the slot reactance for the third harmonics. The ratio of synchronous reactance of ordinary alternators to their leakage reactance varies between about two and six roughly. Suppose two equal three-phase *Y*-wound alternators which are in parallel and which have interconnected neutrals become displaced in phase by α degrees. There will then be a triple-frequency current in each phase which is equal to

$$I_3 = \frac{2E'_3 \sin \frac{3\alpha}{2}}{2\sqrt{r^2 + x_3^2}}$$

where I_3 and E'_3 are root-mean-square values. If the ratio of synchronous to slot reactance for the fundamental is assumed

to be a , z_3 will be approximately $\sqrt{r^2 + \left(\frac{3x_1}{a}\right)^2}$. This is approximately equal to $\frac{3z_1}{a}$. Let the ratio of the third harmonic voltage to the fundamental voltage be b . Then

$$I_3 = \frac{a(bE'_1) \sin \frac{3\alpha}{2}}{3z_1}$$

but $\frac{E'_1}{z_1}$ is the short-circuit current, $I_{s.c.}$ for the fundamental voltage and is very nearly equal to the short-circuit current of the alternator. Therefore

$$I_3 = \frac{abI_{s.c.} \sin \frac{3\alpha}{2}}{3}$$

If a and b should be equal to 4 and 0.10, respectively, and the generators should become displaced by 20 degrees, the triple-frequency current would be

$$I_3 = \frac{(4)(0.1)(I_{s.c.})(\frac{1}{2})}{3} = 0.067 I_{s.c.}$$

If the short-circuit current of this machine were three times the full-load current, the third-harmonic current in each phase corresponding to a phase displacement of 20 degrees would be 20 per cent. of the full-load current. The current in the neutral would, of course, be three times the current per phase. With a larger ratio of synchronous reactance to leakage reactance and with a larger short-circuit current, I_3 might easily become equal to the full-load current. The trouble caused by this triple-frequency current is due, not so much to the increase in the armature copper loss it causes as to the tripping out of the circuit breakers when the machines become displaced in phase. This displacement may be produced by hunting, by a sudden change in load, or by careless synchronizing.

The trouble which is caused by the triple-frequency circulatory currents when Y -connected generators with grounded neutrals are paralleled may be avoided in two ways: first, by grounding each generator through a low resistance or reactance; and second, by grounding only one of a group of generators

which are in parallel. The use of resistances or reactances in the ground connections is objectionable on account of the space occupied by the resistances or reactances as well as on account of their expense. With reactance in the ground connections there is danger under some conditions of the production of harmful oscillations. Grounding only one generator at a time does away with the trouble caused by triple-frequency currents in the neutral and at the same time, full protection is given to the system. The current, which can be delivered on short-circuit between any line and neutral, is limited to that which one generator can supply and it will affect only the grounded machine.

CHAPTER XXXIV

A RÉSUMÉ OF THE CONDITIONS FOR PARALLEL OPERATION OF ALTERNATORS; DIFFERENCE BETWEEN PARALLELING ALTERNATORS AND DIRECT-CURRENT GENERATORS; SYNCHRONIZING DEVICES; CONNECTIONS FOR SYNCHRONIZING SINGLE-PHASE GENERATORS; A SPECIAL FORM OF SYNCHRONIZING TRANSFORMER; CONNECTIONS FOR SYNCHRONIZING THREE-PHASE GENERATORS; CONNECTIONS FOR SYNCHRONIZING THREE-PHASE GENERATORS USING SYNCHRONIZING TRANSFORMERS; LINCOLN SYNCHRONIZER

A Résumé of the Conditions for Parallel Operation of Alternators.—Under ideal conditions for parallel operation of alternators, the armature currents carried by the alternators should be in phase when considered with respect to the parallel circuit, and each alternator should carry a current which is proportional to its rating. If the alternators are free from hunting and have like wave form, these conditions can be fulfilled, as has already been explained, by properly adjusting the power outputs of the prime movers and the excitations of the alternators.

Alternators which are to be operated in parallel should have:

1. The same voltage rating.
2. The same frequency.
3. Approximately the same wave form.

It is desirable, but not at all necessary, that they should have synchronous impedances and effective resistances which are approximately inversely proportional to their current ratings.

The prime movers which drive the alternators should have:

1. The same speed-load characteristics.
2. Drooping speed-load characteristics.
3. Constant angular velocity during each cycle.

In addition, the free period of oscillation of the governors of the prime movers and the mechanical period of oscillation of the system must be different from the frequency of any periodic variation in the engine torques, the governors must not be too

sensitive, and the natural electrical and mechanical frequencies of oscillation of the system must be different. If the alternators are *Y*-connected and are to operate with their neutrals interconnected, their wave forms must not contain marked third harmonics.

The necessity for all of the above conditions has been fully explained in the pages which have preceded.

The Difference between Paralleling Alternators and Direct-current Generators.—When paralleling a direct-current generator with others, it is only necessary to bring it up to speed, make its voltage approximately equal to the busbar voltage and then close its main switch. It is, of course, necessary to insure that the polarity of the incoming generator is the same as that of the busbars. The polarity of a direct-current generator does not change under normal conditions, and when a generator has been once correctly wired to the switch which connects it to the busbars it should always build up with the correct polarity unless some abnormal condition occurs to reverse it. Such abnormal conditions are rare.

Paralleling of alternators is somewhat more complicated, for in addition to having equal electromotive forces, their frequencies must be the same. Moreover, the polarity of alternators changes with a periodicity equal to twice their frequency. For this reason, some device is necessary for indicating not only when the frequencies are equal but also when the polarities are the same. In other words, it is necessary to "synchronize" the alternator, which is being put in circuit, with those already operating. Since the relative speeds of direct-current generators which operate in parallel are not fixed, the distribution of load between direct-current generators which are in parallel may be controlled by merely adjusting their field excitations. With alternators the conditions are different, since their relative speeds are fixed. Under ordinary conditions the relative field excitations of alternators which are in parallel have little or nothing to do with the distribution of the load between the machines. The relative field excitations do control the power factors at which the alternators operate. The portion of the total load on the system which is carried by any alternator is controlled solely by the setting of the governor on its prime mover.

Synchronizing Devices.—The simplest form of synchronizer consists of an incandescent lamp connected between the terminals of the generator to be synchronized and the busbars in such a way as to indicate by its brilliancy when the generator is running in synchronism with other generators. Except in the case of low-voltage generators, transformers must, of course, be used with the lamps.

Connections for Synchronizing Single-phase Generators.—Fig. 186 shows the connections for synchronizing a low-volt-

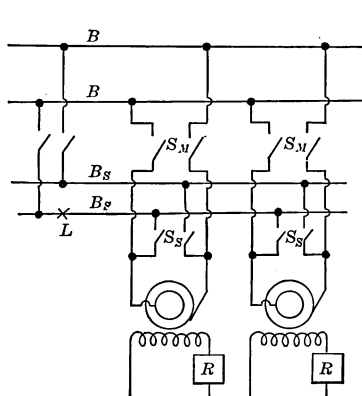

FIG. 186.

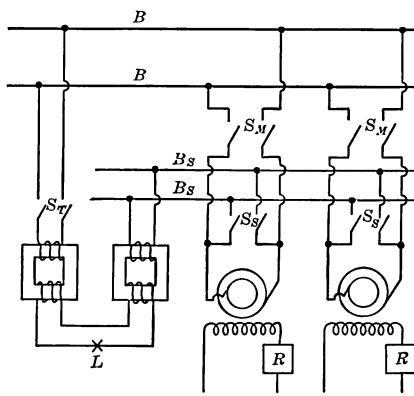

FIG. 187.

age generator without the use of synchronizing transformers. Fig. 187 shows the connections when such transformers are necessary.

When the generators are synchronized without transformers, using the connections shown in Fig. 186, the maximum voltage impressed across the synchronizing lamp is equal to twice the voltage of the generators. The voltage across the lamp will have this value when the generator which is being synchronized is exactly 180 degrees out of phase with the busbar voltage. The lamp will be dark when this generator is in phase with the busbar voltage. If the generator which is being synchronized is running a little fast or a little slow, the lamp will flicker with a frequency equal to twice the difference of the frequencies of the voltages of the busbars and of the incoming generator. Let $e_b = E_m \sin \omega t$ be the voltage of the busbars and let

$e_g = E'_m \sin (\omega \pm \Delta\omega)t$ be the voltage of the generator which is being synchronized, then

$$e_L = e_b + e_g = E_m \sin \omega t + E'_m \sin (\omega \pm \Delta\omega)t$$

will be the voltage across the lamp. If $E_m = E'_m$,

$$e_L = 2E_m \cos \frac{\pm (\Delta\omega)t}{2} \sin \left(\omega \pm \frac{\Delta\omega}{2} t \right) \tag{133}$$

since $\sin a + \sin b = 2 \cos \frac{1}{2} (a - b) \sin \frac{1}{2} (a + b)$

It will be seen from the sine term of equation (133) that the voltage impressed on the lamp has a frequency which is equal

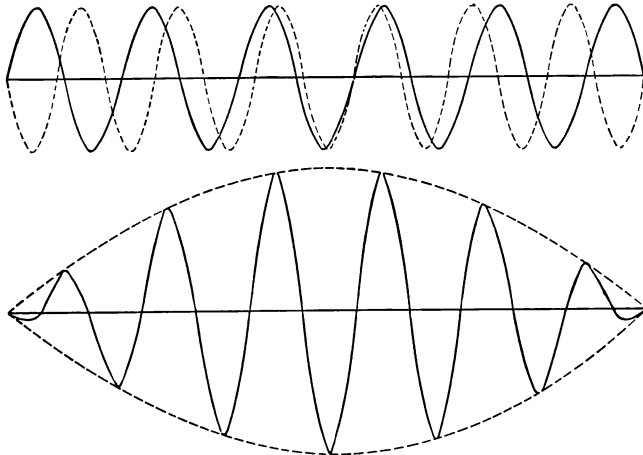

FIG. 188.

to the mean frequency of the voltage of the busbars and of the generator. It will also be seen that the maximum value of each successive voltage wave is different from that immediately preceding it. Equation (133) if plotted, gives a curve like that shown in the lower half of Fig. 188. The upper half of Fig. 188 shows the voltage waves of the generator and the busbars.

The envelope of the lower curve shown in Fig. 188 has for its equation

$$2E_m \cos \frac{\pm \Delta \omega}{2} t$$

Therefore, if the wave forms of the voltages of the busbars and the generator are sinusoidal, the successive maximum values of

the voltage across the lamp will vary according to the cosine law and, since the lamp will be bright once in each half of the cosine wave, the lamp will flicker at the rate of Δf times per second where f is the frequency of the busbar voltage. If the frequency of the busbar voltage is 60 cycles, and that of the generator is 60.3, Δ will be $\frac{0.3}{60} = 0.005$. In this case, the lamp will be bright once in every $3\frac{1}{3}$ seconds. There is, in general, no trouble in making this time interval 9 or 10 seconds or even much greater.

If the connections with transformers are used, the conditions are essentially the same as without transformers, except that the lamp may be either bright or dark for synchronism according to the way the secondaries of the transformers are connected. The maximum voltage which is impressed across the lamp will be equal to twice the secondary voltage of the transformers. When transformers are used, it is usually better to connect them so as to make the lamp bright at synchronism, for it is easier to judge the instant of maximum brightness of the lamp

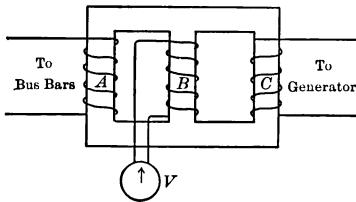

FIG. 189.

than to estimate the middle point of its period of darkness. If the lamp is replaced by a voltmeter, the sensitiveness of the synchronizing device is greatly increased.

A Special Form of Synchronizing Transformer.—The two transformers shown in Fig. 187

may be replaced by a single transformer with three separate windings arranged as shown in Fig. 189.

The branch, B , of the transformer core, forms a return path for the fluxes produced by the exciting windings A and C . If the voltages impressed on these windings are in conjunction, that is, such as to cause upward or downward fluxes in A and C at the same instant, the fluxes caused by them will add directly in the branch B of the core, and the voltage induced in the winding B , which is connected to the voltmeter or lamp, will be a maximum. If the voltages impressed on the two exciting windings A and C are in opposition, the fluxes produced by these

windings will be in opposition in the branch *B* of the core, and will neutralize in that branch. Under this condition, the voltage across the lamp or voltmeter will be zero.

Connections for Synchronizing Three-phase Generators.—The connections for synchronizing two three-phase generators which are of low enough voltage not to require transformers for the synchronizing lamps are shown in Fig. 190.

Closing the synchronizing switch, S_s , for the generator to be synchronized connects it to the synchronizing busbars. When

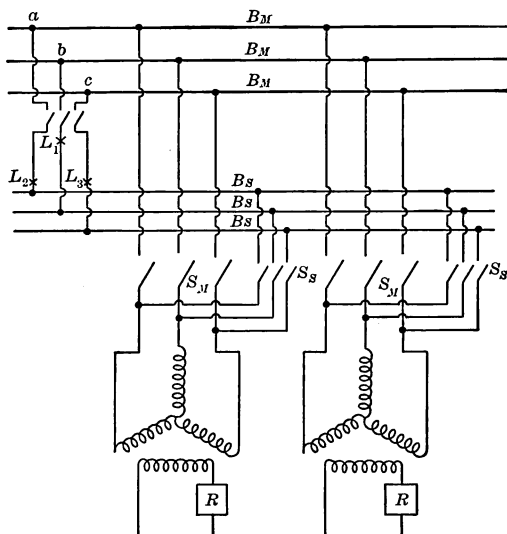

FIG. 190.

the generators are in conjunction, all three lamps will be dark. If the voltage of the generators is too high to be taken directly by the lamps, the lamps may be replaced by suitable transformers with the lamps across their secondaries.

When synchronizing three-phase generators for the first time, it is necessary to synchronize for at least two phases. If a single phase alone is synchronized, the other two phases may be 120 degrees out of phase. After the connections have once been made and have been found to be correct, synchronizing on one phase is sufficient. In spite of this, it is customary to provide synchronizing lamps for all three phases.

With lamps connected as shown in Fig. 190, they will all be dark for synchronism. A better arrangement of lamps, known as the Siemens & Halske arrangement, may be obtained by interchanging the connections of two of the leads from the lamps at either the main busbars or at the synchronizing busbars, for example, by interchanging the connections at *a* and *c*, Fig. 190. With this arrangement of the synchronizing lamps, the lamp L_1 will be dark at synchronism and the lamps L_2 and L_3 will be equally bright but below the maximum candlepower. If the

generator which is being synchronized is running fast or slow, the lamps will glow in rotation and will indicate by the direction of this rotation whether the generator is running fast or slow.

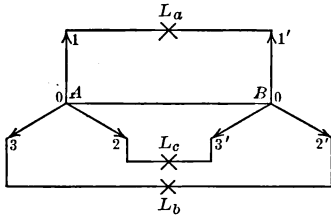

FIG. 191.

It is highly desirable to know whether a generator which is being synchronized is running fast or slow, not only on account of the

time which may often be saved by this knowledge, but also on account of the desirability of having a generator which is being synchronized running fast rather than slow when it is paralleled. If the incoming generator is running slightly fast when put in circuit, the synchronizing action which pulls it into step will put load on it and at the same time this action will relieve the other generators of some of their load. If the incoming generator is put in circuit running slow, it will take motor power to pull it into step.

The effect of interchanging the connections of two of the synchronizing lamps may be seen by referring to Fig. 191.

For simplifying the explanation of this arrangement of the lamps, the generator will be assumed to be connected in Y with interconnected neutrals. In Fig. 191, the vectors, 1, 2 and 3, and 1', 2' and 3' represent the voltages of the generators. When the two generators are in phase, as they are shown in Fig. 191, lamp L_a is subjected to a voltage $V_{01} + V_{1'0} = 0$. The voltages impressed across the lamps, L_c and L_b are, respectively, $V_{02} + V_{3'0} = \sqrt{3}V_{02}$ and $V_{03} + V_{2'0} = \sqrt{3}V_{03}$. If generator *A* is running fast, the voltage across lamp L_b will decrease until

generator A has gained 120 degrees in phase when the voltages $V_{02'}$ and V_{03} will be in phase. At this instant lamp L_b will have a voltage $V_{03} - V_{02'} = 0$ impressed on it and will be dark. The other lamps will be equally bright. When the generator has gained another 120 degrees, lamp L_c will be dark. In other words, the lamps will be dark in succession. If generator A is running slower than B , the order in which the lamps become dark reverses. The lamps may be conveniently placed on the corners of an equilateral triangle, showing by the rotation of brilliancy, whether the generator which is being synchronized is running fast or slow. The proper time to put the incoming generator on the line is when lamp L_a , Fig. 191, is dark, and the other two lamps, L_c and L_b , are equally bright. The maximum voltage to which any lamp will be subjected is twice the Y voltage of the generators. The neutral connection shown in Fig. 191 is not used in practice.

Connections for Synchronizing Three-phase Generators Using Synchronizing Transformers.—If transformers are required for synchronizing the generators as is almost universally the case, it is customary to provide one set for each generator and one set to connect the synchronizing busbars to the main busbars. In this way the synchronizing busbars as well as all synchronizing switches and other synchronizing devices are kept at low voltage. The synchronizing transformers are connected in V to reduce the number required. The proper connections for operating three-phase generators in parallel are shown in Fig. 192.

The connections of the two left-hand synchronizing lamps are reversed from their natural order. This reversed order has already been shown in Fig. 191. With this arrangement lamp b , Fig. 192, will be dark at synchronism. If the sequence of the phases of the generators is a, b, c , a right-handed rotation of the brilliancy of the lamps will indicate that the generator which is being synchronized is running fast. This assumes that the direction of rotation of the generator is right handed. D Fig. 192, is some form of synchronizing device, which will indicate the point of synchronism more closely than the lamps.

The necessity for determining the point of synchronism more exactly than is possible by the use of incandescent lamps has

led to the development of several forms of synchronizing devices of which the Lincoln synchronizer is typical.

Lincoln Synchronizer.—The Lincoln synchronizer is a rotary-field synchronizer indicating by a pointer that moves over a graduated dial the exact difference in phase between the voltage of the generator which is being synchronized and that of the busbars. The direction of rotation of the pointer also indicates whether the generator is running fast or slow. The Lincoln synchronizer is in reality a small motor having a laminated field

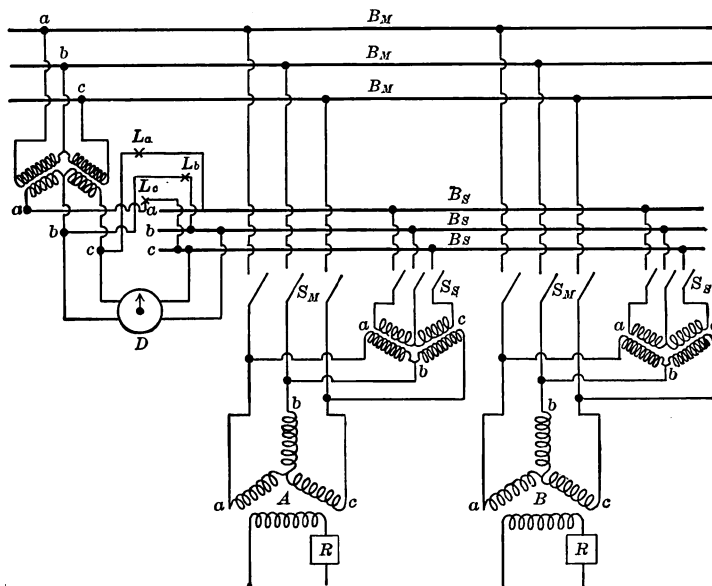

FIG. 192.

excited by the busbars through a large non-inductive resistance. The armature has two windings in space quadrature, excited from the generator to be synchronized; one through a non-inductive resistance, the other, through a reactance. Fig. 193 shows the essential features of this device.

The armature will take up a position with the axis of the field produced by its windings coincident with the axis of the field produced by the poles BB , when the latter field is a maximum. The winding X on the armature is in series with a large reactance and carries a current which is practically in quadrature

with the voltage of the generator. The winding R on the armature is in series with a large non-inductive resistance and the current in it is nearly in phase with the generator voltage. The current in the field coils FF , is nearly in phase with the voltage of the bus-bars. If the voltages of the generator and busbars are in phase, the currents in the field winding FF , and in the armature winding, R , will also be in phase. Under this condition, the armature will take a position such that the magnetic fields due to these two windings coincide. It will, therefore, rotate until the axis of the winding, R , is horizontal, Fig. 193.

If the voltages of the generator and the busbars are 180 degrees out of phase, the axis of the winding R will again be horizontal but the winding will be reversed with respect to its former position. If the voltages are in quadrature, the axis of the winding X will be horizontal. The position of the armature will always indicate the difference of phase between the voltages of the generator and of the busbars. If the frequency of the generator is different than that of the busbars,

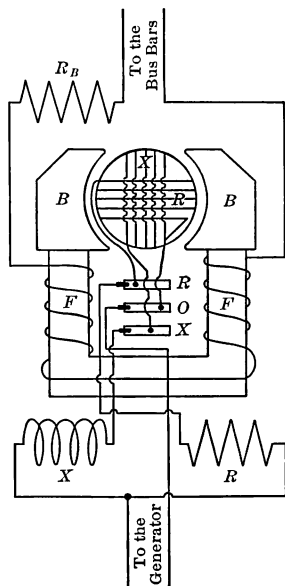

FIG. 193.

the armature will rotate in one direction or the other according as the generator is running fast or slow. The speed of its rotation will be equal to the difference of the frequencies of the voltages of the generator and of the busbars. A pointer attached to the armature indicates on a graduated dial the exact difference in phase between the voltage of the generator being paralleled and that of the busbars.

SYNCHRONOUS CONVERTERS

CHAPTER XXXV

MEANS OF CONVERTING ALTERNATING CURRENT INTO DIRECT CURRENT

Means of Converting Alternating Current into Direct Current.

—Alternating current may be converted into direct current by the use of

- (a) Mechanical rectifiers.
- (b) Mercury arc rectifiers.
- (c) Motor generators.
- (d) Rotary converters.

Mechanical Rectifiers.—On account of sparking, mechanical rectifiers can be used only for small currents and low voltages, and are, therefore, of little practical importance. To operate with minimum sparking, the current must be reversed while passing through its zero value. The point of zero current will not occur at the point of zero voltage, however, except when the circuit is non-inductive. In general, therefore, the brushes will short-circuit the commutator when there is considerable voltage between its two parts. To prevent this short-circuiting, it is necessary to provide an insulated segment between each two adjacent live commutator segments.

Mercury Arc Rectifiers.—At the present time mercury arc rectifiers are commercial for currents up to about 50 amp. and will operate successfully on potentials of 5000 or 6000 volts. Their principal uses are for charging storage batteries and for rectifying current for series arc-light circuits on which the lamps require unidirectional current.

Wherever any large amount of power is to be converted, either motor generators or rotary converters are employed. Both motor generators and rotary converters may be used to convert alternating current to direct current or direct current to alternating current.

Motor Generators.—Motor generators usually consist of an alternating-current motor, of either the synchronous or induction type, coupled directly to a direct-current generator. The chief advantage of motor generators is that their alternating-current and direct-current sides are entirely independent. The relative merits of motor generators and rotary converters will be considered later.

Rotary Converters.—In any direct-current generator the induced voltages are alternating, the current being rectified by means of the commutator. If taps are brought out to slip rings from equidistant points in the armature winding of any two-pole direct-current generator, alternating current may be taken from the slip rings. The number of phases will depend upon the number of taps and except for single phase will be equal to the number of slip rings. If a multipolar generator is used, there will be as many taps per slip ring as there are pairs of poles, assuming a parallel armature winding, such as would ordinarily be used for a rotary converter. A machine tapped in this way will operate either as a direct-current motor or generator, as an alternating-current synchronous motor or generator, as a rotary converter to convert alternating into direct current or to convert direct into alternating current. In most cases, rotary converters are called upon to convert from alternating to direct current. When used for effecting the opposite kind of transformation, *i.e.*, from direct to alternating current, they are said to be run as inverted converters. When converters are run inverted, they must be protected by some form of speed-limiting device. When a converter is used to transform alternating to direct current, it is called a direct converter. It is, however, customary to drop the word “direct” and to speak of it merely as a converter, a rotary converter, or a rotary transformer.

Although any direct-current generator provided with suitable taps and slip rings should theoretically be capable of operating as a converter, in general, its proportions and design would make its operation as a converter unsatisfactory if not quite impossible.

With relation to the external circuits, a rotary converter on its alternating-current side has the characteristics of a synchronous motor and on its direct-current side those of a direct-current generator. In regard to its internal characteristics, it

is radically different from either a synchronous motor or a direct-current generator.

From one point of view the armature of a converter may be considered to carry the difference between the direct current delivered as generator and the alternating current received as motor. As a result, the armature reaction and armature copper loss are neither those of a synchronous motor nor those of a direct-current generator. Except in the case of a single-phase converter the average armature copper loss is less than would be due to either the alternating current or the direct current alone. It follows, therefore, that the output of a converter, the single-phase type excepted, is greater than the output of the same machine operated as generator. This accounts in a large measure for the apparently abnormally large commutators found on rotary converters.

The induced voltage of a direct-current generator depends upon the number of inductors between adjacent brushes, the total flux per pole and the speed. The induced voltage of an alternator depends upon the number of inductors between adjacent taps, the flux per pole and the speed and also upon the distribution of the flux in the air gap. Therefore, since the alternating and direct-current induced electromotive forces of a converter are induced by the same magnetic field and in the same armature winding, it follows that the ratio of the two induced voltages of a converter is fixed for any given flux distribution. Under ordinary conditions of operation, the distribution of the air-gap flux does not change. The rotary converter is, therefore, inherently a machine of fixed voltage ratio.

CHAPTER XXXVI

VOLTAGE RATIO OF AN n -PHASE CONVERTER; CURRENT RELATIONS

Voltage Ratio of an n -Phase Converter.—Let Fig. 194 represent a two-pole converter. The direct-current brushes are assumed to be in the neutral plane, that is, at a and b . R is the direction of the resultant field.

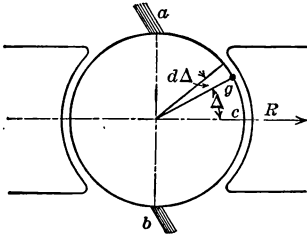

FIG. 194.

Assume that the distribution of the air-gap flux is such as to produce a sine wave of induced electromotive force. The electromotive force induced in any inductor, as at g , is

$$e = E_m \cos \Delta$$

where E_m is the maximum value of the electromotive force induced in a single inductor. The position angle of the inductor g with reference to the resultant field, R , is Δ . The direct-current voltage will be

$$E_{dc} = \sum_{-\frac{\pi}{2}}^{+\frac{\pi}{2}} E_m \cos \Delta$$

$$E_{dc} = \int_{-\frac{\pi}{2}}^{+\frac{\pi}{2}} E_m \frac{Z}{\pi} \cos \Delta d\Delta$$

$$= 2 \frac{Z}{\pi} E_m$$

where Z is the number of inductors in series between brushes.

The maximum value of the voltage induced in the portion of the armature winding between any two adjacent taps will occur when the inductor at the center of that portion of the armature winding lies on the field axis.

If there are n slip rings, the angle between any two taps for

any phase will be $2\frac{\pi}{n}$ electrical radians. If there are more than two poles, n is the number of taps per pair of poles.

The maximum alternating-current voltage between these two taps will be

$$\begin{aligned}
 E'_{ac} &= \int_{-\frac{1}{2}\left(\frac{2\pi}{n}\right)}^{+\frac{1}{2}\left(\frac{2\pi}{n}\right)} E_m \frac{Z}{\pi} \cos \Delta d\Delta \\
 &= 2E_m \frac{Z}{\pi} \sin \frac{\pi}{n}
 \end{aligned}$$

Since a sine wave of electromotive force is assumed, the effective or root-mean-square alternating-current voltage will be

$$E_{ac} = \frac{2E_m \frac{Z}{\pi} \sin \frac{\pi}{n}}{\sqrt{2}}$$

The ratio of the voltages on the two sides of the converter will, therefore, be

$$\begin{aligned}
 \frac{E_{ac}}{E_{dc}} &= \frac{2E_m \frac{Z}{\pi} \sin \frac{\pi}{n}}{2\frac{Z}{\pi} E_m} \\
 &= \frac{1}{\sqrt{2}} \sin \frac{\pi}{n}
 \end{aligned} \tag{134}$$

The ratio of the voltages on the two sides of a converter may also be obtained by taking the ratio of the alternating-current and the direct-current voltages calculated by the usual formulae for the voltages of alternating-current and direct-current generators. The alternating-current voltage for a sinusoidal distribution of the air-gap flux may be found from equation (2), page 21, where N must be the effective number of series armature turns per phase, *i.e.*, the actual number of series armature turns per phase multiplied by breadth factor and pitch factor. The pitch of a converter will be either full pitch or so nearly full pitch that the pitch factor may be assumed to be unity without sensible error. On account of the comparatively large number of armature slots per pole per phase used on converters, the limiting value of the breadth factor for a fixed phase spread may be used in calculating the alternating-current voltage, that is, the value that the breadth factor for a fixed phase spread approaches

as the number of slots per pole per phase increases to infinity. Referring to the equation for the breadth factor on page 41, it will be seen that for fixed phase spread as n , the number of slots per phase, increases, the breadth factor approaches the value

$$k_b = \frac{\sin \frac{\beta}{2}}{\frac{\beta}{2}}$$

as a limit where β is the phase spread expressed in radians. By referring to the table at the bottom of page 41, it will be seen that increasing the number of slots in a given phase spread beyond three or four has little effect on the breadth factor. The phase spread of a converter in radians is always 2π divided by the number of taps per pair of poles. For the formula for the voltage of a direct-current generator, see page 79, Principles of Direct Current Machinery by A. S. Langsdorf.

Let: N = Total number of turns on the armature.

p = Number of poles.

a = Number of parallel paths through the armature winding between direct-current brushes.

φ_m = Flux per pole.

n = Number of taps per pair of poles on the alternating-current side.

Then for a sinusoidal distribution of air-gap flux

$$\begin{aligned} V_{ac} &= \frac{2\pi f}{\sqrt{2}} \times \frac{2N}{an} \times \frac{\sin \frac{\pi}{n}}{\frac{\pi}{n}} \times \varphi_m \\ &= \frac{4fN\varphi_m}{\sqrt{2}a} \times \sin \frac{\pi}{n} \\ V_{dc} &= 4 \frac{N}{a} f\varphi_m \\ \frac{V_{ac}}{V_{dc}} &= \frac{\frac{4fN\varphi_m}{\sqrt{2}a} \times \sin \frac{\pi}{n}}{4 \frac{N}{a} f\varphi_m} \\ &= \frac{1}{\sqrt{2}} \sin \frac{\pi}{n} \end{aligned}$$

which is the same as the expression derived by integration.

A change in the distribution of a given value of air-gap flux will affect only the alternating-current voltage, as the voltage of a direct-current generator with its brushes on the neutral axis depends only on the total flux per pole and not on the distribution of the pole flux. If the distribution of the air-gap flux is not sinusoidal, the alternating-current voltage may be found by resolving the air-gap flux into its fundamental and harmonics and then calculating the alternating-current component voltage corresponding to each component of the flux. The square root of the sum of the squares of these component voltages divided by the direct-current voltage will be the ratio of transformation of the converter.

The actual voltage ratio of a synchronous converter will differ slightly from that given by equation (134), page 397, on account of the influence of the distribution of the air-gap flux. The ratio of the terminal voltages under load will also be slightly influenced by the voltage drops in the armature winding. These drops would be difficult to calculate on account of the peculiar wave form of the armature current (see figures 198 and 199, pages 404 and 405). They are small and are usually neglected. The distribution of the air-gap flux is determined chiefly by the ratio of the pole arc to the pole pitch and by the shape of the pole shoes. Armature reaction plays very little part in determining the distribution of the air-gap flux, since the distorting components of the armature reaction caused by the alternating-current and the direct-current components of the armature current of a synchronous converter are very nearly equal and opposite under steady operating conditions and therefore very nearly cancel. (See page 414, 415 and 416.) These components do not cancel when there is hunting.

The ratio of the effective alternating to direct-current voltage of converters with different numbers of taps is given in Table XVII. The ratios of voltages in this table are for a sinusoidal alternating current voltage. The direct-current brushes are assumed to be in the neutral plane.

It should be noticed that the ratio of the maximum alternating-current voltage to the direct-current voltage of a single-phase converter is unity. In other words, the maximum alternating-

current voltage and the direct-current voltage of a single-phase converter are equal, a sine wave being assumed.

TABLE XVII

No. of taps per pair of poles	No. of phases	$\frac{E_{ac}}{E_{dc}}$
2	1	0.707
3	3	0.612
4	4	0.500
6	6	0.354
12	12	0.183

The ratio of the maximum alternating-current voltage to the direct-current voltage for an n -phase converter with a uniformly distributed winding is equal to the ratio of the chord to the diameter of a circle, where the angle subtended by the chord is equal to the angle in electrical degrees subtended by two adjacent taps on the armature of the converter, sine wave of electromotive force being assumed.

Let the circle shown in Fig. 195 represent the armature of a two-pole n -phase converter. The dots on the circle represent inductors.

The alternating-current electromotive force generated between a and b is equal to the vector sum of the electromotive forces generated in the inductors between a and b . The electromotive force in any inductor, as c , is equal to

$$E_m \cos \Delta$$

Since all the inductors on the armature cut the same flux, the maximum electromotive forces induced in all the inductors are equal. If a polygon is inscribed in the circle shown in Fig. 195 in such a way that its sides are perpendicular to the radii joining the inductors, the projection on the diameter, ab , of any side, such as fh , is equal to $E_m \cos \Delta$, that is, to the electromotive force induced in the inductor, c , at the position shown, provided the scale of the electromotive force is so chosen that the sides of the polygon are equal to the maximum value of the electromotive force induced in the inductors. The maximum value of the electromotive force in a phase containing the inductors, c , d and e will occur when the middle in-

ductor, d , is on the axis of the resultant field R . Therefore, the sum of the three projections, fh , hi and ig on the diameter, ab , is the maximum value of the electromotive force generated in the phase containing the three inductors c , d and e . This is equal to the chord fg . The direct-current voltage is equal to the sum of the electromotive forces between adjacent brushes and is, therefore, equal to the sum of the projections on the diameter, ab , of all the sides of the polygon between the brushes which are at a and b . This is equal to jk . As the number of inductors is increased, jk and fg will approach, respectively, the diameter of the circle and the chord subtended by adjacent taps for the alternating-current slip rings. Therefore, for a rotary with a uniformly distributed armature winding, the ratio of the chord subtended by adjacent alternating-current taps to the diameter of the circle is equal to the ratio of the maximum alternating-current voltage to the direct-current voltage.

For a single-phase, *i.e.*, two-ring, converter, the maximum electromotive force is the diameter ab . Therefore, the ratio of the maximum voltage of an n -ring converter to the maximum voltage of a two-ring converter is equal to the ratio of the length of the chord subtended by two adjacent taps to the length of the diameter of the circle. Since the maximum value of the single-phase voltage is equal to the direct-current voltage, the ratio of the chord to the diameter is also the ratio of the maximum alternating-current voltage of an n -ring converter to its direct-current voltage.

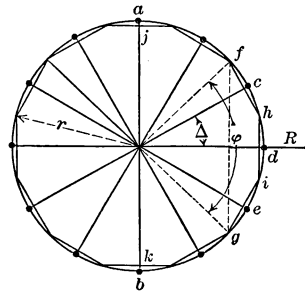

FIG. 195.

The length of the chord subtended by the angle between two adjacent taps of an n -phase converter is

$$\begin{aligned}
 E'_{ac} &= 2r \sin \frac{\varphi}{2} \\
 &= (ab) \sin \frac{\pi}{n}
 \end{aligned}$$

where E'_{ac} and r are, respectively, the maximum phase voltage and the radius of the circle shown in Fig. 195.

The direct-current voltage is equal to the diameter, ab , of this same circle. Therefore, the ratio of the maximum alternating-current voltage to the direct-current voltage is

$$\frac{E'_{ac}}{E_{dc}} = \sin \frac{\pi}{n}$$

and

$$\frac{E_{ac}}{E_{dc}} = \frac{1}{\sqrt{2}} \sin \frac{\pi}{n} \quad (135)$$

is the ratio of the effective alternating-current voltage to the direct-current voltage. This is the relation previously found.

Current Relations.—

Let

- n = Number of slip rings.
- I'_{ac} = Coil alternating current.
- V_{ac} = Phase alternating-current terminal voltage
- $p.f.$ = Power factor.
- p = Number of poles.
- I_{dc} = Total direct current.
- V_{dc} = Direct-current terminal voltage.
- η = Ratio of armature d.c. power to armature a.c. power.

Then, since the input multiplied by the efficiency must be equal to the output, the following relation must hold between the power input and the power output of a two-pole converter.

$$(p.f.) (\eta) n V_{ac} I'_{ac} = V_{dc} I_{dc} \quad (136)$$

If the converter is multipolar, there usually will be as many parallel paths through the armature for each phase as there are pairs of poles. For such a converter equation (136) becomes

$$\frac{p}{2} (p.f.) (\eta) n V_{ac} I'_{ac} = V_{dc} I_{dc}$$

and

$$\frac{\frac{p}{2} I'_{ac}}{I_{dc}} = \frac{1}{n(p.f.) (\eta)} \frac{V_{dc}}{V_{ac}} \quad (137)$$

A converter must be mesh connected since the armature winding of a converter is a direct-current winding which has taps

brought out for alternating current. All ordinary direct-current windings are closed-circuit windings. A Y connection for the converter would necessitate an open-circuit armature winding.

Let the vectors I'_1, I'_2, I'_3, \dots and I'_n , Fig. 196, represent the coil currents of an n -phase mesh-connected converter with p poles.

The line current, I''_{ac} , per pair of poles, from the junction of phase 1 and phase 2, for balanced conditions, will be

$$I''_{ac} = 2I'_1 \sin \frac{\pi}{n} = 2I'_{ac} \sin \frac{\pi}{n}$$

In general the total line current is equal to the coil current multiplied by $2 \sin \frac{\pi}{n}$ and by the number of pairs of poles.

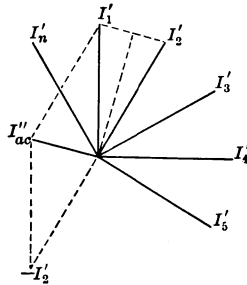

FIG. 196.

Replacing the coil current in equation (137) by the total line current, I_{ac} , gives

$$\frac{I_{ac}}{I_{dc}} = 2 \sin \frac{\pi}{n} \frac{1}{n(p.f.)} \frac{1}{(\eta)} \frac{V_{dc}}{V_{ac}}$$

$\frac{V_{ac}}{V_{dc}}$ is very nearly equal to the ratio of the induced voltages and we may write as an approximation

$$\frac{I_{ac}}{I_{dc}} = 2 \sin \left(\frac{\pi}{n} \right) \frac{1}{n(p.f.)} \frac{1}{(\eta)} \frac{1}{\frac{1}{\sqrt{2}} \sin \frac{\pi}{n}} = \frac{2\sqrt{2}}{n(p.f.)} \frac{1}{(\eta)} \quad (138)$$

This shows that the line currents in converters are inversely proportional to the number of slip rings or inversely proportional to the number of phases except for single phase. Table XVIII gives the ratio of the currents on the two sides of converters

with different numbers of phases. One hundred per cent. efficiency and unity power factor are assumed.

TABLE XVIII

No. of taps per pair of poles	No. of phases per pair of poles	$\frac{I_{ac}}{I_{dc}}$
2	1	1.41
3	3	0.943
4	4	0.707
6	6	0.471
12	12	0.236

It will be seen from Table XVIII that a three-phase converter having an efficiency of 94.3 per cent. and operating at 100 per cent. power factor has equal a.c. and d.c. currents.

CHAPTER XXXVII

COPPER LOSSES OF A ROTARY CONVERTER; INDUCTOR HEATING; INDUCTOR HEATING OF AN n -PHASE CONVERTER WITH A UNIFORMLY DISTRIBUTED ARMATURE WINDING; RELATIVE OUTPUTS OF A CONVERTER OPERATED AS A CONVERTER AND AS A GENERATOR; EFFICIENCY

Copper Losses of a Rotary Converter.—The output of all commutating machines is limited by commutation and by the heating produced by the losses. A large part of the difficulties of commutation in direct-current motors and generators is due to the field distortion produced by armature reaction. Poly-phase rotary converters are almost entirely free from this field distortion. Since motor and generator currents are opposite when considered with respect to the generated voltage, the currents carried by the armature inductors of a rotary converter will be the difference between the alternating-current and direct-current components. The average copper loss produced by the resultant current carried by the inductors is less than would be produced by either component alone, except for a single-phase converter.

The average copper loss is not the same in all the armature inductors of a rotary converter, but varies with the position of the inductors with respect to the taps. The difference between the copper loss in the hottest and coldest inductor depends upon the number of phases for which the converter is tapped and upon the power factor at which it operates. This difference decreases as the number of phases is increased and as the power factor is raised.

Inductor Heating.—Let Fig. 197 represent the armature of a two-pole rotary converter. The direct-current brushes are dd . t_1 and t_2 are two tap inductors. t_o is the inductor midway between the two tap inductors t_1 and t_2 .

The electromotive force induced in the phase between t_1 and

t_2 is a maximum when the axis of the field bisects the angle subtended by the tap inductors t_1 and t_2 . This occurs when t_0 lies on the field axis.

The alternating current in all inductors between t_1 and t_2 is the same at any instant, but it varies as the armature revolves. The phase of the voltage generated in the winding between inductors t_1 and t_2 is the same as the phase of the voltage generated in the inductor t_0 , which is midway between the two taps t_1 and t_2 . Therefore, for unity power factor with respect to the voltage generated in the winding between t_1 and t_2 , the current will be a maximum when t_0 lies on the axis, R , of the field. The alternating current in all inductors between t_1 and t_2 will be zero when the current in t_0 is zero. At unity power factor this will occur when t_0 is under a direct-current brush.

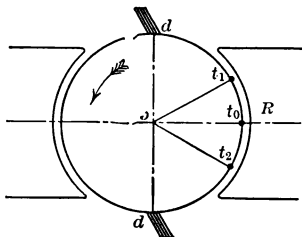

FIG. 197.

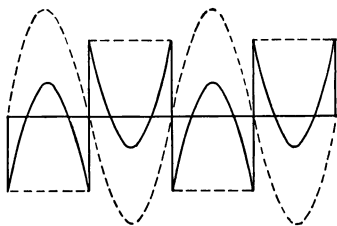

FIG. 198.

The direct current in all inductors on the armature is the same in magnitude, but reverses in direction in each inductor as it passes under a direct-current brush. At unity power factor, the direct and alternating currents in the inductor t_0 will reverse at the same instant. The two currents must be opposite in phase since one represents motor action and the other generator action. Neglecting the effect of the coils short-circuited by the direct-current brushes, the direct-current wave must be rectangular. The dotted lines in Fig. 198 show the direct and alternating currents carried by the inductor t_0 when the power factor with respect to the generated voltage is unity. The full line shows the resultant current.

The direct current in inductor t_1 reverses when t_1 passes under a direct-current brush, but the alternating current, assuming unity power factor, does not reverse until t_0 passes under the

brush. For a three-phase converter, this will occur 60 degrees later.

Fig. 199 shows the resultant and component currents carried by t_1 at unity power factor in a three-phase converter.

It can readily be seen from Figs. 198 and 199 that the root-mean-square currents in inductors, t_o and t_1 , are not the same.

If the current lags behind the generated voltage, the alternating current does not reverse when t_o passes under a brush but reverses later. Considering the inductor t_o , the alternating current reverses later than the direct current and the angle of lag between the reversal of the two currents is the same as the angle of lag between the alternating current and the alternating

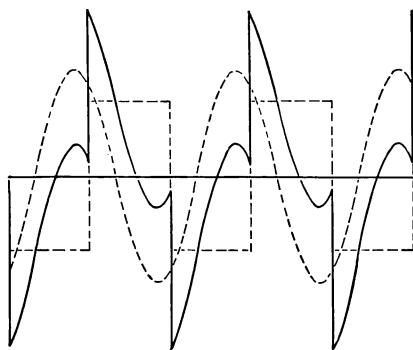

FIG. 199.

electromotive force in the inductor t_o . If the angle of lag were 60 degrees, the current relations for t_o would be the same as those for t_1 shown in Fig. 199, *i.e.*, they would be the same as those existing at unity power factor in an inductor 60 degrees ahead of t_o . In general, the current relations produced in any inductor by a lagging current are the same as those which exist at unity power factor in an inductor which is ahead of the one considered by an angle equal to the angle of lag of the current behind the voltage. For leading current, they would be the same as those in an inductor behind the one considered by an angle equal to the angle of lead between the current and voltage.

Inductor Heating of an n -Phase Converter with a Uniformly Distributed Armature Winding.—Referring to Fig. 200, t_1 and t_2 are taps. c_0 is a point on the armature midway between the two taps t_1 and t_2 . 2α is the phase spread and is equal to $2\frac{\pi}{n}$ where n is the number of taps. When there are more than two poles, n is the number of taps per pair of poles.

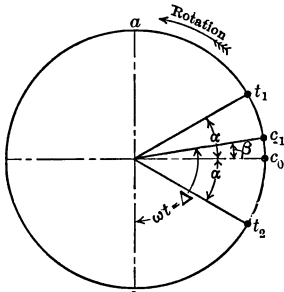

FIG. 200.

The resultant current in any inductor such as c_1 will be

$$\sqrt{2} I'_{ac} \sin (\Delta - \beta - \theta) - \frac{I'_{dc}}{2} \quad (139)$$

where I'_{ac} is the coil value of the alternating current, I'_{dc} the direct current delivered per brush and θ the angle of lag between the alternating current and the generated voltage in the coil c_0 . Each path between any pair of

brushes carries $\frac{1}{p}$ of the total direct current or one-half of the current delivered per brush, p being the number of poles.

The average heating in the inductor c_1 during a cycle is proportional to the mean-square current or to

$$I_c^2 = \frac{1}{\pi} \int_{\Delta=0}^{\Delta=\pi} \left[\sqrt{2} I'_{ac} \sin (\Delta - \beta - \theta) - \frac{I'_{dc}}{2} \right]^2 d\Delta \quad (140)$$

Replacing I'_{ac} by its value in terms of I'_{dc} from equation (137), page 400, remembering that the current I'_{dc} per brush is equal to the total d.c. current, I_{dc} , divided by the number of pairs of poles gives

$$I'_{ac} = I'_{dc} \frac{1}{(p.f.) (\eta) n} \frac{\sqrt{2}}{\sin \frac{\pi}{n}}$$

$$I_c^2 = \frac{I_{dc}^2}{4\pi} \int_{\Delta=0}^{\Delta=\pi} \left[\frac{4 \sin (\Delta - \beta - \theta)}{(p.f.) (\eta) n \sin \frac{\pi}{n}} - 1 \right]^2 d\Delta$$

$$= \frac{I_{dc}^2}{4} \left[\frac{8}{(p.f.)^2 (\eta)^2 n^2 \sin^2 \frac{\pi}{n}} + 1 - \frac{16 \cos (\beta + \theta)}{(p.f.) (\eta) \pi n \sin \frac{\pi}{n}} \right] \quad (141)$$

Since the first term in equation (141) is constant, the copper loss in any inductor, such as c_1 , Fig. 200, will be a maximum when the last term has either its minimum positive or its maximum negative value. It will be negative whenever $\beta + \theta$ is greater than either ± 90 degrees. It is obvious that under ordinary conditions the maximum copper loss will always occur at one of the tap inductors of each phase. At unit power factor the copper loss in all tap inductors will be the same. Under this condition, the minimum copper loss will occur in inductors midway between taps. Except in the case of single-phase converters, and these are never used in practice, the last term of equation (141) is not likely to be negative under commercial operating conditions since converters are never operated at low power factor. The power factor of a converter under load conditions is seldom allowed to get as low as 0.9.

The ratio of the maximum to the minimum inductor heating in three-, four-, six- and twelve-phase converters for unity power factor and for a 90 per cent. power factor, for both lagging and leading current, are given in Table XIX. One hundred per cent. efficiency of conversion is assumed.

TABLE XIX

Number of phases	Ratio of maximum to minimum inductor heating		
	Power factor = 1	Lagging-current, power factor = 0.9	Leading-current, power factor = 0.9
1	6.6	7.4	7.4
3	5.3	8.1	8.1
4	3.6	6.8	6.8
6	2.2	4.9	4.9
12	1.3	2.8	2.8

The ratio of the temperatures of the hottest and coldest inductors will be much less than the ratio of the copper losses given in Table XIX on account of the tendency for the temperature of the inductors to become equalized by heat conduction through the end connections and across the armature teeth.

The copper loss in inductors at different points on the armature of a converter is plotted in Fig. 201. All four curves are for the

same converter operated at a fixed total armature copper loss. The efficiencies and relative outputs for the conditions shown are given on the plots.

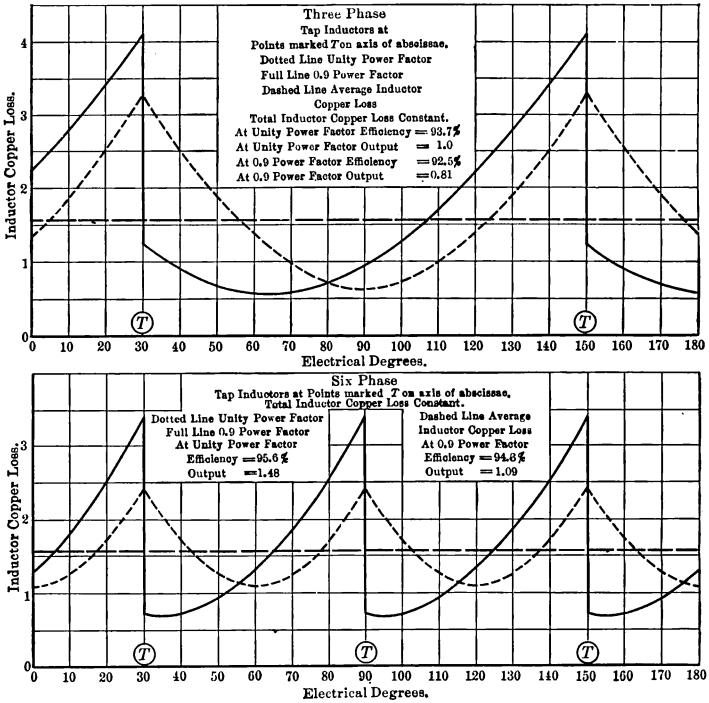

FIG. 201.

Relative Outputs of a Converter Operated as a Converter and as a Generator.—The ratio of the copper loss in the armature of an *n*-phase converter to the copper loss in the same machine when operated as a direct-current generator is given by the ratio of average mean-square current carried by an armature inductor under the two conditions for the same direct-current output. This ratio is given by the following expression.

NOTE.—The current per inductor of the direct-current generator is

$$\frac{I_{dc}}{p} = \frac{I'_{dc}}{2}$$

$$H = \frac{1}{\pi} n \int_{-\frac{\pi}{n}}^{+\frac{\pi}{n}} \left[\frac{8}{(p.f.)^2 \eta^2 n^2 \sin^2 \frac{\pi}{n}} + 1 - \frac{16 \cos(\beta + \theta)}{(p.f.) \eta \pi n \sin \frac{\pi}{n}} \right] d\beta \quad (142)$$

$$\begin{aligned}
 H &= \frac{8}{(p.f.)^2 \eta^2 n^2 \sin^2 \frac{\pi}{n}} + 1 - \\
 &\quad \frac{8}{(p.f.) \eta \pi^2 \sin \frac{\pi}{n}} \left[\sin \left(\frac{\pi}{n} + \theta \right) + \sin \left(\frac{\pi}{n} - \theta \right) \right] \\
 &= \frac{8}{(p.f.)^2 \eta^2 n^2 \sin^2 \frac{\pi}{n}} + 1 - \frac{16}{\pi^2 \eta} \quad (143)
 \end{aligned}$$

The ratio of the outputs for the same copper loss in the armature is the reciprocal of the square root of the ratio of copper losses for the same output. Therefore,

$$\frac{\text{Output of } n\text{-phase rotary}}{\text{Output of a direct-current generator}} = \frac{1}{\sqrt{H}} \quad (144)$$

The outputs of a converter compared with the output of the same machine as a direct-current generator are given by Table XX.

TABLE XX

Number of phases	Relative outputs a.c. to d.c. assuming 100 per cent. efficiency	
	Unit power factor	90 per cent. power factor
1	0.85	0.74
3	1.33	1.09
4	1.65	1.28
6	1.93	1.45
12	2.18	1.58
∞	2.29	1.62

The gain in output by increasing the number of phases decreases rapidly as the power factor decreases.

If converters were operated at low power factors, little would be gained by increasing the number of phases. It is seldom, however, that the power factor of a converter in commercial operation will be as low as 0.9.

The decrease in output with power factor for three- and six-

phase converters is shown by Table XXI in which the output of the converters as direct-current generators is taken as unity.

TABLE XXI

Power factor in per cent.	Relative outputs, a.c. to d.c. assuming 100 per cent., efficiency		
	three-phase	six-phase	twelve-phase
100	1.33	1.93	2.18
95	1.20	1.65	1.83
90	1.09	1.45	1.58
85	0.99	1.28	1.38
80	0.90	1.14	1.22

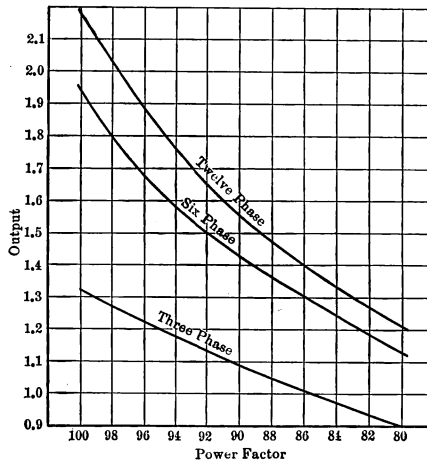

FIG. 202.

The results given in Table XXI are shown plotted in Fig. 202. The outputs at different power factors expressed in per cent. of the output at unity power factor are plotted in Fig. 203.

From Fig. 203 it will be seen that, for a fixed armature copper loss, the percentage decrease in output produced by a decrease in power factor increases slightly as the number of phases is increased.

The difference between the temperature of the hottest and the coldest inductors in the armature of a rotary converter will be less than the difference between the copper losses in these

inductors on account of the equalization of temperature by conduction through the end connections and armature core. In spite of this tendency to equalization, there will still be considerable difference between the temperature of the hottest and coldest inductors under operating conditions. This difference will have to be considered when determining the proper rating for a converter. Since the difference in temperature decreases with increasing number of phases, converters can more safely be given ratings which are determined by their average inductor heating as the number of phases is increased. For this reason the actual gain in output by increasing the number of phases is greater than that indicated in Table XX. It is possible to

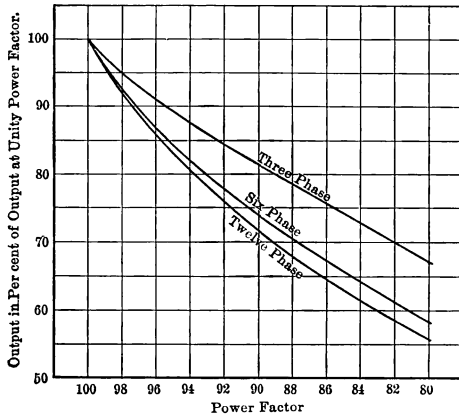

FIG. 203.

equalize in some degree the slot heating by making use of fractional-pitch windings. Pitches which differ much from full pitch cannot, however, be used on account of commutation difficulties. By the choice of a proper pitch, it is possible to make the slot heating of a twelve-phase converter at unit power factor almost uniform.

Efficiency.—Since the output of a polyphase rotary converter for given losses, is greater than the output of the same machine operated as a generator, it follows that the efficiency of a polyphase machine when operated as a converter is greater than when operated as a generator.

Table XXII gives the armature efficiencies and outputs at

unity power factor of a rotary converter, when operated with different numbers of phases and as a direct-current generator. These efficiencies and outputs neglect the increase in commutator friction losses and commutator losses as the number of phases is increased. This increase will be to some slight extent offset by the decrease in the local core losses in the armature and pole faces. No account is taken of the effect on the outputs of the uneven distribution of the armature copper loss.

The output and the efficiency for the direct-current generator are taken as 100 per cent. and 92 per cent., respectively.

TABLE XXII

Machine	Output in per cent.	Efficiency in per cent.
Direct-current generator.....	100	92.0
Three-phase rotary converter.....	133	93.7
Four-phase rotary converter.....	165	94.7
Six-phase rotary converter.....	193	95.6
Twelve-phase rotary converter.....	218	96.0

The increase in the efficiencies of converters of the same rated output would not be so great as the increase shown by Table XXII.

For Example.—Compare the efficiency of a 500-kw. six-phase converter with a 500-kw. generator of the same speed. The converter would have an output as a generator of $\frac{1}{1.93}$ 500 or of about 250 kw. A 500-kw. generator would have an armature efficiency of about 95.2 per cent. The armature efficiency of a 250-kw. generator should be about 90.5 per cent. Assuming that the 500-kw. converter, when operating as a generator, has an armature efficiency of 90.5 per cent., its armature losses as a converter would be $\frac{9.5}{1.93} = 4.9$ per cent. Its armature efficiency as a converter would be 95.1 per cent. or substantially the same as the efficiency of the 500-kw. generator. Although the efficiency of a converter may not be greater than the efficiency of a generator of the same rating, the efficiency of the converter will be greater than the overall efficiency of the generator and motor required to drive it.

Whether the cost of a converter per kilowatt of rating is decreased by increasing the number of phases, depends upon the relative cost of the labor and the material used in its construction. The ratio between labor and material costs increases rapidly as the output is decreased and below outputs of 100 or 200 kw., the cost of adding extra slip rings and increasing the overall length to provide for these usually more than offsets the saving in material in other parts of the converter. Twelve-phase converters will probably not be economical to construct except in very large sizes. In addition to the expense of adding extra slip rings, there will also be a slight increase in the cost of the transformers in some cases. Transformers for three-phase Y or Δ connection and six-phase diametrical connection ought to cost substantially the same, as they differ only in the magnitude of their secondary voltages. Transformers for double Δ and double Y and for twelve-phase connection require two secondary coils and would, therefore, be slightly more expensive than transformers for three-phase or six-phase diametrical connection. The difference in cost, however, would be small.

CHAPTER XXXVIII

ARMATURE REACTION; COMMUTATING POLES; HUNTING; METHODS OF STARTING CONVERTERS

Armature Reaction.—For convenience in considering the armature reaction of a rotary converter, let the armature current be divided into four components, namely:

- (a) The direct current.
- (b) The component, I_q , of the alternating current, which is in quadrature with the generated voltage.
- (c) The component, I_l , of the alternating current which is opposite in phase to the generated voltage and which supplies the rotational losses.
- (d) The remainder, I_e , of the alternating current. This is opposite in phase to the generated voltage and is the component which is effective in producing the direct-current output. I_e is the alternating current the converter would carry at unity power factor if the efficiency were 100 per cent.

Assume a converter with p poles and N uniformly distributed armature turns. The turns per pole and the direct current I'_{dc} , per conductor, will be, respectively, $\frac{N}{p}$ and $\frac{I_{dc}}{p}$. The ampere-turns per pole per elementary angle $d\phi$ on the armature are

$$\frac{I_{dc}}{p} \frac{N}{p} \frac{d\phi}{\pi}$$

These may be resolved into two components, one along the axis of the resultant field, and the other at right angles to this axis. The sum of the components along the field axis taken over any pair of poles will be zero. The other components will all have the same sign and will, therefore, add directly. If ϕ is

the displacement of any armature coil from the field axis (Fig. 204), the sum of these components is

$$\begin{aligned} \frac{I_{dc}}{p} \frac{N}{p\pi} \int_{-\frac{\pi}{2}}^{+\frac{\pi}{2}} \cos \varphi d\varphi \\ = \frac{2}{\pi} \frac{I_{dc}}{p} \frac{N}{p} \end{aligned} \tag{145}$$

This is the direct-current armature reaction per pole. It is at right angles to the resultant field provided the brushes are in the neutral plane.

The armature reaction per pole of any one of the alternating-current components is

$$\frac{0.707NI}{p} \tag{146}$$

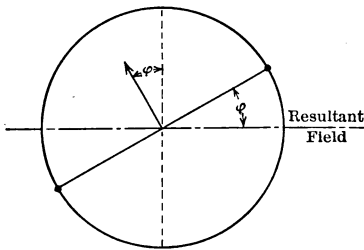

FIG. 204.

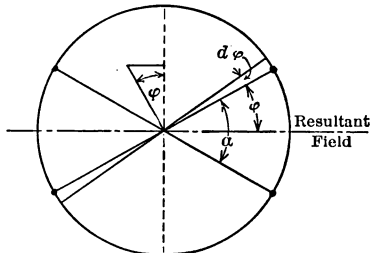

FIG. 205.

where I is the component of the coil current considered. Equation (146) gives the reaction for a concentrated winding and to apply it to the distributed winding of the converter it must be corrected for the phase spread which is $\frac{2\pi}{n}$.

Let α be the phase spread and let the phase contain N' turns per pole and let each turn carry a current I' . If all the turns were concentrated, the reaction per pole per phase would be $0.707N'I'$. Referring to Fig. 205, it will be seen that if the turns are distributed, the reaction becomes

$$\int_{-\frac{\alpha}{2}}^{\frac{\alpha}{2}} \frac{0.707N'I'}{\alpha} \cos \varphi d\varphi = 0.707N'I' \frac{\sin \frac{\alpha}{2}}{\frac{\alpha}{2}}$$

The correction factor is, therefore, $\frac{\sin \frac{\alpha}{2}}{\frac{\alpha}{2}}$

Applying this correction to equation (146) gives

$$\frac{0.707NI}{p} \frac{\sin \frac{\pi}{n}}{\frac{\pi}{n}} \quad (147)$$

for the reaction of any component such as I , of the coil current.

The ratio of the total direct current to the coil alternating current in a converter, assuming the efficiency to be 100 per cent. and the power factor unity is

$$\frac{I'_{ac}}{I_{dc}} = \frac{2\sqrt{2}}{pn \sin \frac{\pi}{n}}$$

where I'_{ac} is the coil alternating current. See equations (134) and (137), pages 397 and 400.

Substituting this current in equation (147), gives the reaction due to the component (d) as

$$\begin{aligned} & \frac{0.707Nn}{p\pi} \frac{2\sqrt{2}I_{dc}}{pn \sin \frac{\pi}{n}} \sin \frac{\pi}{n} \\ & = \frac{2}{\pi} \frac{I_{dc}}{p} \frac{N}{p} \end{aligned} \quad (148)$$

This is the same as the direct-current reaction. It leads the resultant field by 90 degrees. Therefore, the armature reactions of the components (a) and (d) neutralize and there are left only the reaction of the component of the alternating current supplying the rotational losses and the reaction of the quadrature component of the alternating current.

The reaction of the component, I_l , supplying the rotational loss, leads the resultant field by 90 degrees and will produce field distortion. This distortion will be small and will be nearly constant since the rotational losses do not vary greatly under ordinary operating conditions.

The reaction of the remaining component, *i.e.*, of the quadra-

ture current, I_q , will lie along the field axis and will either strengthen or weaken the field according as it lags or leads the voltage required to balance the generated voltage.

The armature reaction of a single-phase synchronous motor or generator is pulsating. Therefore, that part of the armature reaction of a single-phase converter which is due to the alternating current is not constant. Although the resultant of reactions (*a*) and (*d*) will on the average be zero, the actual reaction will fluctuate with double frequency between limits of plus and minus the direct-current reaction. This is due to the maximum value of I_e being equal to twice I_{dc} and opposite to it. Due to the presence of this fluctuating cross field, the commutation of a single-phase converter cannot be made nearly as good as the commutation of a polyphase converter.

Due to the neutralization of the armature reactions produced by the direct current and the load component of the alternating current, converters may be designed with a much larger ratio of armature ampere-turns to field ampere-turns than could safely be employed for direct-current generators. Field distortion does not limit the output of a converter as it does that of a direct-current generator.

Commutating Poles.—Many converters, especially those for 60-cycle circuits, are now designed with interpoles. These interpoles materially improve the operation. Since there is no field distortion under steady operating conditions, the interpoles on a converter need merely produce a field which is sufficient to cause reversal of the current in the coils during commutation. For this reason the interpoles required for a converter are only about 10 or 15 per cent. as strong as those required on a direct-current generator. Converters provided with interpoles should have some device for lifting the direct-current brushes while being brought up to speed by alternating current. This will be discussed under methods of starting converters.

Hunting.—Rotary converters, except when run inverted, are essentially synchronous motors so far as their reaction on the alternating-current line is concerned. The conditions which govern their operation are the same as those which govern the operation of synchronous motors. The cause of hunting and the remedy are the same as for a synchronous

motor. The difficulties due to hunting have been found mainly when rotaries were operated from generators with an angular velocity which was not sufficiently uniform or when they were operated at the end of a transmission line having considerable resistance. Hunting, however, is much more serious in a converter than in a synchronous motor as it causes vicious sparking at the direct-current brushes and is liable to cause "flash over." For this reason, rotary converters are always provided with a damping winding which is more complete than would be required for a synchronous motor of similar dimensions.

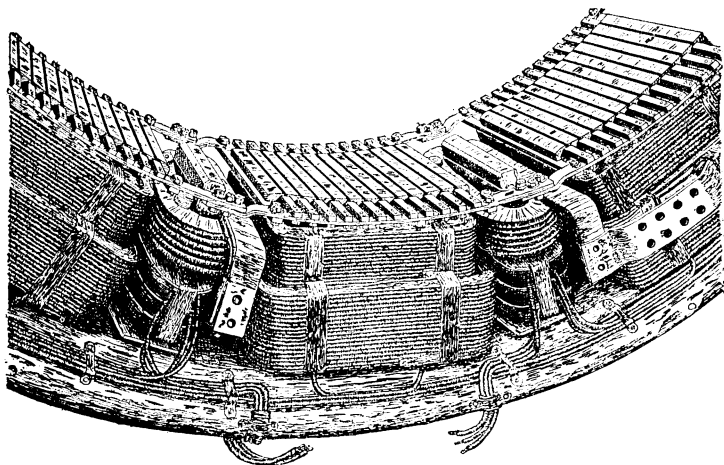

FIG. 206.

A portion of the field of a converter with interpoles and an amortisseur or damper is shown in Fig. 206.

What has been said of armature reaction assumes a steady condition of operation, free from hunting. If hunting occurs, the rotor of the synchronous converter will be alternately ahead and behind its mean position and the power taken on the alternating-current side will alternately be less and greater than the power required for the load and losses. Corresponding to this variation in power, there will be a variation in the energy component of the alternating current which variation will have no equivalent on the direct-current side.

This variation in current will be entirely used in keeping

the converter in step and will produce alternately an acceleration and a retardation of the armature. Since the variation in the alternating current is not balanced by a corresponding change in the direct-current output, it will produce a fluctuating armature reaction which will produce field distortion and cause both the resultant field and also the neutral or commutating zone to sweep backward and forward through their normal positions. The amount of the angular displacement will depend upon the violence of the hunting. If the commutating zone is narrow or the hunting is violent, vicious sparking will result. The effect on commutation is much the same as that which would be produced if the brushes were mechanically oscillated backward and forward about their normal position. The sparking caused by bad hunting will be much exaggerated by the presence of interpoles as they will offer a path of low magnetic reluctance for the fluctuating distorting component of the armature reaction. The variation caused by hunting in the component of the field flux along the axis of the field poles will be largely damped out by the reaction of the currents produced in the amortisseur and in the shunt field winding.

Methods of Starting Converters.—A rotary converter may be started by any of the following methods:

- (a) From its direct-current side as a shunt motor.
- (b) By means of an auxiliary motor mounted on its shaft.
- (c) From its alternating-current side as an induction motor.

This last assumes a polyphase converter.

As a Shunt Motor.—When sufficient direct-current power is available, a converter may be run up to speed as a shunt motor and then synchronized on its alternating-current side like any alternator. If a compound converter is to be started in this way, its compound field must be short-circuited to prevent weakening or even reversal of the field flux due to the starting current in the compound winding which acts differentially while the rotary is operating as a direct-current motor.

All switching on the alternating side of a converter is usually done on the high-tension side of its step-down transformers. Under this condition the secondary windings of the transformers are permanently connected to the slip-rings and form a more or less complete short circuit on the armature when the con-

verter is started as a shunt motor. This short circuit greatly increases the starting current and may make starting as a shunt motor difficult under certain conditions. Certain transformer connections are notably bad in this respect, namely, those in which the secondary windings are connected directly across an electrical diameter of the armature.

By Means of an Auxiliary Motor.—A small induction motor is always used for this purpose. In order to get the converter up to synchronous speed, the induction motor must have fewer poles than the converter, usually two fewer. The converter is brought up to speed by the induction motor. It is then synchronized and connected to the line on its alternating-current side. The proper instant to close the line switch must be determined by some form of synchroscope.

As an Induction Motor.—The shunt field is opened and from one-third to one-half normal voltage is applied to the alternating-current slip rings. When the converter is up to speed, its shunt field is closed and full voltage is applied to the armature. The major part of the starting torque is produced by the induction-motor action in the damping bridges.¹

To prevent puncture of the shunt field winding by the high induced voltage produced in it by the armature-reaction field sweeping by the poles during starting, the shunt field winding should be opened in several places by means of a sectionalizing switch until speed has been reached. In some cases, the field is short-circuited instead of sectionalized. If the converter has a series field which is shunted, the series field with its shunt forms a closed circuit about the poles. To prevent danger to the series field winding or its shunt by the transformer current which would be produced in them during starting, either the series field or its shunt must be opened until the converter is up to speed.

The polarity of a converter which is brought up to speed as an induction motor cannot be predetermined. It is fixed by the direction of the armature reaction with respect to the poles at the instant of closing the field circuit. To obviate this difficulty, the field may be polarized by separately exciting from some source of direct-current power of fixed polarity.

¹ See page 325 under "Synchronous Motors."

Another method of fixing the polarity is to connect a direct-current voltmeter, with the zero point in the middle of its scale, across the terminals of the converter. As synchronous speed is approached, the voltmeter needle will swing slowly back and forth through the zero point of its scale. The field should be closed just as the voltmeter needle starts to swing in the direction indicating the correct polarity.

A converter will always spark while coming up to speed as an induction motor, since every time the armature-reaction field passes through the brush position, the brushes will be on active armature coils. The sparking, as a rule, will not be sufficient to cause damage. Since the reluctance of the path for the armature-reaction field at the instant it passes through the brush position is high, the flux will consequently be low. If, however, interpoles are used, the reluctance of the path in this direction is low and bad sparking will occur.

If a converter with interpoles is to be brought up to speed from its alternating-current side, its brushes must be lifted by some form of brush-lifting device to prevent short-circuit of the armature coils made active by the effect of the armature reaction on the interpoles. One brush in each stud may be made narrow and left on the commutator to provide the necessary current for exciting the shunt field.

When a converter is brought up to speed as an induction motor it will usually be pulled into synchronism by the flux produced in the poles by armature reaction. The voltage induced in the armature winding by this flux is what causes the rotary to build up when its shunt field circuit is closed. If the flux produced by the shunt field opposes that produced by armature reaction it will neutralize the pole flux. There will then be nothing to hold the converter in synchronism and it will start to slow down. It will continue slow until it has slipped approximately 180 degrees, when the armature reaction will have reversed the polarity of the converter and caused it to lock in synchronism. The converter will now start to build up but again the shunt field will oppose the field due to armature reaction and neutralize it. This action will be repeated until the shunt field connections are reversed. Every time the converter slips 180 degrees, there will be bad sparking at the direct-current brushes.

Flash-over.—A converter is much more liable to flash over under abnormal operating conditions than a direct-current generator. Under normal operating conditions the components of armature reaction due to the direct current and the active component of the alternating current nearly neutralize and there is relatively little field distortion. When a short-circuit occurs, a large part of the energy supplied to the short-circuit will momentarily come from the kinetic energy of the rotating armature. Under these conditions the distorting components of the armature current will no longer neutralize and bad field distortion will result. The distortion is momentarily very much worse than would be produced in a direct-current generator under similar conditions, on account of the relatively small air-gap of a converter. Due to the presence of a strong distorting component of the armature reaction, the conditions for commutation are no longer met when a short-circuit occurs and arcing may start at the direct-current brushes. If the voltage produced in the armature coils in the commutating zone, by the badly distorted field, is sufficiently high, the arcs formed at the brushes will persist between commutator bars as the bars leave the brushes and will be carried around the commutator to brushes of opposite polarity. If the arcs thus started are not interrupted before the space between the brushes has been bridged, that is, in less than the time of half a cycle, flash-over will occur. No ordinary form of circuit breaker can open quick enough to remove a bad short-circuit before flash-over can occur. The presence of interpoles will increase the danger of flash-over since they decrease the reluctance of the path of the distorting flux. Special types of quick-opening circuit breakers and insulating barriers between brushes are sometimes used on large converters to prevent flash-over.

A synchronous converter which is operated from a circuit with unbalanced voltages will tend to spark badly even when the applied voltages are only moderately unbalanced. The simplest way to show the cause of this sparking is to resolve the actual applied unbalanced voltages into two systems of balanced voltages of opposite phase order. The first of these systems of voltages will consist of balanced voltages of the same phase order as the applied voltages. These are called the positive-sequence or direct-phase components. The other system of component voltages will consist of balanced voltages of the oppo-

site phase order. These are called the negative-sequence or reverse-phase components. This resolution is much used in handling problems dealing with unbalanced circuits. That such a resolution is possible will be understood by referring to Chapter XII of the author's Principles of Alternating Currents.

The positive-sequence voltages will give rise to balanced component currents in the armature of the converter. These component currents produce the ordinary converter action and the distorting component of the armature reaction due to them is substantially balanced by the component of the armature reaction caused by the direct current. The positive sequence-components will cause no trouble.

The negative-sequence components of the applied voltages will cause balanced component currents in the armature of the converter with a phase order opposite to that of the applied voltages. These negative-sequence component currents will be relatively large even when the negative-sequence components in the applied voltages are small since the apparent impedance to them is low in any machine which has a short-circuited winding like the squirrel-cage winding of an induction motor or the damper of a converter. The negative-sequence component currents in the armature produce a component armature reaction which rotates in the direction opposite to that of the armature and at synchronous speed with respect to it but at double synchronous speed with respect to the field poles and the interpoles. This component of the armature reaction will cause a double-frequency variation in the flux in the field poles and also in the flux in the interpoles. The double-frequency component flux in the field poles will link the short-circuited armature coils which are undergoing commutation and will induce in them double-frequency currents by transformer action. A double-frequency current will also be produced in the field winding. The double-frequency variation in the interpole flux will also induce double-frequency currents in the short-circuited armature coils due to the movement of these coils by the interpoles. Both of the component double-frequency currents in the short-circuited armature coils will be additive. They will have to be interrupted when the coils move out from under the direct-current brushes and will cause bad sparking and may produce flash-over. For this reason, synchronous converters should not be operated from circuits which are likely to have their voltages become much unbalanced.

CHAPTER XXXIX

TRANSFORMER CONNECTIONS; METHODS OF CONTROLLING VOLTAGE; SPLIT-POLE CONVERTER

Transformer Connections.—Since the voltage ratios of rotary converters are fixed by the number of taps for which they are connected, transformers are always necessary in order to operate rotary converters from lines of standard voltages.

Any of the transformer connections given in Chap. XX on Transformers may be used, but certain of these are more common than others. With two exceptions, the method of connecting the primaries of the transformers is immaterial in so far as the converters are concerned. Delta-connected primaries, or *Y*-connected primaries with the neutrals of the generators and transformers grounded, cannot be used with six-phase star-connected secondaries to supply a converter which has a badly distorted wave form. This is on account of short-circuiting by the transformers of the third harmonics in the six-phase voltage of the converter. The six-phase split-pole converter is the only type which is likely to have sufficiently distorted wave form to exclude the two preceding connections.

Either delta or *Y* connection may be used for a three-phase converter. For the six-phase converter, the diametrical connection is the one most often used. This becomes the double *Y* connection if the secondaries are interconnected at their mid-points.

Since the two sides of a rotary converter are in electrical connection, the neutral point of either side must be the neutral point of the other. It follows, therefore, that the neutral point on the direct-current side for a three-wire system may be taken from the neutral point of the secondaries of the transformers, provided they are connected in star.

The simple *Y* connection cannot be used to supply the neutral for a three-phase converter on account of the magnetic unbalancing produced by the direct current in the secondaries of the

transformers. If more than a few per cent. of unbalanced load is to be put on the direct-current side of a three-phase converter, the secondaries of the transformers supplying it should be double and connected in such a manner as to have the magnetic actions of the direct current neutralize in the two secondaries on the same transformer. About 15 per cent. more copper is required for this arrangement than for the simple *Y* connection.

The unbalanced direct current returning by the neutral will divide about equally between the secondaries connected together at the neutral point. The direction of these currents is shown in Fig. 207. The left-hand diagram is the simple *Y*. The right-hand diagram shows double secondaries connected to avoid the change in the magnetic density of the core produced by the direct current with the simple *Y* connection.

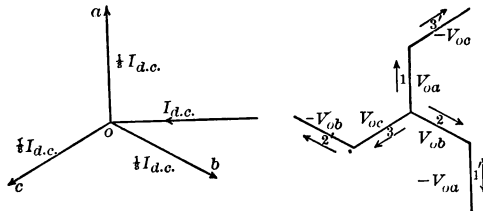

FIG. 207.

From the right-hand figure it will be seen that the two secondaries which are on the same transformer, as for example, 1 and 1', carry direct currents which flow in opposite directions and which will neutralize so far as the magnetic condition of the core is concerned.

Any diametrical connection of secondaries with the middle points of all secondaries interconnected will avoid this magnetic unbalancing. The four-phase star connection and the six-phase double-*Y* or double-*T* connection come under this class.

Methods of Controlling Voltage.—The voltage ratio of any rotary converter, except the split-pole type, is sensibly fixed and is only slightly affected by load and excitation. Any variation in the terminal voltage that may be required must be produced externally to the converter.

If a converter is to be used to deliver direct current, the following methods are available for controlling the direct-current

voltage. All of these change the voltage on the direct-current side by altering the voltage impressed on the alternating-current slip rings.

1. By means of a synchronous booster.
2. By means of an induction regulator.
3. By varying the effect of the impedance drop in a series reactance by altering the power factor of the converter.

A direct-current booster might be used but its expense would be prohibitive. Either method 1 or 2 may be used to control the voltage on the alternating-current side of an inverted converter.

1. *Synchronous Booster*.—The synchronous booster is a low-voltage synchronous generator of the revolving armature type with its armature keyed to the shaft of the rotary converter. The booster must be wound for the same number of phases as the converter and must have the same number of poles. It should be keyed to the shaft in such a position that its induced voltage is either in phase with or in opposition to the induced voltage of the converter. Its voltage will either add to or subtract from the voltage impressed on the converter according to the direction of excitation. The exciting current for the booster field is often passed through an auxiliary winding on the field of the converter. If this auxiliary winding is properly adjusted, the changes in excitation produced by it, when the booster voltage is varied, will maintain the power factor of the unit nearly constant. If the converter has interpoles, an auxiliary winding on these connected in series with the booster field may be made to neutralize the distorting armature reaction caused by the load put on the converter by the booster. The booster acts as a generator or motor and is driven by or drives the converter according as it raises or lowers the voltage.

The chief advantage of the synchronous booster is its flexibility. By its use, the control of voltage and power factor are made independent. It is somewhat more expensive than an induction regulator and considerably more expensive than the series reactance required in the third method of controlling voltage.

2. *Induction Regulator*.—The induction regulator was described on page 238 under "Transformers." Polyphase regulators are used with converters. The regulator is usually placed between the converter and its transformers and in this position

it must be wound for the same number of phases as the converter.

3. *Series Reactance*.—Controlling the voltage of a line by the use of series reactance was mentioned on page 339 under "Synchronous Motors." When reactance is used, it is usually placed in each line between the transformers and the converter. The voltage is controlled by varying the power factor of the converter. For this reason this method of voltage control is not practical except for small changes in voltage. Any attempt to get a greater change than about 10 per cent. above or below normal voltage will materially lower the output of a converter on account of the large decrease in output caused by a decrease in power factor, see Table XXI, page 410. By properly compounding the converter, the voltage regulation may be made nearly automatic. The chief advantage of the series-reactance method of controlling the voltage of the converter is its simplicity and moderate cost. Its disadvantage is its lack of flexibility and its limited range. Neither the power factor nor the voltage can be controlled independently. The one is fixed by the other.

Split-pole Converter.—The voltage on the direct-current side of a rotary converter depends upon the total flux cut by the armature inductors between brushes of opposite polarity and is entirely independent of the manner in which this flux is distributed provided the distribution is such as not to cause the flux to enter the commutating zone. The voltage on the alternating-current side, however, depends not only upon the amount of flux cut but also upon the way in which this flux is distributed. With the same total flux, the wave form and consequently the root-mean-square value of the voltage may be varied by altering the distribution of the flux in the air gap.

There are two ways by which the voltage ratio of a converter with a fixed number of phases may be changed: first, by altering the flux distribution; second, by changing the position of the direct-current brushes with respect to the neutral plane. This latter method when accomplished by an actual movement of the brushes is not practicable on account of the serious sparking which results. The same effect may be obtained, so far as the voltage is concerned by shifting the field with respect to the brushes by electrical means. This may be done without pro-

ducing sparking provided the converter is properly designed. It is not necessary that the direct-current brushes should be in the neutral plane for sparkless commutation provided, however, that the flux at the brush position is of the proper value and sign for commutation. The sign of the flux on opposite sides of any brush may be the same provided the distribution of the flux is such that the field at the brush position is of the correct sign and magnitude for commutation.

The first form of regulating-pole converter built had the field poles divided into three parts, each provided with a main winding and a regulating winding. The three coils of the main winding on each pole were connected in series in such a way as to magnetize all three sections in the same direction and to make the three parts of each pole act as a unit. The coils of the regulating winding were all connected in series, but the two outer sections were arranged to magnetize in opposite direction to the middle section. By varying the excitation of the regulating winding, it was possible to vary the distribution of the air-gap flux without altering the axis of the field or without materially changing the total flux.

The split-pole converter as at present manufactured has each pole divided into two sections. One of these acts as a main pole and the other, considerably smaller, is used as a regulating pole. By varying or reversing the excitation of the regulating or auxiliary pole, the field axis may be shifted. For normal voltage only the main section of the pole is excited. The maximum direct-current voltage will occur when both sections of each pole are excited in the same direction, the minimum when they are excited in opposite directions.

Ordinary converters without interpoles require a slight forward lead of the brushes in order to produce the voltage required for commutation in the coils under the brushes. Since the regulating pole of a split-pole converter varies its strength and also its sign, it is necessary to have the armature of such a converter rotate from the main poles towards the auxiliary poles in order that a forward lead of the brushes will cause the coils undergoing commutation to be a field of fixed polarity and of the right sign. An inverted converter must rotate in the opposite direction, *i.e.*, from the auxiliary poles towards the main poles.

Any distorted wave form may be resolved into a fundamental and a series of harmonics, as for example

$$e = E_1 \sin (\omega t + \alpha_1) + E_3 \sin (3\omega t + \alpha_3) \\ + E_5 \sin (5\omega t + \alpha_5) + \dots + E_n \sin (n\omega t + \alpha_n)$$

A third harmonic cannot exist in the line voltage of a three-phase alternator but it may exist in the phase voltage, page 47. If an alternator which contains a third harmonic in its phase voltage is delta-connected, the third harmonic is short-circuited in the closed delta, and if it is large, the short-circuit current produced by it may cause excessive heating. Although a three-phase rotary converter has a winding which corresponds to the winding of a three-phase alternator, no third harmonic can exist in its phase voltage since the winding of a three-phase converter has a phase spread of 120 degrees. However, a third harmonic may be present in the terminal voltage of a six-phase converter, *i.e.*, between adjacent taps. No harmonic of any order is short-circuited in the armature of any machine with a closed-circuit direct-current armature winding, since the voltages generated in the two halves of such a winding are always exactly equal and opposite and must, therefore, neutralize. Since a converter has a direct-current armature winding, it follows that the distortion of the flux wave of a split-pole converter cannot produce any short-circuit current in its armature winding.

If harmonics exist in the current wave of a circuit which are not present in the corresponding electromotive force wave, they will be wattless with respect to the electromotive force and will merely produce an increase in the copper loss and a decrease in the power factor. If there are harmonics in the electromotive force between the terminals of a converter which are not present in the impressed voltage, a harmonic current of the same frequency will flow due to the unbalanced voltage. As a result of this current, the copper loss of the converter will be increased and its power factor will be lowered. Therefore, if the voltage of a converter is to be varied by altering the distribution of flux in the air gap, the harmonics produced by this in the electromotive force between its terminals must be prevented from producing currents of the same frequency in the converter and in the generators and lines feeding it. This can be accomplished

by using proper transformer connections together with a moderate amount of reactance in series with the converter.

The most important of the harmonics is the third. As has already been stated, this cannot be present between the terminals of a three-phase converter, but it may be present between adjacent or opposite, but not alternate, terminals of a six-phase converter. By choosing proper transformer connections for the six-phase converter, the effect of the third harmonic or any multiple of this harmonic in its terminal voltage may be suppressed in so far as its effects on the converter or the line are concerned. The transformer connections which cannot be used with a six-phase split-pole converter are:

Primaries Δ	}	Secondaries diametrical or double Y with interconnected neutrals.
Primaries Y grounded to the generator neutral		}

Any one of the connections just mentioned will permit a third-harmonic current or its multiples to exist in the converter and transformers and for this reason must not be used. The second connection will in addition permit similar currents to exist in the generator and mains feeding the converter. Any other transformer connection may be used except double T with neutral points connected. Some of the other connections are: primaries in either Y or Δ with secondaries in either double delta or in double Y without interconnection between the two Y 's. A moderate amount of reactance inserted between the line and the converter is desirable in order to diminish harmonic currents of higher orders than the third. A 4 to 6 per cent. reactance is generally sufficient. This is best provided for by designing the transformers which are to be used with split-pole converters with large inherent reactance. The presence of a series reactance is not objectionable so far as its effect on the power factor of the system is concerned, since the power factor of the converter and the reactance as a unit may be kept unity by properly adjusting the field excitation of the converter.

CHAPTER XL

INVERTED CONVERTER; DOUBLE-CURRENT GENERATOR; 60-CYCLE VERSUS 25-CYCLE CONVERTERS; MOTOR GENERATORS VERSUS ROTARY CONVERTERS

Inverted Converter.—When a converter is used inverted, that is, when it is used to transform from direct current to alternating current, certain difficulties arise which are not present when a converter is used to make the opposite transformation. In the latter case, the speed is fixed and any change in the excitation merely alters the power factor. If, however, the converter is operating in parallel with others, a change in its field excitation may also change its load. See page 436.

The conditions existing in an inverted converter are very different from those which exist in a converter delivering direct current. An inverted converter operates as either a shunt or a compound motor and its alternating-current frequency is chiefly dependent upon the strength of its field. An inductive load will weaken the field and cause an inverted converter to increase its frequency. This increase in frequency increases the reactance of the load and this increases the lag of the current which tends to still further increase the speed. The action is cumulative. If a large inductive load is thrown on an inverted converter, there will be a very marked tendency to race. For this reason, all converters which operate inverted must be provided with some form of speed-limit device. A converter which is not run inverted but which operates in parallel with others or with a storage battery may, under certain conditions, become inverted, as for example, if a short-circuit occurs on the alternating-current line. For this reason, it is generally customary to supply speed-limit devices with all rotary converters.

Certain electrical devices may be used to check the tendency of an inverted converter to speed up when an inductive load is applied. For example, a separate shunt exciter mounted on the shaft of the converter will check this tendency, provided this

exciter operates with a low saturation under normal conditions so that its voltage will be very sensitive to increase in speed. Any tendency on the part of the converter to race will produce a rapid increase in the exciter voltage which will increase the excitation of the converter and in a measure check the change in speed.

The voltage ratio, heating, output and efficiency of a converter are substantially the same whether it is operated direct or inverted. The difficulties which arise in the operation of inverted converters are due to instability of speed under inductive loads.

Double-current Generator.—If a rotary converter is driven mechanically, it is capable of delivering either direct current, alternating current, or it may deliver both. When equally loaded on its two sides, its output as determined by the average copper loss in the armature is slightly greater than its output as a direct-current generator except when connected single phase. The gain in output is only about 6.6 per cent. at unity power factor even for the six-phase connection.

If the voltages on the two sides of a double-current generator are to be controlled independently, some device external to the generator, such as an induction regulator, must be used for varying the alternating-current voltage. The direct-current voltage will be changed by the field excitation. This will also affect the voltage on the alternating-current side.

60-Cycle Versus 25-Cycle Converters.—Almost all of the differences between the operation of 60- and 25-cycle converters are due to the difference between the ratio of electrical to mechanical degrees for these frequencies. The early 60-cycle converters were relatively slow-speed machines. For this reason they were unsuccessful.

Low speed and high frequency requires:

1. Many poles and as a result few commutator bars between brushes. Few commutator bars between brushes necessitates high voltage between commutator bars. Under such conditions, any disturbance, such as a sudden change in load or hunting, is liable to cause a flash over.

2. A steep field form with a narrow zone for commutation, Fig. 208.

Increasing the space between poles to give a wider commutating zone requires a greater voltage between commutator bars since the number of active armature coils is diminished. It also decreases the ratio of pole arc to pole pitch and diminishes the output. With slow-speed design, the critical voltage between commutator bars is approached and as a result, a converter designed for low speed is very sensitive to any disturbance, such as hunting, which influences its commutation.

The difficulties of the early 60-cycle converters are avoided in later designs by using higher commutator and peripheral speeds. The higher speeds now possible are due in part to better mechanical design, but more to a better understanding of commutation and to better brushes and brush holders. Higher speeds permit the use of fewer poles. This gives space for a

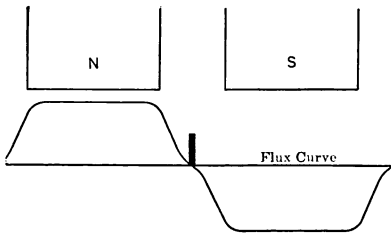

FIG. 208.

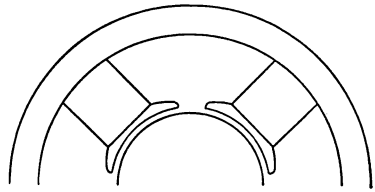

FIG. 209.

greater number of commutator bars which results in lower voltage between bars. Fewer poles permits of a wider commutating zone. Fewer poles also diminishes the magnetic leakage between poles by increasing the spacing at their bases and also permits the use of larger pole shoes. This decreases the leakage and improves the commutating zone. Why greater spacing between poles can be used will be seen by referring to Fig. 209. When many poles are used, the cores become more nearly parallel.

The specific remedy for hunting is the use of damping bridges. Narrow poles such as must be used on slow-speed high-frequency converters do not give much room for damping bars and those bars which can be used are not so effective as with wider poles. The damping bars on a wide and on a narrow pole are shown in Fig. 210.

The difficulties from high mica between commutator segments, which causes jumping of the brushes and sparking, are avoided by undercutting the mica. Undercut mica can be used only when the commutator peripheral speed is relatively high. At low speeds, with undercut mica, the space between the commutator bars will become filled with dust and dirt. The addition of commutating poles assists commutation. It is difficult to find room for such poles on low-speed 60-cycle converters.

The speed of the latest type of 60-cycle converters is nearly double the speed of the early designs. The latest types have from 42 to 48 commutator bars between brushes at 600 volts. Their speed varies from 514 rev. per min. at 1500 kw. to 1200 rev. per min. at 500 kw. The increase in speed is alone mainly responsible for the satisfactory operation of 60-cycle converters.

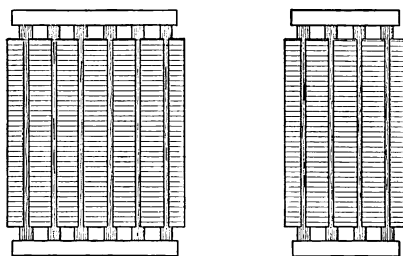

FIG. 210.

Motor Generators Versus Rotary Converters.—In making a comparison of the relative merits possessed by motor-generator sets and rotary converters, only motor-generator sets with synchronous-motor drives will be considered. Motor generators are not started under load and large starting torque, therefore, is not required. Since large starting torque is not required, synchronous motors are usually preferable to induction motors on account of the high power factor at which they may be operated. They also permit of power-factor control. A direct-connected or belted exciter can be provided for the excitation of the synchronous motor.

The constancy of speed of the synchronous-motor drive is a slight advantage when motor-generator sets are to be operated in parallel on their direct-current sides, as it eliminates one

factor which determines the division of load, namely, the difference in the speed characteristics of the motors.

The reliability of a rotary converter is not quite so good as the reliability of either the motor or the generator going to make up a motor-generator set, but when it is considered that the reliability of a motor-generator set depends upon two machines instead of one as in the case of a rotary converter, there probably is not a great deal to choose between the two in this respect, except in the case of 60-cycle sets. In this latter case, the motor generator is probably somewhat more reliable.

The factor of safety in regard to insulation is in favor of the converter, which is of necessity a low-voltage machine. The motor of a motor-generator set would probably be wound for full line voltage up to about 13,500 volts. The factor of safety of the transformers which are used with a rotary converter is too high to have much influence.

Flash over at the commutator is much more apt to occur with rotary converters than with motor generators. There should be no great trouble experienced from this under ordinary conditions of operation, even at 60 cycles, provided the converters are properly designed.

One important advantage of the motor-generator set is the independence of the two sides of the system. The alternating-current and direct-current voltages are entirely independent. A variation of the power factor will have no effect on the direct-current voltage. A change in the frequency will alter the speed of the driving motor and change the voltage of the direct-current generator. No such change of voltage takes place when the frequency impressed on a converter varies. The two sides of a converter with a series synchronous booster are nearly as independent as the alternating- and direct-current sides of a motor generator.

The efficiency of a rotary converter alone is considerably greater than the efficiency of a motor-generator of corresponding speed and capacity, but when comparing the efficiencies of the two it is necessary to include the losses in the transformers and the series reactances and also in the synchronous booster or induction regulator in case either of these is used. Assuming that no transformers are used in connection with a motor

generator, the efficiency of a 25-cycle motor generator will be from 6 to 8 per cent. less than the efficiency of a corresponding rotary converter with its necessary accessories. In the case of 60-cycle apparatus the difference is from 3 to 6 per cent. The copper losses of a motor-generator do not increase so rapidly with decreasing power factor as do the copper losses in a rotary converter.

A 60-cycle rotary converter with its transformers and other auxiliary devices will usually require somewhat less floor space than a motor-generator without transformers and will cost from 25 to 30 per cent. less.

CHAPTER XLI

PARALLEL OPERATION

Parallel Operation.—There is no special difficulty in operating rotary converters in parallel. The rotating parts are lighter than in generators or motor generators of the same rating and for this reason converters respond more quickly to the regulating forces tending to hold them in synchronism.

Converters used for traction work, where the loads are very variable, are usually compounded. In this case, equalizers are required for the same reason as with compound direct-current generators operating in parallel. If the converters are not exactly the same in their electrical characteristics, some may tend to respond to sudden changes of load more quickly than others due to the difference in the speed with which their fields follow any change in series excitation. Any difficulty of this kind is prevented by the use of proper damping bridges.

When rotary converters are to be operated in parallel, it is best to provide each with its separate group of transformers. In case this is not done, separate secondaries should be used for each converter. It may also be desirable to insert a moderate amount of reactance between the rotaries and their transformers to limit interchange of current between them and also to increase their stability. This reactance may be provided for by designing the transformers with a moderate amount of inherent reactance. Series reactance, of course, is necessary whenever voltage control is to be obtained by compounding.

Reverse-current relays should be provided on the direct-current circuit breakers. Speed-limit devices should also be used whenever the conditions of operation are such that it is possible for any of the converters to become inverted. Converters operating in parallel with a storage battery would become inverted if a short-circuit or a heavy overload should occur on the alternating-current line supplying them.

The distribution of load between converters operating in parallel and receiving power on their alternating-current sides can be varied only by changing their direct-current voltages. This may be done in the following three ways:

(a) When there is reactance in series with each converter, by varying their excitations. Increasing the excitation of a converter will make it take a leading current. This will produce a rise of voltage through the series reactance and raise the voltage impressed on the converter.

(b) When induction regulators are provided, by varying the voltages impressed on the converters by means of these regulators.

(c) When the converters are provided with synchronous boosters, by varying the voltages of the converters by changing the excitation of the boosters.

The division of load between inverted converters operating in parallel can be controlled only by changing the phase relation between the induced alternating-current voltages of the converters. Increasing the lead of the induced alternating-current voltage of an inverted converter, which is operating in parallel with other inverted converters, will increase its direct-current output. Weakening the field will tend to make an inverted converter run faster. This will cause the induced voltage to swing in the direction of lead and will therefore increase the output of the converter.

CHAPTER XLII

FIELD EXCITATION AND EFFICIENCY CALCULATED FROM ARMATURE RESISTANCE, WINDING DATA, OPEN-CIRCUIT CORE LOSS AND OPEN-CIRCUIT SATURATION CURVES

Machine.—A 1000-kw., 60-cycle, 600-volt (d.c.) converter will be used. The data relating to this converter are:

Rating.....	1000 kw.
Direct-current voltage.....	600 volts
Alternating-current voltage (diametrical).....	424 volts
Direct-current output.....	1667 amp.
Number of phases.....	6
Frequency.....	60 cycles
Poles.....	12
Speed.....	600 rev. per min.
Number of armature slots.....	180
Inductors per slot.....	6
Armature resistance at 25°C.	
Between d.c. terminals.....	0.00589 ohm.
Between a.c. diametrical terminals.....	0.00589 ohm.
Shunt turns per pole.....	864
Series turns per pole.....	2
Resistance at 25°C. of shunt field.....	39.7 ohms.
Resistance at 25°C. of series winding.....	0.000610 ohm.
Friction and windage loss.....	8.1 kw.

The open-circuit saturation curve and the curve of core loss are plotted in Fig. 211.

Field Excitation.—The armature of a rotary converter carries a current equal to the difference between the components due to the direct-current output and the alternating-current input. As a result, the voltage drops in the armature are relatively small and may be neglected when calculating the field excitation and efficiency without introducing any serious error.

The distorting components of the armature reaction nearly neutralize and need not be considered. The only component of the armature reaction which must be taken into account is that

due to the reactive component of the alternating current. This component either strengthens or weakens the field without

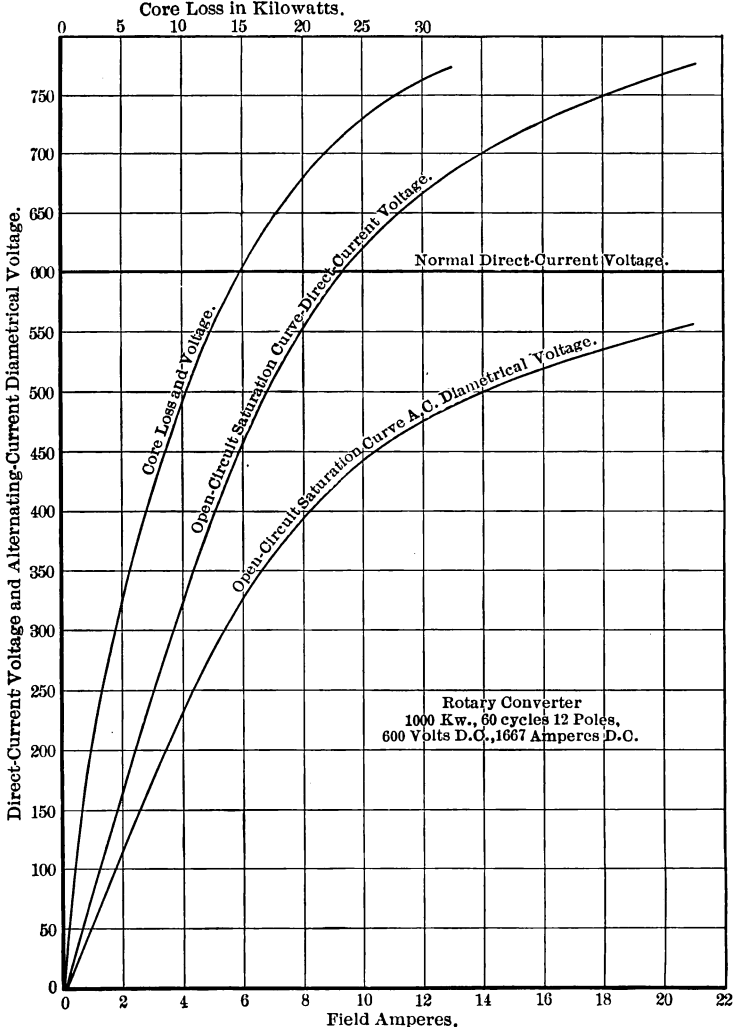

FIG. 211.

producing distortion. The ampere-turns corresponding to it, therefore, add directly to or subtract directly from the

excitation of the shunt and series fields. In the case of a converter delivering direct current, a reactive lagging component of the alternating current strengthens the field. The reactive component of a leading current weakens the field.

The resultant or net ampere-turns of excitation for any terminal voltage under load conditions are approximately equal to the ampere-turns necessary to produce the required voltage when the converter is driven at no load as a generator.

The efficiency of a rotary converter operating at a power factor in the neighborhood of unity is always high at full load. For a large converter it is usually 95 per cent. or better. On account of this high operating efficiency, it is usually close enough to assume the efficiency to be 95 per cent. when calculating the armature reaction caused by the reactive component of the alternating current.

The field excitation for the 1000-kw. converter will be calculated for a full direct-current load and a power factor of 0.95 with a leading current.

The coil alternating current, I'_{ac} , may be found from equation (137), page 400. The coil current is the same as the inductor current.

$$I'_{ac} = I_{dc} \frac{2}{p n (p.f.) \eta} \frac{V_{dc}}{V_{ac}}$$

$$I_{dc} = \frac{1000 \times 1000}{600} = 1667 \text{ amp.}$$

Assuming the efficiency and power factor each to be 0.95

$$I'_{ac} = 1667 \frac{2}{12 \times 6 \times 0.95 \times 0.95} \frac{\sqrt{2}}{\sin \frac{\pi}{n}} = 145 \text{ amp.}$$

The reactive component of this current is

$$I_x = 145 \sqrt{1 - (0.95)^2} = 45.3 \text{ amp.}$$

The armature reaction, A_x , per pole for this current may be found from equation (10), page 59, provided the breadth factor is added to the equation

$$A_x = 0.707 k_b N I_x$$

where k_b is the breadth factor.

The phase spread of a six-phase converter is 60 degrees or one-third of the pole pitch. The converter has 180 slots and 12 poles, or $\frac{180}{12 \times 3} = 5$ slots per phase belt.

From Table I, page 41, the breadth factor for a spread of 60 degrees and four slots per phase is 0.958. For five slots per phase it would be about 0.957.

$$\begin{aligned} A_z &= 0.707 \times 0.957 \times \frac{180 \times 6}{2 \times 12} 45.3 \\ &= 1380 \text{ ampere-turns per pole.} \end{aligned}$$

These are demagnetizing ampere-turns since a leading current was assumed.

The ampere-turns per pole due to the series field are

$$1667 \times 2 = 3334$$

The field current required for 600 volts when the converter is driven at no load as a direct-current generator is 9.25 (open-circuit saturation curve, Fig. 211).

This corresponds to

$$9.25 \times 864 = 7990 \text{ ampere-turns per pole.}$$

The shunt excitation required under full-load conditions at a power factor and efficiency each of 0.95 and with a leading current is

$$7990 + 1380 - 3330 = 6040 \text{ ampere-turns.}$$

This corresponds to a shunt-field current of

$$\frac{6040}{864} = 6.99 \text{ amp.}$$

Efficiency.—The efficiency is

$$\eta = \frac{I_{dc} V_{dc}}{I_{dc} V_{dc} + H I_{dc}^2 r_{dc} + I_{sh} V_{dc} + I_c^2 r_c + P_c + (F + W)}$$

where

I_{dc} = Direct current.

V_{dc} = Direct-current voltage.

r_{dc} = Armature resistance between direct-current terminals.

I_{sh} = Shunt-field current.

I_c = Compound-field current.

r_c = Resistance of compound winding.

P_c = Core loss.

$F + W$ = Friction and windage loss.

The armature copper loss may be found by multiplying the copper loss corresponding to the direct-current component of the armature current by the ratio of the copper loss of the converter as a converter to its copper loss at the same output as a direct-current generator. This ratio, H , may be found from equation (143), page 409,

$$H = \frac{8}{(p.f.)^2(\eta)^2(n)^2 \sin^2 \frac{\pi}{n}} + 1 - \frac{16}{\pi^2 \eta}$$

For a power factor of 0.95 and an assumed efficiency of 0.95

$$\begin{aligned} H &= \frac{8}{(0.95)^2(0.95)^2(6)^2(0.5)^2} + 1 - \frac{16}{(3.142)^2(0.95)} \\ &= 0.385 \end{aligned}$$

The armature resistance at 75°C. between direct-current terminals is

$$0.00589 (1 + 50 \times 0.00385) = 0.00702 \text{ ohm.}$$

The armature copper loss is

$$I_{dc}^2 \times r_a \times 0.385 = (1667)^2 \times 0.00702 \times 0.385 = 7510 \text{ watts.}$$

The ohmic resistance is used in finding the armature copper loss. This loss is small and the error introduced by using ohmic resistance in place of effective is not great. Since the armature inductors of a converter carry differently shaped current waves, the ratio of ohmic to effective resistance would not be the same for all inductors. It would also change with power factor.

The shunt-field loss including the loss in the field rheostat is equal to the shunt-field current multiplied by the voltage across the direct-current brushes. This voltage is equal to the terminal voltage plus the drop in the series field. The drop in the series field will be neglected. The shunt-field loss is, therefore,

$$6.99 \times 600 = 4194 \text{ watts.}$$

The resistance of the whole series field at 75°C. is

$$0.000610 \times (1 + 50 \times 0.00385) = 0.000728 \text{ ohm.}$$

The series-field loss is

$$(1667)^2 0.000728 = 2025 \text{ watts.}$$

The core loss from Fig. 211 corresponding to a direct-current voltage of 600 is 14,700 watts.

The efficiency =

$$\eta = \frac{1000}{1000 + 7.5 + 4.2 + 2.0 + 14.7 + 8.1} = 96.5 \text{ per cent.}$$

POLYPHASE INDUCTION MOTORS

CHAPTER XLIII

ASYNCHRONOUS MACHINES; POLYPHASE INDUCTION MOTOR;
OPERATION OF THE POLYPHASE INDUCTION MOTOR; SLIP;
REVOLVING MAGNETIC FIELD; ROTOR BLOCKED; ROTOR
FREE; LOAD IS EQUIVALENT TO A NON-INDUCTIVE RE-
SISTANCE ON A TRANSFORMER; TRANSFORMER DIAGRAM
OF A POLYPHASE INDUCTION MOTOR; EQUIVALENT CIRCUIT
OF A POLYPHASE INDUCTION MOTOR

Asynchronous Machines.—Up to this point, only machines which operate at synchronous speed have been considered. There is, however, another class known as asynchronous machines. As their name implies, these do not operate at synchronous speed. Their speed varies with the load and may or may not be influenced by the frequency of the circuit to which they are connected. For motors of the series or repulsion types the speed is not so influenced. One distinguishing feature of all commercial synchronous machines is that they require a field of constant polarity excited by direct current. Such a field does not exist in an asynchronous machine. Both parts of an asynchronous machine, *i.e.*, its armature and field, carry alternating current and are either connected in series, as in the series motor, or are inductively related, as in the induction motor. The induction motor and generator, the series and repulsion motors and all forms of alternating-current commutator motors are included in the general class known as asynchronous machines. The induction motor is probably the most important and most widely used type of asynchronous motor. It has essentially the same speed and torque characteristics as a direct-current shunt motor and is suitable for the same kind of work. Its ruggedness

and ability to stand abuse make it a particularly desirable type of industrial motor.

Polyphase Induction Motor.—The induction motor differs from the synchronous motor in that the current in its armature, which is usually the revolving part, is produced by electromagnetic induction while in the synchronous motor it is produced by conduction. The polyphase induction motor is exactly equivalent to a static transformer on a non-inductive load. It is a transformer with a secondary which is capable of rotating with respect to the primary. Although the secondary is usually the rotating part, the motor will operate equally well if the secondary is fixed and the primary revolves. In what follows, the primary will be assumed stationary and will be referred to as the primary, the stator or the field. The secondary, which in this case will rotate, will be called the secondary, the rotor, or the armature. The terms primary and secondary are perfectly definite, meaning respectively the part which receives power directly from the mains and the part in which the current is produced by electromagnetic induction. The terms stator and rotor are not so definite, since their significance is not determined by the electrical connections, but merely by the particular part which is stationary.

Operation of the Polyphase Induction Motor.—The stator winding of a polyphase induction motor is similar to the armature winding of a polyphase alternator. This winding produces a rotating magnetic field which corresponds to the armature reaction of the alternator. As with the armature reaction of an alternator, the fundamental of this field revolves at synchronous speed with respect to the stator. With respect to the rotor it revolves at a speed which is the difference between the synchronous speed and the speed of the rotor. This difference is known as the slip. A portion of the stator of an induction motor with a few coils in place is shown in Fig. 212.

The rotor winding will have as many poles as the stator and will have currents induced in it by the revolving magnetic field. These currents will cause the rotor to revolve in the same direction as the magnetic field set up by the stator. If it were not for rotational losses, synchronous speed would be reached at no load. Under load conditions, the difference between the speeds of the magnetic field and of the rotor will be just sufficient to

cause enough current to be induced in the rotor to produce the torque required for the load and to overcome the rotational losses.

The speed of the revolving magnetic field depends upon the frequency and the number of poles for which the motor is wound. It is entirely independent of the number of phases. The only condition which must be fulfilled in regard to the number of

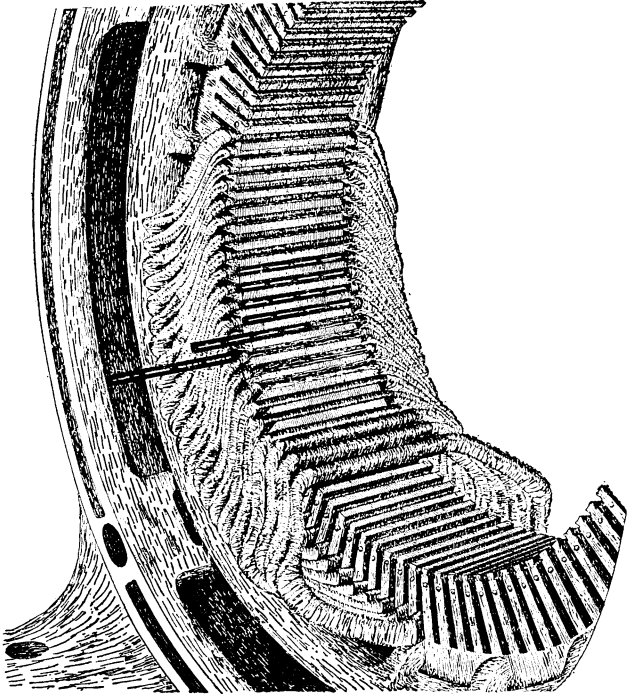

FIG. 212.

phases is, that the space relations of the windings for the different phases in electrical degrees must be the same as the time-phase relations between the currents they carry. Thus for a three-phase winding, they must be 120 electrical degrees apart. For a four-phase winding, they must be 90 electrical degrees apart.

Slip.—If f_1 and p are, respectively, the impressed frequency and the number of poles, the speed of the revolving magnetic

field and also the synchronous speed of the motor in revolutions per minute is

$$n_1 = \frac{2f_1}{p} 60 \quad (149)$$

The actual speed of the rotor will be less than this and is

$$n_2 = n_1(1 - s) \quad (150)$$

where s is the slip expressed as a fraction of synchronous speed.

Revolving Magnetic Field.—Assume the rotor to be on open circuit. This corresponds to the condition in a static transformer when the secondary is open. The only magnetomotive forces acting in this case are the magnetomotive forces produced by the primary windings.

The primary winding of an induction motor is distributed and is similar to the armature winding of an alternator having the same number of phases and poles.

At any instant, the space distribution of the flux caused by any one phase will be determined by the distribution of the winding. The air gap of an induction motor is uniform and, except for the presence of the slots, does not affect the flux distribution. The space distribution of the flux set up by the stator will be more nearly sinusoidal as the number of slots per phase is increased. This distribution may be found by the method indicated on page 84 in the section on Synchronous Generators. The time variation of the air-gap flux due to any one phase may or may not be sinusoidal depending upon the wave form of the impressed voltage. If the space distribution of the flux produced by each stator phase is sinusoidal, the fundamentals of the time variation of the air-gap flux for all phases combined will produce a revolving magnetic field revolving at synchronous speed, constant in value and sinusoidal in its space distribution.

The flux due to any one phase is oscillatory. As in the transformer, it induces a voltage which is equal to the voltage impressed on the phase less the impedance drop due to the resistance and leakage reactance of the primary winding. Except as this induced voltage is influenced by the impedance drop, it will be of the same wave form as the impressed voltage and the magnetizing current must adjust itself to meet this condition. If the impressed voltage is sinusoidal the induced voltage will be very

nearly sinusoidal, since the impedance drop is small. If the impressed voltage contains harmonics, the induced voltage will contain the same harmonics for the same reason.

Fig. 213 shows the developed stator of a three-phase induction motor. The dots represent inductors and the numbers indicate the phases to which the inductors belong.

The full line, the dotted line and the dot-and-dash line show, respectively, the fundamentals of the space distribution of the fluxes produced in the air gap by phases 1, 2 and 3 at the instant when the current in each phase has its maximum positive value.

Consider a point b , situated α electrical degrees from the beginning of phase 1. The flux density, \mathfrak{B}_b , at this point is

$$\mathfrak{B}_b = \mathfrak{B}_1 \sin \alpha + \mathfrak{B}_2 \sin (\alpha - 120) + \mathfrak{B}_3 \sin (\alpha - 240) \quad (151)$$

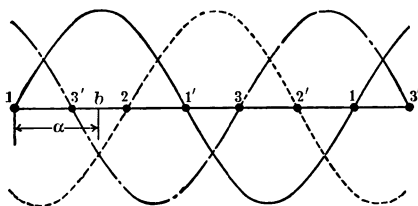

FIG. 213.

where \mathfrak{B}_1 , \mathfrak{B}_2 and \mathfrak{B}_3 are the flux densities at the centers of phases 1, 2 and 3, respectively, at the instant considered. If only the fundamental of the time variation of the flux is considered, equation (151), may be written

$$\begin{aligned} \mathfrak{B}_b &= \mathfrak{B}_m \{ \sin \alpha \sin \omega t + \sin (\alpha - 120) \sin (\omega t - 120) \\ &\quad + \sin (\alpha - 240) \sin (\omega t - 240) \} \\ &= \frac{3}{2} \mathfrak{B}_m \cos (\alpha - \omega t) \\ &= \frac{3}{2} \mathfrak{B}_m \sin (\omega t + \frac{\pi}{2} - \alpha) \end{aligned} \quad (152)$$

Equation (152) shows that the flux density at any point such as b is sinusoidal with respect to time. It also shows that at any given time, *i.e.*, for any fixed value of t , the space distribution of the air-gap flux is also sinusoidal.

If α , equation (152), equals ωt

$$\begin{aligned}\mathfrak{B}_b &= \frac{3}{2} \mathfrak{B}_m \sin \frac{\pi}{2} \\ &= \frac{3}{2} \mathfrak{B}_m\end{aligned}$$

or the magnetic field travels about the air gap at synchronous speed and has a constant value.

If w is the thickness of the stator core and A is the pole pitch in centimeters, the fluxes φ_1 , φ_2 and φ_3 through phases 1, 2 and 3, respectively, at any instant of time, t , are:

$$\begin{aligned}\varphi_1 &= \frac{3}{2} w \mathfrak{B}_m \frac{A}{\pi} \int_0^{\pi} \sin \left(\omega t + \frac{\pi}{2} - \alpha \right) d\alpha \\ &= 3 w \mathfrak{B}_m \frac{A}{\pi} \sin \omega t\end{aligned}\tag{153}$$

$$\begin{aligned}\varphi_2 &= \frac{3}{2} w \mathfrak{B}_m \frac{A}{\pi} \int_{120^\circ}^{\pi + 120^\circ} \sin \left(\omega t + \frac{\pi}{2} - \alpha \right) d\alpha \\ &= 3 w \mathfrak{B}_m \frac{A}{\pi} \sin \left(\omega t - 120^\circ \right)\end{aligned}\tag{154}$$

$$\begin{aligned}\varphi_3 &= \frac{3}{2} w \mathfrak{B}_m \frac{A}{\pi} \int_{240^\circ}^{\pi + 240^\circ} \sin \left(\omega t + \frac{\pi}{2} - \alpha \right) d\alpha \\ &= 3 w \mathfrak{B}_m \frac{A}{\pi} \sin \left(\omega t - 240^\circ \right)\end{aligned}\tag{155}$$

It may be seen from equations (153), (154) and (155) that the total flux through each phase is sinusoidal with respect to time and that the total fluxes linking the phases differ in time phase by 120 degrees.

Rotor Blocked.—The fundamental of the flux due to each phase induces a sinusoidal electromotive force in the rotor. If the rotor circuits are closed, polyphase currents will be induced in them of the same frequency as the primary currents provided the rotor is blocked. In this case the conditions are those of a short-circuited transformer. The currents in the rotor have the same frequency as the primary or stator currents and react on the stator in exactly the same way as the secondary current of a static transformer reacts on the primary. They cause an equivalent load-component current in the stator windings. This load-component current and the secondary current are opposite in phase and their ratio is equal to the ratio of the effective turns

per phase in the rotor windings to the effective turns per phase in the stator windings.

If N_1 and N_2 are the effective turns per phase in the stator and rotor windings, respectively, and I'_1 and I_2 the load component of the stator and rotor current, respectively,

$$\frac{I'_1}{I_2} = \frac{N_2}{N_1} = \frac{1}{a}$$

where a is the ratio of transformation.

The rotor current will lag behind E_2 , the induced voltage in the rotor winding, by an angle whose cosine equals $\frac{r_2}{\sqrt{r_2^2 + x_2^2}}$ where r_2 and x_2 are the rotor resistance and the rotor leakage reactance, per phase, at stator frequency. The vector diagram for a polyphase induction motor with rotor blocked is exactly the same as that for a short-circuited transformer. The magnetizing component of the stator current and the stator and the rotor reactances, x_1 and x_2 , are larger for the motor due to the air gap between stator and rotor windings.

The rotor current, considered with respect to the revolving magnetic field, produces a torque which acts in the direction of rotation of the magnetic field. If the rotor is free to revolve, it will speed up.

Rotor Free.—When the rotor is blocked, the speed of the stator field with respect to the rotor inductors is proportional to the primary frequency. When the rotor revolves, the speed of the stator field with respect to the rotor inductors is equal to the difference between the speed of the field in space and the rotor speed. This relative speed is

$$n_s = n_1 - n_2$$

where n_1 and n_2 are the speeds of the stator field and the rotor, respectively.

Replacing n_1 and n_2 by their values from equations (149) and (150), page 446,

$$n_s = \frac{2f_1}{p} 60s$$

The frequency of the rotor currents corresponding to the speed n_s is

$$f_s = f_1 s$$

The rotor currents at a frequency $f_1 s$ produce a rotating magnetomotive force in the rotor. This revolves at a speed

$$n_s = \frac{2f_1}{p} 60s$$

with respect to the rotor.

Since this magnetomotive force is revolving in the same direction as the rotor, its speed with respect to the stator is equal to its speed with respect to the rotor plus the speed of the rotor itself, or to

$$\begin{aligned} n_s + n_2 &= \frac{2f_1}{p} 60s + \frac{2f_1}{p} 60(1 - s) \\ &= \frac{2f_1}{p} 60 \end{aligned}$$

Its speed with respect to the stator is the same as the speed of the stator field in space. The frequency of the rotor current

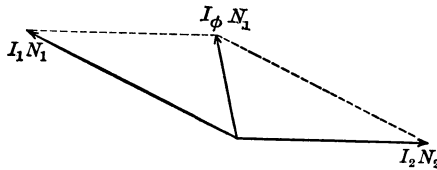

FIG. 214.

considered with respect to the stator current is the impressed frequency, f_1 , of the circuit. The rotor current, therefore, reacts on the stator current at this frequency whatever the speed of the rotor.

The resultant magnetomotive force causing the air-gap flux is equal to the vector sum of the magnetomotive forces of the stator and rotor currents. The condition is the same as in a static transformer. Fig. 214 shows the relation existing between these magnetomotive forces.

The letters on Fig. 214 have the following significance:

I_1 = Stator current.

I_2 = Rotor current.

N_1 = Number of effective turns per phase on the stator.

N_2 = Number of effective turns per phase on the rotor.

The flux, φ , corresponding to the magnetizing component, I_φ , of the stator current, I_1 , induces a voltage E_1 in the stator and a voltage E_2s in the rotor. E_2s has a frequency of f_1s with respect to the rotor but a frequency of f_1 with respect to the stator. The secondary current, I_2 , corresponding to the voltage E_2s is

$$I_2 = \frac{E_2s}{\sqrt{r_2^2 + x_2^2s^2}} \quad (156)$$

where x_2 is measured at primary frequency. At a frequency $f_2 = f_1s$, the secondary reactance is x_2s .

I_2 may be equally expressed by

$$I_2 = \frac{E_2}{\sqrt{\left(\frac{r_2}{s}\right)^2 + x_2^2}} \quad (157)$$

This form will be used later with the vector diagram. $E_2, \frac{r_2}{s}$ and x_2 in equation (157) are all referred to the stator and when so referred are at stator or impressed frequency. I_2 is also at stator frequency when so referred. The resistance, $\frac{r_2}{s}$, is the apparent resistance of the rotor when referred to the stator.

E_2 is the voltage which would be induced in the rotor by the flux φ if the rotor were blocked. It corresponds to the voltage induced in the secondary of a static transformer. E_2s is the actual voltage induced in the rotor when the rotor revolves with a slip of s . The difference, or $E_2(1 - s) = E_R$, may be considered to be the voltage induced in the rotor due to its speed n_2 . In other words $E_R = E_2(1 - s)$ is the rotational or armature voltage of the motor. E_R corresponds to the back electromotive force of a direct-current motor.

Load is Equivalent to a Non-inductive Resistance on a Transformer.—The internal power developed per phase by any motor is equal to the product of its current, rotational voltage and the cosine of the phase angle between them. The internal power developed by an induction motor is

$$P_2 = E_2(1 - s)I_2 \frac{r_2}{\sqrt{r_2^2 + x_2^2s^2}}$$

Replacing E_2 by its value from equation (156), page 451,

$$P_2 = I_2^2 r_2 \left(\frac{1-s}{s} \right) \quad (158)$$

Since $\frac{1-s}{s}$ is a numeric, $r_2 \left(\frac{1-s}{s} \right)$ may be considered as a fictitious resistance, R , which depends upon the slip or upon the mechanical load and

$$P_2 = I_2^2 R \quad (159)$$

The internal load of an induction motor is equivalent to a non-inductive load on a transformer. $I_2 R = V_2$ corresponds to the secondary terminal voltage of the equivalent transformer.

Transformer Diagram of a Polyphase Induction Motor.—The transformer diagram of a polyphase induction motor is shown in

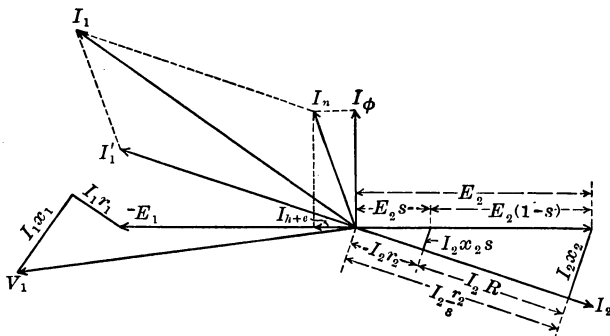

FIG. 215.

Fig. 215. Everything on this diagram is per phase and is referred to the stator.

The relative positions of the vectors on the secondary side of the diagram may be changed to correspond to their usual positions on the ordinary transformer diagram as indicated in Fig. 216.

$I_2 R$ corresponds to the potential difference, V_2 , at the secondary terminals of a transformer.

Equivalent Circuit of a Polyphase Induction Motor.—The conditions of the vector diagram are exactly those of the circuit shown in Fig. 217. This diagram shows what is known as the equivalent circuit of the induction motor. This circuit is in reality the

equivalent circuit of a transformer which supplies power to a non-inductive load, R . Everything in the equivalent circuit is referred to the primary or stator. For example, r_2 on Fig. 217 is the actual secondary resistance multiplied by the ratio of transformation squared where the ratio of transformation is obtained with the rotor blocked. The susceptance and conductance b_n and g_n are such that

$$I_n = E_1(g_n - jb_n)$$

With the ordinary transformer, little error is introduced into calculations based on the equivalent circuit if the portion of the circuit represented by b_n and g_n be placed directly across the impressed voltage. When this change is made in the equivalent diagram of an induction motor, the error introduced is much greater, since the exciting current, I_n , of an induction motor is large compared with the load component, I'_1 , of the stator current. The reactance, x_1 , of an induction motor is also much larger than the reactance of the primary winding of a transformer, chiefly on account of the air gap. The approximate equivalent circuit of the induction motor is given in Fig. 218. The

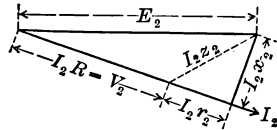

FIG. 216.

The reactance, x_1 , of an induction motor is also much larger than the reactance of the primary winding of a transformer, chiefly on account of the air gap. The approximate equivalent circuit of the induction motor is given in Fig. 218. The

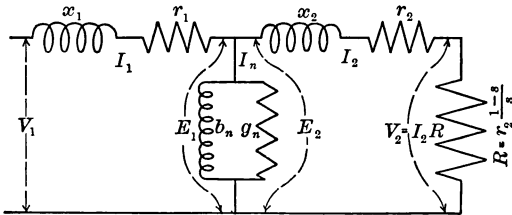

FIG. 217.

use of this circuit will generally introduce a nearly constant error of about 5 per cent. in the induced voltages E_1 and E_2 between no load and full load. The power and the torque corresponding to any given slip vary as the square of E_2 , and the error in these quantities introduced by the use of the approximate circuit may, therefore, be as high as 10 per cent.

Since everything on Fig. 218 is referred to the primary, $I'_1 = I_2$ and $I_1 = I_n + I_2$ vectorially.

The use of the true equivalent circuit for purposes of calculation can be considerably simplified by dividing the impedance drop in the primary into two components, one, produced by the exciting current, I_n , and the other, by the load component, I'_1 . Under ordinary conditions, the drop due to the exciting current will subtract almost directly from the impressed voltage. It may

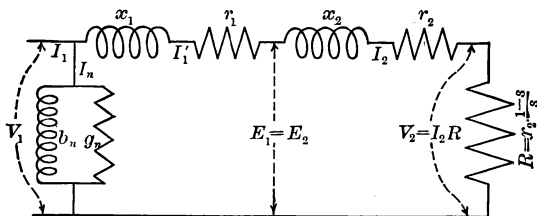

FIG. 218.

be assumed constant without introducing any great error in the value of the induced voltage, E_1 . According to this assumption

$$\begin{aligned} E_1 &= V_1 - I_n \sqrt{r_1^2 + x_1^2} - I'_1(r_1 + jx_1) \\ &= V'_1 - I'_1(r_1 + jx_1) \end{aligned}$$

where V'_1 is a constant voltage obtained by subtracting $I_n \sqrt{r_1^2 + x_1^2}$ directly from V_1 . The error in E_1 produced by this assumption ought not to exceed 2 per cent. from the condition of no load to that where the rotor is blocked.

Polyphase Induction Regulator.—Any polyphase induction motor with a coil-wound rotor, which is blocked so that it cannot turn under the influence of the torque developed by the motor, may be used as a polyphase transformer in which the time phase relation between the primary and secondary voltages of like phase may be changed progressively, by any desired amount, by merely moving the rotor into different positions with respect to the stator. Such a device is in common use in laboratories as a phase shifting transformer, but its chief use is as an induction regulator for controlling the voltage of polyphase lines. For the latter use it serves to add a voltage of fixed magnitude but of adjustable phase to each line of the system.

If the rotor of an induction motor with a coil wound rotor is blocked, with the centers of the rotor phase belts directly opposite the centres of corresponding stator phase belts, the maximum flux through the rotor and stator windings of like phases, due to the revolving magnetic field produced by the exciting currents in the stator windings, will occur at the same instant. Under this condition the primary and secondary induced voltages of like phases will be in time phase and the ratio of their magnitudes will be equal to the ratio of the numbers of effective primary and secondary turns per phase. The effective turns are equal to the actual turns multiplied by the pitch and breadth factors. If the rotor is turned through any angle, such as α electrical degrees, in the direction of rotation of the revolving magnetic field, the maximum value of flux linking any rotor winding will not change in magnitude but it will occur α time degrees later. The secondary induced voltages will be displaced by a like angle and will lag by an angle α behind the corresponding primary induced voltages. By changing the relative positions of the rotor and stator windings with respect to each other, any desired phase angle may be obtained between the voltages without altering their relative magnitudes.

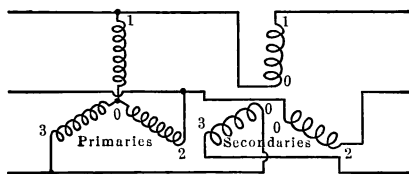

FIG. 218a.

The connections for a three-phase induction regulator are given in Fig. 218a. The primaries are shown connected in Y but they might equally well have been connected in delta.

The primaries are shunted across the line the voltage of which is to be regulated and one secondary is inserted in each line as shown.

The ratio of transformation of the main transformer feeding the circuit should be such as to maintain the desired voltage at the load at times of average load. When the load is greater than average the regulator would be set to increase the line

voltage and when less than average it would be set to decrease the line voltage. This permits the use of a regulator of minimum capacity. For a twenty per cent. variation of voltage, *i.e.*, from ten per cent. above to ten per cent. below the average, a regulator of only ten per cent. of the kilovolt-ampere capacity of the line would be required.

Vector diagrams for one phase are shown in Fig. 218*b*. From left to right these represent, respectively, the condition of no change in voltage, an increase in voltage (not maximum) and a decrease in voltage (not minimum). V_1 and V_2 are the line voltages to neutral on the primary and secondary sides of the regulator. V_R is the voltage added by the regulator.

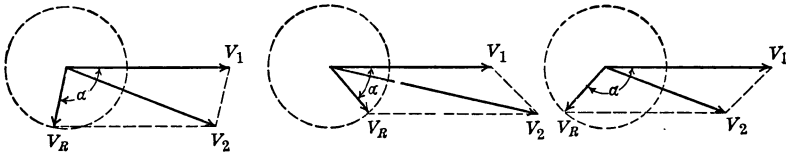
FIG. 218*b*.

The relative positions of the rotor and stator windings is controlled by means of a worm and gear with the gear mounted on the rotor shaft. This device not only makes it possible to turn the rotor to any desired position, but also serves to lock it so that it will not turn under the influence of the torque developed between the rotor and stator when their windings carry currents. The worm is usually mounted on the shaft of a small motor which is controlled either by hand or automatically. Some device must be provided to limit the movement of the rotor of the regulator to 180 degrees.

The difference between the action of the single-phase and the polyphase induction regulators should be noted. The single-phase regulator adds a variable voltage which is either in phase or 180 degrees out of phase with the line voltage. The polyphase regulator adds voltages which are fixed in magnitude but variable in phase.

CHAPTER XLIV

EFFECT OF HARMONICS IN THE SPACE DISTRIBUTION OF THE AIR-GAP FLUX

Effect of Harmonics in the Space Distribution of the Air-gap Flux.—Thus far only the fundamental of the space distribution of the flux due to each phase has been considered. The harmonics in the time variation of the air-gap flux were also neglected. This was equivalent to assuming that both the space distribution and the time variation of the air-gap flux were sinusoidal. The voltage induced by the air-gap flux in the primary winding must be equal at every instant to the primary impressed voltage minus the primary leakage impedance drop. The wave shape of the air-gap flux must adjust itself to meet this condition. It follows, that if the impressed voltage is sinusoidal, the time variation of the air-gap flux will also be sinusoidal except in so far as it may be slightly affected by the small resistance and leakage drops in the primary windings.

The space distribution of the flux cannot be exactly sinusoidal with any possible distribution of the primary winding, but it approaches this form as the number of slots per phase and the number of phases are increased. The presence of the stator and the rotor slots will introduce small harmonics into both the time variation and the space distribution of the air-gap flux but these will have relatively little effect.

For the present neglect all harmonics in the time variation of the air-gap flux. Under this condition, all of the harmonics in the space distribution of the flux, when considered with respect to any phase of the stator winding, have fundamental frequency with respect to time. They can, therefore, induce only electromotive forces of fundamental frequency in the stator winding.

The fundamental of the space distribution of the flux induces currents in the rotor which react to diminish the flux that produces them. In a similar way, the harmonics in the space

distribution of the flux induce currents in the rotor which also react to diminish the harmonics in the flux causing them. These currents will not be true harmonics of the rotor current, since the ratios of their frequencies to the frequency of the fundamental of the rotor current cannot, under ordinary conditions, be integers.

All the odd harmonics with some exceptions occur in the space distribution of the air-gap flux. In a three-phase winding, the third harmonic in the three phases cancel. In a six-phase winding, the third and fifth harmonics cancel. In general, the possible harmonics may be expressed by

$$\rho = 2xm \pm 1 \quad (160)$$

where ρ is the order of the harmonic, m the number of phases and x any integer.

In the case of a three-phase winding, the first harmonic which can occur is the fifth. The rotating field due to the fifth harmonic turns in the opposite direction to the field produced by the fundamental. The field due to the seventh harmonic turns in the same direction as that due to the fundamental.¹ In general, the fields caused by harmonics of the order

$$\rho = (2xm + 1)$$

turn in the same direction as the field due to the fundamental. The fields due to harmonics of the order

$$\rho = (2xm - 1)$$

turn in the opposite direction to the field due to the fundamental.

The speed of these fields is

$$n_\rho = \frac{n_1}{\rho} = \frac{n_1}{2xm \pm 1} \quad (161)$$

where $n_1 = \frac{(60)(2)f_1}{p}$ is the speed of the field produced by the fundamentals of the stator flux.²

¹ Section on Synchronous Generators, page 47.

² The number of poles produced by any harmonic in the space distribution of the flux is equal to the number of poles produced by the fundamental multiplied by the order of the harmonic. The frequency of the harmonic and fundamental are the same.

The harmonics in the stator field induce electromotive forces in the rotor. The frequencies of the electromotive forces corresponding to the harmonics of the order $(2xm + 1)$ are

$$f_{r,(2xm+1)} = \frac{(2xm+1)p}{2(60)} [n_{(2xm+1)} - n_2]^1$$

where $f_{r,(2xm+1)}$ is the frequency of the harmonic induced in the rotor by the $(2xm + 1)$ th harmonic of the primary field and n_2 is the actual rotor speed. $n_{(2xm+1)}$ is the speed with respect to the stator of the rotating field due to the $(2xm + 1)$ th harmonic.

Replacing $n_{(2xm+1)} = n_\rho$ by its value from equation (161) gives

$$f_{r,(2xm+1)} = \frac{p}{2} \frac{1}{60} [n_1 - (2xm + 1)n_2] \quad (162)$$

In a similar way, the harmonics of the order $(2xm - 1)$ induce electromotive forces in the rotor of frequencies

$$f_{r,(2xm-1)} = \frac{p}{2} \frac{1}{60} [n_1 + (2xm - 1)n_2] \quad (163)$$

These harmonics rotate in a direction which is opposite to that in which the rotor turns. Remembering that $\rho = (2xm \pm 1)$, equations (162) and (163) may be combined into a general equation which is

$$f_{r,(2xm \pm 1)} = f_{r,\rho} = \frac{p}{2} \frac{1}{60} (n_1 \mp \rho n_2) \quad (164)$$

The slip of the rotor with respect to any harmonic in the stator of the order ρ is

$$s_\rho = \frac{n_\rho \mp n_2}{n_\rho}$$

Replacing n_ρ by its value from equation (161) gives

$$s_\rho = \frac{n_1 \mp \rho n_2}{n_1} \quad (165)$$

Replacing n_2 in equation (165) by $n_1(1 - s)$, where s is the slip of the rotor with respect to the fundamental of the flux, gives

$$s_\rho = 1 \mp \rho(1 - s) \quad (166)$$

¹ $[n_{(2xm+1)} - n_2]$ is the slip and $(2xm + 1)p$ is the number of poles corresponding to the $(2xm + 1)$ th harmonic.

From equation (166), it is obvious that the slip of the rotor with respect to the fifth harmonic, which turns in the opposite direction to the fundamental in the case of a three-phase winding, is

$$\begin{aligned} s_5 &= 1 + 5(1 - s) \\ &= 6 - 5s \end{aligned}$$

If the rotor is driven at synchronous speed with respect to the fundamental of the stator field, s will be zero. Under this condition, the rotor slip will be six times the speed of the field due to the fifth harmonic.

The ratio of the frequency of the rotor electromotive force, $E_{2,\rho}$, caused by any harmonic of the order ρ to the frequency of the electromotive force induced in the rotor by the fundamental is (equation 164)

$$\frac{f_{r,\rho}}{f_{r,1}} = \frac{\frac{p}{2} \frac{1}{60} (n_1 \mp \rho n_2)}{f_{r,1}}$$

Replacing $(n_1 \mp \rho n_2)$ by its value from equation (165) and remembering that $\frac{p}{2} \frac{1}{60} n_1 = f_1$ and $f_{r,1} = s f_1$ gives

$$\frac{f_{r,\rho}}{f_{r,1}} = \frac{s_\rho f_1}{s f_1}$$

By substituting the value of s_ρ from equation (166) this becomes

$$\frac{f_{r,\rho}}{f_{r,1}} = \frac{1 \mp (1 - s)\rho}{s} \quad (167)$$

This ratio will be an integer only in exceptional cases. No simple relation exists between the frequencies of the currents induced in the rotor by the fundamental and the harmonics in the space distribution of the stator field, even when the time variation of the stator flux due to any phase is assumed sinusoidal. The rotor current, therefore, cannot be resolved into a fundamental and a series of harmonics and is not a periodic current in the ordinary understanding of the term.

If the time variation of the stator flux is not sinusoidal, the flux may be resolved into a fundamental and a series of harmonics. The effect of these harmonics in producing currents in the rotor will be similar to the effect of the harmonics in the space

distribution of the stator or air-gap flux. The harmonics in the time variation of the flux induce currents in the rotor, but the frequencies of these currents do not have integral relations among themselves and their relative phases will be continually changing. The relation between the frequencies of the currents caused by the harmonics and by the fundamental of the time variation of the flux are the same as given by equation (167). It is, therefore, useless to attempt to represent the secondary current by any definite curve since its wave form changes from instant to instant. If the wave form of the current in the rotor were obtained by a contact method, the instantaneous values of only that part due to the fundamental of the flux would be constant for any setting of the contact device, and alone would be recorded. The parts due to the harmonics would vary progressively from instant to instant, since the contact device would close the circuit at progressively different points on their waves. Their average over any reasonable length of time would, therefore, be zero.

Certain of the harmonics in the air-gap flux will tend to diminish slightly the torque developed by the motor. The air-gap flux caused by harmonics of the order $\rho = (2xm - 1)$ in the space distribution of the flux of each phase rotates in the opposite direction to the flux due to the fundamentals. The torque produced by these harmonics will be in the direction of their motion and will, consequently, oppose the main torque of the motor. In the case of a three-phase motor, the harmonics in the air-gap flux which can produce this diminution in torque are the 5th, 11th, 17th, etc. Due to the large slip and the high rotor reactance with respect to these harmonics, their effect on the torque developed by the motor will be small.

In what follows only the fundamental of the revolving field due to the stator windings will be considered.

CHAPTER XLV

ANALYSIS OF THE VECTOR DIAGRAM; INTERNAL TORQUE; MAXIMUM INTERNAL TORQUE AND THE SLIP CORRESPONDING THERETO; EFFECT OF REACTANCE, RESISTANCE, IMPRESSED VOLTAGE AND FREQUENCY ON THE BREAKDOWN TORQUE AND BREAKDOWN SLIP; SPEED-TORQUE CURVE; STABILITY; STARTING TORQUE; FRACTIONAL-PITCH WINDINGS; EFFECT OF SHAPE OF ROTOR SLOTS ON STARTING TORQUE AND SLIP

Analysis of the Vector Diagram.—Refer to the vector diagram of the induction motor, Fig. 215, page 452. The power input to the motor or the stator power per phase is

$$P_1 = V_1 I_1 \cos \theta_{I_1}^V \quad (168)$$

Resolving the impressed voltage, V_1 , into its components,

$$\begin{aligned} P_1 &= (\overline{E_1 + I_1 x_1 + I_1 r_1}) I_1 \cos \theta_{I_1}^V \\ &= E_1 I_1 \cos \theta_{I_1}^{E_1} + (I_1 x_1) I_1 \cos \frac{\pi}{2} + (I_1 r_1) I_1 \cos 0 \\ &= E_1 I_1 \cos \theta_{I_1}^{E_1} + 0 + \text{stator copper loss.} \end{aligned}$$

The expression for P_1 may be further expanded by replacing I_1 by its components.

$$\begin{aligned} P_1 &= E_1 (\overline{I'_1 + I_\varphi + I_{h+e}}) \cos \theta_{I_1}^{E_1} + 0 + \text{stator copper loss.} \\ &= E_1 I'_1 \cos \theta_{I'_1}^{E_1} + E_1 I_\varphi \cos \frac{\pi}{2} + E_1 I_{h+e} \cos 0 \\ &\quad + 0 + \text{stator copper loss.} \\ &= E_1 I'_1 \cos \theta_{I'_1}^{E_1} + 0 + \text{core loss} + 0 + \text{stator copper loss.} \end{aligned}$$

$E_1 I'_1 \cos \theta_{I'_1}^{E_1}$ is the power transferred across the air gap to the rotor by electromagnetic induction and is the total rotor power, P'_2 .

$$P'_2 = E_1 I'_1 \cos \theta_{I'_1}^{E_1} = E_2 I_2 \cos \theta_{I_2}^{E_2} \quad (169)$$

If E_2 is resolved into its components, the expression for P'_2 becomes

$$\begin{aligned} P'_2 &= \overline{[I_2 r_2 + I_2 x_2 s + E_2(1-s)]} I_2 \cos \theta_{I_2}^{E_2} \\ &= I_2^2 r_2 \cos 0 + I_2^2 x_2 s \cos \frac{\pi}{2} + E_2(1-s) I_2 \cos \theta_{I_2}^{E_2(1-s)} \\ &= \text{rotor copper loss} + 0 + \text{internal power.} \end{aligned}$$

The internal power, P_2 , developed in the rotor is, therefore,

$$P_2 = I_2 E_2 (1-s) \cos \theta_{I_2}^{E_2(1-s)} \quad (170)$$

Replacing I_2 and $\cos \theta_{I_2}^{E_2(1-s)}$ by $\frac{E_2 s}{\sqrt{r_2^2 + x_2^2 s^2}}$ and

$$\frac{r_2}{\sqrt{r_2^2 + x_2^2 s^2}}, \text{ respectively, gives}$$

$$P_2 = \frac{E_2^2 (1-s) s r_2}{r_2^2 + x_2^2 s^2} \quad (171)$$

For any fixed slip the internal power developed by a polyphase induction motor varies as the square of the voltage E_2 , *i.e.*, as the square of the voltage induced in the rotor by the air-gap flux. E_1 will not differ greatly from V_1 under ordinary conditions of operation, since $I_1 z_1$ is not large, although much larger than in the transformer. E_1 and E_2 are directly proportional, or E_2 is equal to E_1 when referred to the voltage, E_1 . E_2 is the voltage induced in the rotor when blocked by the same flux that induces E_1 and differs from E_1 only on account of the difference in the number of rotor and stator turns. E_2 referred to E_1 by multiplying it by the ratio of the effective number of stator to rotor turns will, therefore, be equal to E_1 . For a fixed slip, s , the internal power developed by a polyphase induction motor is approximately proportional to the square of the impressed voltage. It must be remembered that this statement holds only so long as the primary impedance drop is negligible with respect to the primary impressed voltage. It is strictly accurate only when the voltage induced by the air-gap flux is proportional to the impressed voltage, a condition which never occurs in practice.

Internal Torque.—The power developed by any motor is equal to its torque times the angular velocity of its rotor. Let T_2 be

the internal torque corresponding to the internal power P_2 . Then

$$P_2 = 2\pi n_2 T_2$$

Replacing n_2 by its value from equations (149) and (150), page 446, leaving out the 60 in equation (149) to get the speed in revolutions per second gives

$$P_2 = 2\pi \frac{2f_1}{p} (1 - s) T_2 \quad (172)$$

Hence

$$T_2 = \frac{p}{4\pi f_1} \frac{E_2^2 s r_2}{r_2^2 + x_2^2 s^2} \quad (173)$$

The voltage E_2 in equation (173) corresponds to the voltage induced in the secondary of a static transformer by the mutual flux. Although the E_2 of a transformer for most purposes may be assumed constant and independent of the load, the E_2 of an induction motor may not be so assumed. On account of the much larger leakage reactance of the induction motor, the induced voltage varies considerably from no load to full load. For this reason, E_2 in equation (173) should be replaced by the impressed voltage, V_1 , which is constant under ordinary operating conditions. An approximate value of V_1 in terms of E_2 may be obtained from the approximate equivalent circuit shown in Fig. 218, page 454.

From Fig. 218,

$$\begin{aligned} V_1 &= I_2 \left\{ (r_1 + jx_1) + \left(r_2 + r_2 \frac{1-s}{s} + jx_2 \right) \right\} \\ V_1 s &= I_2 \sqrt{(r_1 s + r_2)^2 + s^2 (x_1 + x_2)^2} \end{aligned} \quad (174)$$

From Fig. 215, page 452,

$$E_2 s = I_2 \sqrt{r_2^2 + x_2^2 s^2}$$

Therefore,

$$E_2^2 = V_1^2 \frac{r_2^2 + x_2^2 s^2}{(r_1 s + r_2)^2 + s^2 (x_1 + x_2)^2} \quad (175)$$

If E_2 from equation (175) is substituted in equation (173) the expression for internal torque becomes

$$T_2 = \frac{p V_1^2}{4\pi f_1} \frac{s r_2}{(r_1 s + r_2)^2 + s^2 (x_1 + x_2)^2} \quad (176)$$

$$T_2 = \frac{p}{4\pi f_1} I_2^2 \frac{r_2}{s}$$

The motor power may be obtained in terms of V_1 by combining equations (171) and (175).

$$P_2 = \frac{V_1^2(1-s)sr_2}{(r_1s + r_2)^2 + s^2(x_1 + x_2)^2} \quad (176a)$$

In terms of rotor current the motor power is

$$P_2 = I_2^2 r_2 \frac{1-s}{s}$$

Equation (175), giving the relation between E_2 and V_1 , neglects the effect of the exciting current, I_n , on the primary impedance drop. For a transformer, the effect of I_n on the primary impedance drop is negligible in most cases on account of the small magnitude of the exciting current of a transformer.

With an induction motor the conditions are different. For the motor the exciting current I_n is large, often as much as 35 to 40 per cent. of full-load current. The impedance of an induction motor is also larger than that of a transformer. For these reasons, the component I_n of the primary current of the motor cannot be neglected when finding the primary impedance drop without causing serious error.

Equations (176) and (176a) for torque and power and all subsequent equations derived from them involve equation (175) in which I_n is neglected. Since V_1 appears in these equations as a square any error produced in it by the neglect of I_n in equation (175) will be exaggerated.

In all equations for torque and power, V_1 should be understood to be the actual stator impressed voltage minus the part of the stator impedance drop caused by the component I_n of the stator current. No great error will be made by assuming $V_1 - I_n z_1$, vectorially, is equal to $V_1 - I_n z_1$, algebraically. (See page 454.) It is fully as accurate in most cases to assume $V_1 - I_n z_1$, vectorially, is equal to $V_1 - I_n x_1$, algebraically.

When calculating torque or power for normal operating conditions from any of the equations involving V_1 , V_1 should be replaced by $V_1' = V_1 - I_n x_1$ where the subtraction is made algebraically. Under these conditions I_n may be assumed constant and equal to no-load current at rated voltage.

If the resistances and reactances, and the voltage, V_1 , in equation (176) are expressed in absolute units, the torque will be in centimeter dynes.

Maximum Internal Torque and the Slip Corresponding Thereto.—For any fixed stator frequency, f_1 , and impressed voltage, V_1 , the torque will be a maximum when the second term of equation (176) is a maximum. Therefore, the slip at which the maximum torque occurs may be found as follows:

$$\frac{d}{ds} \left\{ \frac{sr_2}{(r_1s + r_2)^2 + s^2(x_1 + x_2)^2} \right\} = 0$$

$$s = \frac{r_2}{\sqrt{r_1^2 + (x_1 + x_2)^2}} \quad (177)$$

Substituting this value of s in equation (176) gives for the maximum torque

$$T_m = \frac{pV_1^2}{4\pi f_1} \frac{1}{2\{r_1 + \sqrt{r_1^2 + (x_1 + x_2)^2}\}} \quad (178)$$

From equations (177) and (178) it follows that the slip at which maximum internal torque occurs is directly proportional to the secondary or rotor resistance, and, that the maximum internal torque itself is independent of the rotor resistance. The effect of increasing the rotor resistance is to increase the slip at which maximum internal torque occurs without changing the value of that torque. Neither the maximum internal torque nor the slip at which it occurs is independent of the primary or stator resistance. Both are decreased by increasing the primary resistance.

The Effect of Reactance, Resistance, Impressed Voltage and Frequency on the Breakdown Torque and the Breakdown Slip.—The maximum torque which can be developed by an induction motor is its “breakdown” torque, *i.e.*, the torque at which it will become unstable with increasing slip.

The maximum torque and the slip at which that torque occurs depend upon the stator and rotor leakage reactances. Both decrease with increasing reactance, equations (177) and (178). It is, therefore, obviously impossible to have large breakdown torque associated with small slip. In order to have large breakdown torque, the leakage reactance of an induction motor must be small. Since the leakage reactance of an induction motor like

that of a transformer with an air gap between its primary and secondary windings increases with the length of the air gap, the necessity for small reactance requires the use of a small air gap. A large air gap not only decreases the maximum torque by increasing the leakage reactance but it also increases the reluctance of the magnetic circuit and increases the magnetizing current, thus lowering the power factor. Since the maximum torque developed by an induction motor varies as the square of the impressed voltage, equation (178), good voltage regulation is highly desirable on circuits from which induction motors are to be operated. Also, since both x_1 and x_2 are proportional to the primary frequency, f_1 , it is clear that induction motors are best suited for low frequencies. The effect of f_1 in the expression for maximum torque does not in itself show that the maximum torque of induction motors for different frequencies differ, since when compared on the only rational basis, namely the same speed, the ratio of p to f_1 , equation (178), would be constant. The reason high-frequency motors are less satisfactory than low-frequency motors is the effect of f_1 on the reactances, x_1 and x_2 .

Increasing the rotor resistance, r_2 , brings the maximum torque point toward 100 per cent. slip but does not affect the maximum value of the internal torque, equations (177) and (178). The external torque will be slightly decreased by an increase in r_2 on account of the increase in the rotor core loss with an increase in slip.

Speed-torque Curve.—The speed-torque curve of a polyphase induction motor may be plotted from equation (176). Four such curves are plotted in Fig. 219. These curves are plotted against slip instead of speed. •

Stability.—The internal torque is zero at synchronous speed. The working part of any speed-torque curve is from the point of maximum torque to synchronous speed. Synchronous speed cannot be quite reached even at no load, since no torque would be developed to balance the opposing torque caused by the rotational losses. If the load on a motor is increased to the point of maximum torque, the motor becomes unstable. Any further increase in slip produces a decrease in the torque and the motor breaks down and comes to rest. Between the points of synchronous speed and maximum torque, the motor is stable, since any in-

crease in slip due to an increase in load would then cause an increase in the torque developed. The ratio of the maximum torque to the full-load torque is largely a question of design. For most motors the ratio is two or even greater.

Starting Torque.—At starting, the slip is unity. Under this condition, equation (176), page 462, becomes

$$T_{st} = \frac{pV_1^2}{4\pi f_1} \frac{r_2}{(r_1 + r_2)^2 + (x_1 + x_2)^2} \quad (179)$$

T_{st} in equation (179) is the starting torque. Replacing V_1^2 by

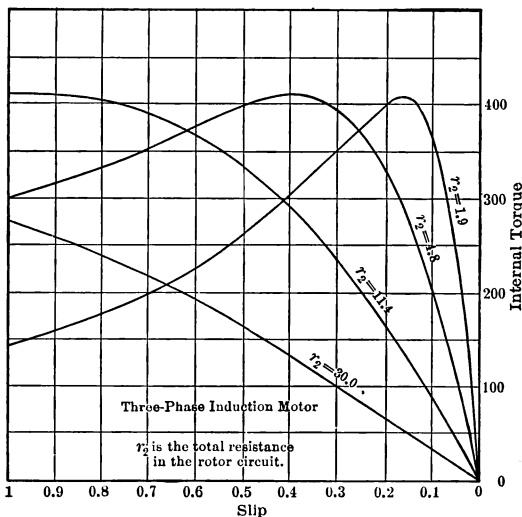

FIG. 219.

its value from equation (174), page 462, and remembering that $s = 1$ at starting gives

$$T_{st} = \frac{p}{4\pi f_1} I_2^2 r_2 \quad (180)$$

That is, the starting torque is proportional to the copper loss in the secondary or rotor circuit. This torque for any fixed impressed voltage may be increased up to a certain maximum value by increasing the resistance r_2 of the rotor circuit. It makes no difference whether the increase in resistance is obtained by actually increasing the rotor resistance or by putting external resist-

ance in series with the rotor windings. The starting torque will be a maximum when the constants of the motor are such as to make the slip unity in equation (177), page 463. From equation (177) for maximum torque at starting

$$r_2^2 = r_1^2 + (x_1 + x_2)^2 \quad (181)$$

By properly adjusting r_2 the maximum torque may be made to occur at starting, but for this value of resistance, the slip under normal running conditions will be large and the efficiency low. One curve on Fig. 219, page 465, is drawn for that value of r_2 which gives maximum torque at starting.

It will be seen from Fig. 219, that the portions of the speed-torque curves between maximum torque and synchronous speed are approximately straight lines. Therefore, when the maximum torque is made to occur at starting by increasing the rotor resistance, the slip at which full-load torque occurs is approximately equal to the ratio of full-load torque to maximum torque. Under this condition both the speed regulation and the efficiency are very poor.

For best running condition, r_2 should be as small as possible. For best starting torque, it should be large. In any motor, a compromise must be made between these two requirements. By proper design, it is possible to obtain good speed regulation with sufficiently satisfactory starting torque. When large starting torque is required, r_2 must temporarily be increased by inserting resistance in the rotor circuit. This resistance is cut out when the rotor is up to speed.

Fractional-pitch Windings.—In order to obtain good operating characteristics, it is desirable to make the reactance of induction motors low. (See equations 176, 178 and 179.) For this reason fractional-pitch windings are generally used for both the stator and rotor. Fractional pitch windings reduce the amount of copper required by shortening the end connections. They therefore reduce the resistance. They also reduce the reactance since some slots, in most fractional-pitch polyphase windings, contain coil sides which are not in the same phase. (See pages 81 and 148.) By decreasing the length of the end connections, fractional-pitch windings further diminish the reactance by decreasing the reactance of those connections.

Fractional-pitch windings distribute the turns in a greater number of slots per phase and thus produce a similar effect to using a greater number of slots per pole per phase. This gives a better space distribution of the air-gap flux and thus decreases the losses caused by the harmonics in that flux. By reducing the harmonics in the air-gap flux, fractional-pitch windings also reduce the reverse torque caused by the harmonics of reverse phase order, *i.e.*, of the order $\rho = (2xm - 1)$ where m is the number of phases and x is any integer. (See page 456.)

The decrease in the reactance increases the maximum torque and also increases the slip at which the maximum torque occurs. (Equations 177 and 178.) The change in the slip, however, is of minor importance compared with the change in the maximum torque. By decreasing the effective number of turns (effective number equals the actual number multiplied by the pitch and breadth factors), a fractional-pitch winding increases the magnetizing current and thus reduces the power factor for any given load. This decrease in the power factor might be avoided by using a few more turns, but this would increase the reactance and offset, in part at least, the reduction obtained by the use of the fractional-pitch winding.

Effect of Shape of Rotor Slots on Starting Torque and Slip.—

By proper shaping of the rotor slots and also of the inductors much can be accomplished in increasing the starting torque without sacrificing good speed regulation. If deep, narrow rotor slots with low-resistance inductors and end connections are used, the rotor resistance at standstill may be made several times greater than its resistance under normal running conditions.

The increase in the apparent resistance at standstill is due in part to the local losses set up by the slot leakage, but the chief cause of the increase is the tendency of the slot-leakage flux to force the current toward the top of the inductors. If the inductors are considered to be divided into horizontal elements similar to the elements, dx and dy , shown in Fig. 41, page 67, the linkages with these elements due to the slot leakage will increase in passing from the top to the bottom of an inductor, causing the leakage reactance of the lower elements to be higher than the leakage reactance of those above. As a result, the current will not be distributed uniformly over the

cross-section of the inductors but will be forced toward their upper portions producing an apparent increase in their resistance. The effect is the same as the ordinary skin effect of circular wires but is much more marked for the motor. The reactance of these elements, and consequently the apparent increase in the resistance, is dependent upon the frequency. At starting the frequency of the rotor current is f_1 . At any slip, s , it reduces to f_1s , and at full load it has from 2 to 10 per cent. of its starting value according to the size and type of the motor. Due to the decrease in the local losses and in the skin effect with decreasing frequency, the resistance of the rotor when running may be much less than at starting.

Low Power Factor of Low-speed Motors.—For fixed output, the torque of a motor varies inversely as the speed. For fixed frequency, the speed varies inversely as the number of poles. Therefore, for fixed output and frequency the torque per pole is constant.

The number of turns on the stator of an induction motor is determined, as in the case of a transformer, by

$$E = 4.44 \varphi_m f N 10^{-8}$$

where E is the voltage per phase induced in the stator winding (sensibly equal to the impressed voltage per phase) and φ_m is the total flux per pole. N is the effective number of turns per pole per phase multiplied by the number of poles. This assumes series connection.

Consider a specific case. Suppose a six-pole motor is already designed and it is desired to design another for the same output, frequency and voltage but for half speed. Assume that the flux density and axial width of the stator and rotor cores are to be kept the same for both motors. Also assume that the ampere conductors (product of current by conductors) per inch of rotor and stator periphery are to be kept constant. Then, for equal torque per pole, the second motor must have a pole face

$$\frac{1}{\sqrt{2}} = \frac{1}{1.41} = 0.707$$

times as great as that of the first motor. The flux per pole would also be 0.707 times as great, since the axial width of the cores and the flux density are not to be changed. With 0.707 times as much flux per pole, N would be 1.41 times as great as for the first motor, but there would be only

$$\frac{1.41}{2} = 0.707$$

times as many turns per pole.

For given stator power-current, the total peripheral force exerted on the rotor, which is proportional to the product of the ampere conductors on the rotor and the average flux density in the air gap, would be 1.41 times as great for the second motor as for the first. To get twice as many poles on the stator, with the pole arc decreased to

$$\frac{1}{1.41} = 0.707$$

its value for the first motor, would necessitate an increase in the diameter of both the stator and rotor of 0.41. The torque of the second motor, therefore, would be

$$\text{Force} \times \text{radius} = 1.41 \times 1.41 = 2$$

times as great as the torque of the first motor, which is what is required for an equal output at one-half speed.

The two motors were assumed to operate at the same flux density. If the air gaps are equal, the magnetizing currents will vary nearly inversely as the number of turns per pole. The magnetizing current of the second motor would therefore be about 1.41 times that of the first. The power factor of this motor would consequently be lower than that of the first.

Assume that the first motor operates at a power factor of 0.90 at full load. Its magnetizing current would then be approximately

$$\sin (\cos^{-1} 0.90) = 0.44$$

of full-load current. The power factor of the second or low-speed motor would be approximately

$$\cos \left(\tan^{-1} \frac{0.44 \times 1.41}{0.90} \right) = 0.82$$

For fixed output, flux density and frequency, the effect of decreasing the speed of an induction motor by designing it for greater number of poles is, in general, to increase the magnetizing current and hence to lower the power factor for any given load.

The design of a low-speed induction motor which will operate at a satisfactory power factor is difficult. In practice the number of turns used on the stator may have to be determined more by the question of permissible power factor than by the most desirable flux density.



CHAPTER XLVI

ROTORS, NUMBER OF ROTOR AND STATOR SLOTS, AIR GAP; COIL-WOUND ROTORS; SQUIRREL-CAGE ROTORS; ADVANTAGES AND DISADVANTAGES OF THE TWO TYPES OF ROTORS

Rotors, Number of Rotor and Stator Slots, Air Gap.—Two distinct types of rotors are used in induction motors, the coil-wound and the squirrel-cage. Each of these possesses certain distinct advantages. Both have slots which are usually partially closed. Very open slots are undesirable as they would materially increase the effective length of the air gap. This would increase the magnetizing current and hence decrease the power factor. On the other hand, completely closed slots are usually undesirable as they would decrease the reluctance of the path of the leakage flux and consequently increase the stator and rotor reactances thus decreasing the maximum torque developed by the motor. Magnetic wedges are sometimes used to hold the coils in the slots. Such wedges give the effect of closed or partially closed slots and decrease the effective length of the air gap. The stator shown in Fig. 212, page 445, has such wedges. Induction motors always have very short air gaps. For this reason, they should be provided with such bearings as will minimize the effect of wear and the danger of the rotor striking the stator.

The number of slots in the rotor and stator must not be the same. In order to prevent a periodic variation in the reluctance of the magnetic circuit of the motor the ratio of these numbers must not be an integer. Moreover, if the rotor and stator had the same number of slots, there would be a tendency for the rotor at starting to lock in the position which makes the reluctance of the magnetic circuit a minimum.

Coil-wound Rotors.—The windings of coil-wound rotors are similar to those of alternators. They must be arranged for the same number of poles as the stator, but the number of

phases need not be the same, although in practice it usually is so. Either mesh or star connection may be used, the rotors of three-phase motors being either Δ - or Y -connected. It is customary to use Y connection, not only for the rotor but also for the stator, as it gives a better slot factor than the Δ connection.¹ The terminals of the rotor winding are brought out to slip rings mounted on the shaft. These slip rings may be short-circuited for normal running conditions and connected through suitable resistances for starting or varying the speed. Since the current in the rotor is obtained entirely by induction, the operation of the motor is not influenced by the voltage for which the

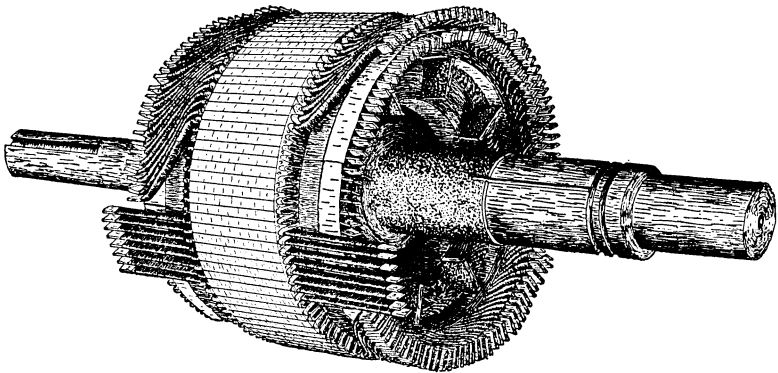

FIG. 220.

rotor is wound. The best voltage for a rotor is usually that which makes the cost of construction a minimum. A coil-wound rotor with a part of the winding in place but without the slip rings is shown in Fig. 220.

Squirrel-cage Rotors.—The windings of squirrel-cage rotors consist of solid copper inductors of either circular or rectangular cross-section, placed in the rotor slots with or without insulation and then short-circuited by copper end rings or straps to which the inductors are bolted, soldered or welded. Since low resistance is desirable, it is best to solder the short-circuiting end rings to the bars even if they are also bolted. The inductors of most squirrel-cage rotors are now electrically welded to the end rings. One type of squirrel-cage rotor is indicated in Fig. 221.

¹ Page 35, Synchronous Generators.

Advantages and Disadvantages of the Two Types of Rotor.
 —The chief advantage possessed by the coil-wound rotor is the possibility it offers of having its apparent resistance varied by inserting resistances between its slip rings. This variation in resistance may be used to increase the starting torque or to vary the speed. The chief disadvantages of this type of rotor are its higher cost, slightly higher resistance¹ and less ruggedness

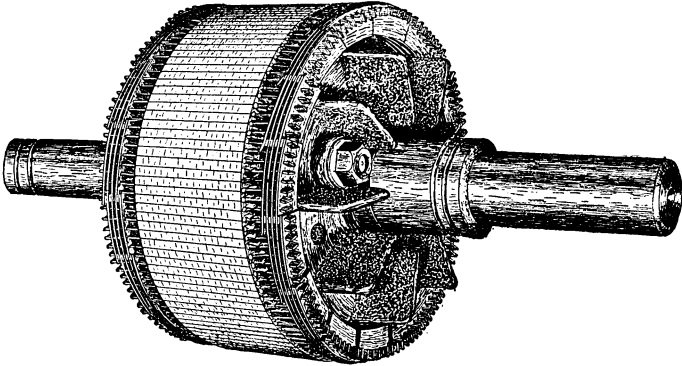

FIG. 221.

than the squirrel-cage type. Squirrel-cage rotors are extremely rugged and have very low resistances. Consequently, they develop low starting torque but have good speed regulation. The starting current taken by a motor having a squirrel-cage rotor is large and the power factor at starting is low.

¹ This resistance is referred to the primary. Its actual resistance is necessarily many times that of the squirrel-cage type.

CHAPTER XLVII

METHODS OF STARTING POLYPHASE INDUCTION MOTORS; METHODS OF VARYING THE SPEED OF POLYPHASE INDUCTION MOTORS; DIVISION OF POWER DEVELOPED BY MOTORS IN CONCATENATION; LOSSES IN MOTORS IN CONCATENATION

Methods of Starting Polyphase Induction Motors.—Referring to the equivalent circuit of the polyphase induction motor, Fig. 217, page 453, the stator current is

$$I_1 = I_n + I_2$$

where I_n and I_2 are considered as vectors. At starting, full voltage being applied and no resistance added to the rotor circuit, the current taken by an induction motor is from five to eight times the full-load current. If the stator and rotor constants are assumed to be approximately equal when referred to either the stator or rotor, the magnetizing current when the slip is unity will be only about half as large as it is when the motor is running under normal conditions, same impressed voltage being assumed. Consequently, the starting current taken by a motor which has no resistance added to its rotor circuit may be considered to be approximately equal to the secondary current referred to the primary. From Fig. 217, neglecting the divided circuit and making $s = 1$,

$$I_{st.} = V_1 \left\{ \frac{1}{\sqrt{(r_1 + r_2)^2 + (x_1 + x_2)^2}} \right\} \quad (182)$$

The approximate power factor corresponding to this is

$$p.f._{st.} = \frac{r_1 + r_2}{\sqrt{(r_1 + r_2)^2 + (x_1 + x_2)^2}} \quad (183)$$

The reactances are usually from three to four times the resistances. Therefore, the power factor at starting is low if no resistance be added to the rotor circuit. It must be remembered that equations (182) and (183) can be applied only when no resistance is added to the rotor circuit as under this condition alone is the magnetizing current negligible.

The starting torque, equation (180), page 465, has already been found to be

$$T_{st} = \frac{p}{4\pi f_1} I_2^2 r_2$$

The starting torque is, therefore, proportional to the copper loss in the rotor circuit. It may be increased to the maximum torque of the motor by increasing the resistance of the rotor circuit.

Small motors may be started by connecting them directly to the line, but when started in this way, they take a very large current at low power factor. The magnitude of the current taken by a motor larger than a few horsepower prevents the use of this method for starting large motors. It is seldom employed even in the case of small motors.

There are two methods for starting polyphase induction motors without taking excessive current from the line: by reducing the impressed voltage, by inserting resistance in the rotor circuit. Motors with squirrel-cage armatures must be started at reduced voltage. Motors with coil-wound armatures may be started by either reducing the voltage or by inserting resistance, although the latter is usually employed. There would be no object in using a coil-wound armature except for increasing the starting torque or for varying the speed.

The reduced voltage for starting is usually obtained by means of a compensator giving from one-half to one-third normal voltage. The motor is brought up to speed on this reduced voltage and then thrown on full line voltage. For starting motors with coil-wound armatures, drum-type controllers, similar to those employed for varying the speed of direct-current series motors, are generally used. The first position of the handle on these controllers puts the stator across full line voltage and closes the rotor circuit through resistance. Successive positions of the controller handle reduce the resistance and finally the rotor is short-circuited. The resistance units are usually of the grid type and are external to the controller. When this method of starting is employed, motors may be brought up to speed under any load which requires a torque not exceeding the maximum torque of the motor. The current required to develop a given torque when starting with

resistance in the rotor circuit is the same as that required to develop the same torque under running conditions. The torque per ampere is a characteristic constant of the induction motor when operating on the stable part of its speed-torque curve, *i.e.*, on the part between synchronous speed and maximum torque. If full-load torque is required, the current will be equal to the normal full-load current of the motor. Equation (176), page 462, for the torque may be written

$$T_2 = \frac{pV_1^2}{4\pi f_1} \frac{\frac{r_2}{s}}{\left(r_1 + \frac{r_2}{s}\right)^2 + (x_1 + x_2)^2} \quad (184)$$

From Fig. 218, page 454,

$$I_1 = V_1 \left\{ \left[g_n + \frac{r_1 + \frac{r_2}{s}}{\left(r_1 + \frac{r_2}{s}\right)^2 + (x_1 + x_2)^2} \right] - j \left[b_n + \frac{x_1 + x_2}{\left(r_1 + \frac{r_2}{s}\right)^2 + (x_1 + x_2)^2} \right] \right\} \quad (185)$$

$$= V_1(G - jB) \quad (186)$$

At starting, $s = 1$. Therefore, if r_2 plus the resistance, r'_2 , inserted in the rotor circuit at starting is made equal to r_2 divided by the slip at full load, both the torque developed by the motor and the current it takes will be the same as at full load. From equation (186) the approximate power factor is

$$p.f. = \frac{G}{\sqrt{G^2 + B^2}}$$

This will also be the same as at full load when $r_2 + r'_2$ is made equal to $\frac{r_2}{s}$ where s is the slip at full load.

If it is desired to have the motor develop its maximum torque at starting, r_2 must be made equal to $\sqrt{r_1^2 + (x_1 + x_2)^2}$, equation (181), page 466.

When resistance is inserted in the armature during starting only, it is sometimes placed inside the rotor and arranged to be cut out or in by means of a sliding rod passing through the

hollow shaft. The objection to this arrangement is the danger of over-heating the starting resistance either by leaving it in circuit too long or by trying to start the motor under too great a load.

Although much can be accomplished in increasing the starting torque of motors with squirrel-cage armatures by properly shaping the rotor slots and inductors, motors with coil-wound rotors and slip rings should be employed when high starting torque is desired. It is possible to design motors with squirrel-cage armatures which will give full-load torque at starting and will also have fairly satisfactory speed regulation. Such motors require several times the normal full-load current to develop this torque at starting since at starting, they are not on the part of the speed-torque curve where the torque per ampere is approximately constant.

Methods of Varying the Speed of Polyphase Induction Motors.—There are four ways by which the speed of a polyphase induction motor may be changed:

- (a) By inserting resistance in the rotor circuit.
- (b) By using a stator winding which can be connected for different numbers of poles.
- (c) By varying the frequency.
- (d) By concatenation or series connection for two or more motors.

(a) *By Resistance.*—This method of controlling the speed of an induction motor requires a coil-wound rotor with slip rings. Rotors are usually star-connected. For normal speed, the slip rings are short-circuited. During starting and also when the speed is to be reduced below normal speed, the slip rings are connected through suitable resistances. The slip of an induction motor may be found by

$$s = \frac{r_2}{r_1^2 + (x_1 + x_2)^2} \left\{ - \left[r_1 - \frac{K}{2T_2} \right] + \sqrt{\left[r_1 - \frac{K}{2T_2} \right]^2 - [r_1^2 + (x_1 + x_2)^2]} \right\} \quad (187)$$

where $K = \frac{pV_1^2}{4\pi f_1}$, equation (176), page 462.

For a given impressed voltage and frequency, K is a constant.

Therefore, for any fixed internal torque, T_2 , and constant impressed voltage and frequency, the slip of an induction motor varies directly as the rotor resistance, r_2 . Consequently, the speed of an induction motor may be varied by inserting resistance in its rotor circuit.

According to equation (169), page 460, the power transferred across the air gap to the rotor is

$$P'_2 = E_2 I_2 \cos \theta_{I_2}^{E_2}$$

But

$$I_2 = \frac{E_2 s}{\sqrt{r_2^2 + x_2^2 s^2}} \text{ and } \cos \theta_{I_2}^{E_2} = \frac{r_2}{\sqrt{r_2^2 + x_2^2 s^2}}$$

Hence

$$P'_2 = \frac{I_2^2 r_2}{s}$$

and

$$s = \frac{I_2^2 r_2}{P'_2} \quad (188)$$

The slip is equal to the ratio of the copper loss in the rotor circuit to the total power received by the rotor from the stator, or the loss of power in the rotor circuit is proportional to the slip. If the slip is 25 per cent., the electrical efficiency of the rotor is 75 per cent. If the slip is 50 per cent., the rotor efficiency is 50 per cent. If the slip is increased to 75 per cent., the efficiency is reduced to 25 per cent. The percentage decrease in the rotor efficiency is proportional to the slip.

Although the resistance method of controlling the speed is simple and often convenient, it is not economical and the drop in speed obtained by means of it is dependent upon the load. A motor, delivering full-load torque, which has its speed decreased to 50 per cent. of its synchronous speed by adding resistance to the rotor circuit, will speed up to nearly normal speed when the load is removed. The speed regulation of a motor, with resistance added to its rotor circuit, is poor.

It has already been shown that the maximum internal torque developed by a polyphase induction motor is independent of the resistance of the rotor circuit. Adding resistance changes the slip at which this maximum torque occurs and at the same time lowers the efficiency. Adding resistance to the rotor circuit

of a polyphase induction motor has much the same effect as adding resistance to the armature circuit of a direct-current shunt motor.

(b) *By Changing Poles.*—The speed of an induction motor is proportional to the frequency and inversely proportional to the number of poles for which the stator is wound. Therefore, if induction motors which operate at the same frequency are to run at different synchronous speeds, they must have different numbers of poles. Induction-motor windings may be arranged to be connected for two different numbers of poles which are in the ratio of 2:1. By the use of two independent windings four speeds may be obtained. Unless squirrel-cage rotors are used with such motors, the general arrangement of the rotor winding must be similar to that of the stator and its connections must be changed whenever the connections of the stator are changed in order that the rotor and stator shall have the same number of poles. On account of the additional slip rings and extra complication involved in arranging the rotor windings for pole changing, squirrel-cage rotors are generally used for multi-speed motors unless speeds are required intermediate to those obtained by changing the number of poles.

Multispeed induction motors are used to some extent on electric locomotives. The locomotives on some of the Italian State Railroads and on the Norfolk & Western Railroad in this country are of this type. Small multispeed motors for driving machine tools may be obtained in sizes up to 10 or 15 hp. from several companies manufacturing electrical machinery.

The difficulties in the design of a satisfactory multispeed motor are due to the change in the effective number of turns per phase, and consequently in the flux density, and to the change in the coil pitch when the connections are altered to change the number of poles. There are several practical ways to change the number of poles,¹ but all of these, if the voltage is kept constant, involve a change in the flux density and magnetizing current which may, in some cases, be as high as 100 per cent., and a change in the blocked current which is even greater. As a result the power and breakdown torque may be quite different for the two connections. The design of multispeed motors,

¹ Die Wechselstromtechnik, E. Arnold, Vol. III, Chap. VII.

consequently, must be more or less of a compromise between the designs which would give the best operating conditions at either speed.

In the practical design of two-speed induction motors, the speed ratio with a single winding is two to one. In these motors the coils are of such a width as to give full pitch for the connection producing the greater number of poles. Consequently, when connected for the smaller number of poles the pitch is one-half. The connections are so made that half of the poles are consequent poles when connected for the greater number of poles. The smaller number of poles is obtained by conducting the current to the center points of the windings of each phase. To keep the flux density somewhere nearly constant, a change may be made from delta to *Y* or from series to parallel connection. If, for example, for the larger number of poles, the connections are series delta and for the smaller number parallel *Y*, the flux densities will not be seriously different for the two speeds.

(c) *By Varying the Frequency.*—The speed of an induction motor is directly proportional to the frequency impressed on the stator. By varying this frequency, the speed may be changed. This method of varying the speed has the objection of requiring a separate generator for each motor, and for this reason it is applicable only in special cases.

Since an induction motor is in reality a transformer, the flux at any fixed voltage will vary inversely as the applied frequency. In order to prevent this change in flux density when the frequency is lowered with its attendant increase in core loss, magnetizing current and magnetic leakage, the voltage impressed on the motor must be varied in proportion to the frequency. This does not involve any difficulty, since the voltage of a generator varies in direct proportion to the frequency provided the excitation is kept constant. If the ratio of the frequency to the impressed voltage is kept constant, the torque at any given slip will vary in direct proportion to the voltage or the speed, equation (176), page 462.

(d) *By Concatenation.*—Concatenation, tandem or series connection for induction motors gives much the same effect as the series connection for direct-current series motors. In both cases, if the current taken from the mains is equal to the

full-load current of one motor, approximately twice the full-load torque of one motor at approximately one-half full-load speed results.

Motors which are to be connected in concatenation should have wound rotors and their ratios of transformation should preferably be unity. The rotors must be rigidly coupled. The stator of one motor is connected to the mains and its rotor is connected to the stator of the second motor. The rotor of the second motor is either short-circuited or connected through resistance. The resistance is used either during starting or when intermediate speeds are required.

If the ratios of transformation are not unity, the motors may still be operated in concatenation provided they have equal ratios of transformation. Then the rotors must be electrically as well as rigidly coupled. The primary of one must be connected to the mains and the primary of the other must be short-circuited.

Let p_1 and p_2 be the number of poles and let s_1 and s_2 be the slips for the two motors respectively. If f_1 is the frequency of the voltage impressed on the first motor, the frequency, f_2 , of the current in the primary of the second motor is

$$f_2 = f_1 s_1$$

Synchronous speed for motor No. 2 is, therefore,

$$\frac{2f_1 s_1}{p_2}$$

Its actual speed is

$$\frac{2f_1 s_1}{p_2} (1 - s_2)$$

The speed of motor No. 1 is

$$\frac{2f_1}{p_1} (1 - s_1)$$

Since both motors are rigidly coupled they must run at the same speed, hence

$$\frac{2f_1 s_1}{p_2} (1 - s_2) = \frac{2f_1}{p_1} (1 - s_1)$$

and

$$s_1 = \frac{p_2}{p_1 - s_2 p_1 + p_2}$$

As the rotor of the second motor is short-circuited, s_2 will be small. Therefore, the term $s_2 p_1$ may be neglected, giving

$$s_1 = \frac{p_2}{p_1 + p_2} \text{ approximately.} \quad (189)$$

The speed of the system is the same as the speed of the first motor or

$$\frac{2f_1}{p_1} (1 - s_1) = \frac{2f_1}{p_1} \left(1 - \frac{p_2}{p_1 + p_2}\right) = \frac{2f_1}{p_1} \frac{p_1}{p_1 + p_2} \quad (190)$$

If p_1 and p_2 are equal, the speed of the system will be equal to one-half of the normal speed of either motor. The use of two similar motors both in parallel and in concatenation, gives two efficient running speeds, viz., full speed with two motors in parallel, and half speed with the motors in concatenation. When the motors are in concatenation, other speeds may be obtained by the use of resistance in the rotor of the second motor. When the motors are in parallel, other speeds may be obtained by the use of resistance in both rotors. The use of two similar motors gives essentially a constant-torque system since approximately twice the full-load torque of one motor can be obtained at any speed and this without exceeding full-load current in either motor.

If motors having different numbers of poles are used, three different running speeds may be obtained, but in this case, two of these speeds make use of but one motor at a time. The full torque of the system is available only when the motors are in concatenation. The three speeds are obtained by the use of

- (a) Motor No. 1 alone.
- (b) Motor No. 2 alone.
- (c) Motors No. 1 and No. 2 in concatenation.

For example: let the motors have eight and twelve poles, respectively, and let the frequency be 25 cycles. Then, $p_1 = 8$, $p_2 = 12$ and $f_1 = 25$. The speeds obtainable in revolutions per minute are,

- (a) No. 1 alone

$$\text{speed} = \frac{2(25)}{8} 60 = 375 \text{ rev. per min.}$$

- (b) No. 2 alone

$$\text{speed} = \frac{2(25)}{12} 60 = 250 \text{ rev. per min.}$$

(c) No. 1 and No. 2 in concatenation.

With No. 1 connected to the mains

$$\text{speed} = \frac{2(25)}{8} 60 \left(\frac{8}{8 + 12} \right) = 150 \text{ rev. per min.}$$

With No. 2 connected to the mains

$$\text{speed} = \frac{2(25)}{12} 60 \left(\frac{12}{12 + 8} \right) = 150 \text{ rev. per min.}$$

In concatenation, it makes no difference so far as the speed of the system is concerned which motor is connected to the mains.

Division of Power Developed by Motors in Concatenation.—The complete expression for the division of the power developed by motors in concatenation is very complicated. When the magnetizing currents and the impedance drops are neglected, however, the expression becomes simple.

Neglecting the magnetizing current will produce considerable error yet expressions deduced under this assumption are of value, and may be considered as first approximations. If the magnetizing current of the second motor is neglected, the effect of this motor on the first is very nearly the same as if a non-inductive resistance were added to the rotor of the first motor. The actual effect of the second motor on the first is the same as adding an impedance to the rotor of the first motor. The ratio of the resistance of this impedance to the impedance itself is equal to the power factor of the second motor. This may be from 0.85 to 0.92 at full-load current. The effect of adding a non-inductive resistance to the rotor of an induction motor is to change the slip for a given current without altering the internal torque. The effect of adding impedance is to change not only the slip but the torque also.

Single and double primes added to the letters for voltage and current will refer to the first and second motor, respectively.

The mechanical power developed by the first motor is (equation 170, page 461).

$$E'_2 (1 - s_1) I'_2 \cos \theta_{I'_2}^{E'_2(1-s_1)}$$

That developed by the second is

$$E''_2 (1 - s_2) I''_2 \cos \theta_{I''_2}^{E''_2(1-s_2)}$$

Since the magnetizing currents and drops are neglected, the two currents, I'_2 and I''_2 , will be equal.

The two power factors, $\cos \theta_{I'_2}^{E'_2(1-s_1)}$ and $\cos \theta_{I''_2}^{E''_2(1-s_2)}$ will also be equal. Therefore,

$$\frac{\text{Power of No. 1}}{\text{Power of No. 2}} = \frac{E'_2(1-s_1)}{E''_2(1-s_2)}$$

The slip of an induction motor is equal to the ratio of the copper loss in the rotor circuit to the power received by the rotor from the stator. Since the drops are to be neglected, the copper loss in the rotor of the second motor will be zero. The slip, s_2 , of this motor is, therefore, zero. The second motor is connected to the rotor of the first. Since magnetizing currents and drops are neglected, its effect on that motor is like a non-inductive resistance. The slip, s_1 , of the first motor, therefore, cannot be zero.

$$\frac{\text{Power of No. 1}}{\text{Power of No. 2}} = \frac{E'_2(1-s_1)}{E''_2}$$

With the drops in the second motor neglected, $E''_2 = E'_2 s_1$. Therefore,

$$\frac{\text{Power of No. 1}}{\text{Power of No. 2}} = \frac{1-s_1}{s_1} \quad (191)$$

The slip of the system is $s_1 = \frac{p_2}{p_1 + p_2}$. Substituting this in equation (191) gives

$$\frac{\text{Power of No. 1}}{\text{Power of No. 2}} = \frac{1 - \frac{p_2}{p_1 + p_2}}{\frac{p_2}{p_1 + p_2}} = \frac{p_1}{p_2} \quad (192)$$

The division of power between the two motors is approximately proportional, therefore, to the ratio of the numbers of poles.

Since the first motor has line voltage and line frequency impressed on it, its flux is normal. The second motor receives a

voltage E'_{2s_1} at a frequency $f_2 = f_1 s_1$. Since the voltage and frequency impressed on the second motor are reduced in the same proportion, its flux is also normal. When the magnetizing currents are neglected, both rotors carry equal currents and at full-load current for the system each motor will develop its normal full-load torque. This assumes that the motors have equal ratings.

Losses in Motors in Concatenation.—*Motors with Equal Ratings and the Same Number of Poles. Conditions in the Motors.*

CURRENT.—The current in the first motor is normal. Neglecting the exciting current of the first motor, and assuming a ratio of transformation of unity, the current in the second motor is also normal.

VOLTAGE AND FREQUENCY.—The voltage and frequency impressed on the first motor are normal, but the second motor receives only half voltage at half frequency.

FLUX.—The flux of both motors is normal since the first receives normal voltage at normal frequency and the second receives half normal voltage at half normal frequency.

SPEED.—The speed of the motors is one-half normal speed.

TORQUE.—Since each motor has normal current (exciting currents are neglected) and normal flux, the torque of each will be normal.

COPPER LOSSES.—Each motor carries full-load current and will have normal full-load copper loss.

CORE LOSSES.—The core loss in the stator of motor No. 1 is normal. The core loss in the rotor of this motor is greater than normal on account of the large slip (50 per cent.).

The frequency and voltage impressed on motor No. 2 are each one-half normal. The flux is normal. This motor runs at normal speed, *i.e.*, with small slip, for the frequency which is impressed on it. The core loss in this motor will be less than normal on account of the low frequency.

POWER.—Each motor develops full-load torque at half speed. The output of each is, therefore, one-half its full-load output.

Motors with Equal Ratings and the Same Number of Poles. Conditions in the System.

POWER.—The power will be the full-load power of one motor. The first motor converts one-half the power it receives into mechanical work and transforms the other half into electrical

power at one-half normal voltage and one-half normal frequency. This electrical power is transformed into mechanical power by the second motor. This statement neglects the losses in the system.

TORQUE.—The torque will be twice the full-load torque of a single motor.

LOSSES.—The copper losses will be the full-load copper losses of both motors. The core losses will be somewhat less than the full-load core losses of both motors.

EFFICIENCY.—The efficiency will be less than the full-load efficiency of one motor. If the full-load efficiency of each motor under normal conditions is 90 per cent., the total losses will be approximately 20 per cent., the efficiency of the system will be approximately 80 per cent.

Motors with Different Numbers of Poles.

The conditions existing when the motors have different numbers of poles may be analyzed by following the method used for motors with the same number of poles.

It must not be forgotten that what has preceded in regard to conditions existing in motors when in concatenation has neglected an important factor, the magnetizing current, and cannot, therefore, be considered as more than an approximation to actual operating conditions.

CHAPTER XLVIII

CALCULATION OF THE PERFORMANCE OF AN INDUCTION MOTOR FROM ITS EQUIVALENT CIRCUIT; DETERMINATION OF THE CONSTANTS FOR THE EQUIVALENT CIRCUIT

Calculation of the Performance of an Induction Motor from Its Equivalent Circuit.—The equivalent circuit of the induction motor is again shown in Fig. 222.

The same notation will be used as in the vector diagram of Fig. 215, page 452.

$I_n = I_{h+e} + jI_\varphi$, the exciting current, is not the no-load current as in a transformer. The no-load current of an induction motor is equal to I_n plus a component which supplies the no-load copper and friction and windage losses. The letters g_n and b_n are

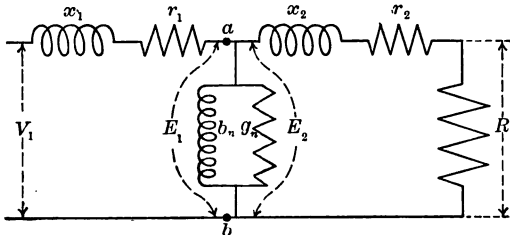

FIG. 222.

the conductance and the susceptance, which, at normal frequency, take, respectively, the currents I_{h+e} and I_φ at a voltage equal to E_1 . Everything will be referred to the stator and will be per phase unless otherwise stated.

$$I_n = I_{h+e} + jI_\varphi = E_1 (g_n - jb_n)$$

The apparent resistance of the rotor circuit, including the load, is

$$R + r_2 = r_2 \frac{1-s}{s} + r_2 = \frac{r_2}{s}$$

The apparent conductance, g_2 , of the rotor and load is

$$g_2 = \frac{\frac{r_2}{s}}{\left(\frac{r_2}{s}\right)^2 + x_2^2}$$

$$= \frac{r_2 s}{r_2^2 + x_2^2 s^2}$$

The apparent susceptance, b_2 , of the rotor and load is

$$b_2 = \frac{x_2}{\left(\frac{r_2}{s}\right)^2 + x_2^2}$$

$$= \frac{x_2 s^2}{r_2^2 + x_2^2 s^2}$$

The resultant conductance and susceptance, g_{ab} and b_{ab} , of the portion to the right of the points a and b of the equivalent circuit shown in Fig. 222 are

$$g_{ab} = g_n + g_2$$

$$b_{ab} = b_n + b_2$$

$$V_1 = E_1 + I_1(r_1 + jx_1)$$

$$I_1 = E_1(g_{ab} - jb_{ab}) \quad (193)$$

$$V_1 = E_1[1 + (g_{ab} - jb_{ab})(r_1 + jx_1)]$$

$$= E_1[1 + (g_{ab}r_1 + b_{ab}x_1) - j(b_{ab}r_1 - g_{ab}x_1)] \quad (194)$$

$$= E_1(G - jB) \quad (195)$$

Both G and B depend on the load.

From equation (195)

$$E_1 = \frac{V_1}{G - jB}$$

$$E_1 = \frac{V_1}{\sqrt{G^2 + B^2}} \text{ numerically.} \quad (196)$$

The power given to the rotor, or the synchronous power is

$$P'_2 = E_1^2 g_2 \quad (197)$$

This is the power which is transferred across the air gap

to the rotor and represents the internal power the motor would develop if it were to run at synchronous speed.

The actual internal power developed by the rotor at the speed $\frac{2f_1}{p}(1-s)$ is

$$P_2 = E_1^2 g_2 (1-s) \quad (198)$$

The power P_p developed at the pulley is

$$P_p = E_1^2 g_2 (1-s) - (\text{friction and windage loss}) \quad (199)$$

The torque at the pulley is

$$T_p = \frac{P_p}{2\pi \frac{2f_1}{p} (1-s)} \quad (200)$$

Assuming the friction and windage loss to be constant

$$T_p = \frac{E_1^2 g_2 - \frac{(\text{friction and windage loss})}{(1-s)}}{2\pi \frac{2f_1}{p}}$$

From equations (193) and (195), the stator input, P_1 , is

$$\begin{aligned} P_1 &= (E_1 G)(E_1 g_{ab}) + (E_1 B)(E_1 b_{ab}) \\ &= E_1^2 (Gg_{ab} + Bb_{ab}) \end{aligned} \quad (201)$$

The stator power factor is

$$p.f._1 = \frac{P_1}{I_1 V_1}$$

The efficiency is

$$\eta = \frac{P_p}{P_1}$$

All of the preceding equations are in c.g.s. units. If the quantities are expressed in practical units, the equations become
Stator phase voltage, V_1 , in volts

$$= E_1 \sqrt{G^2 + B^2} \quad (202)$$

Stator phase current, I_1 , in amperes

$$= E_1 \sqrt{g_{ab}^2 + b_{ab}^2} \quad (203)$$

Stator power, P_1 , per phase in watts

$$= E_1^2 (Gg_{ab} + Bb_{ab}) \quad (204)$$

Stator power factor

$$= \frac{E_1^2(Gg_{ab} + Bb_{ab})}{V_1 I_1} \quad (205)$$

Pulley output, P_p , per phase in horsepower

$$= \frac{1}{746} \{E_1^2 g_2 (1 - s) - (\text{friction and windage loss in watts})\}^1 \quad (206)$$

Torque at pulley, T_p , per phase in pound feet

$$= \frac{550}{2\pi} \frac{2f_1}{p} \left(\frac{1}{746}\right) \left\{E_1^2 g_2 - \frac{(\text{friction and windage loss in watts})}{1 - s}\right\} \quad (207)$$

Rotor phase current, I_2 , in amperes

$$= \frac{E_1 s}{\sqrt{r_2^2 + x_2^2 s^2}}$$

Slip in per cent.

$$= \frac{I_2^2 r_2}{P'_2} 100 = \frac{I_2^2 r_2}{E_1^2 g_2} 100 \quad (208)$$

where P'_2 is the power in watts per phase transferred across the air gap to the rotor.

If the constants of a motor are known, the performance may be calculated for any assumed slip from equations (202) to (208), inclusive.

Determination of the Constants for the Equivalent Circuit.—

Let P_n be the no-load input less friction and windage and primary copper losses. The rotor copper loss at no load may be neglected. P_n should be measured at a voltage E_1 , but a voltage equal to V_1 may be used without producing any great error. If necessary a correction may be made for the voltage, by assuming P_n to vary as the square of the voltage. Let I'_n be the total measured no-load current. Then

$$I_{h+c} = \frac{P_n}{V_1}$$

$$I_\varphi = I'_n \sqrt{1 - (\text{no-load power factor})^2}$$

$$g_n = \frac{I_{h+c}}{V_1}$$

and

$$b_n = \frac{I_\varphi}{V_1}$$

¹ The friction and windage loss should be measured at a speed corresponding to $(1 - s)$. It is, however, sufficiently accurate to measure it at the no-load speed and assume it to remain constant.

On account of the small slip of an induction motor under ordinary operating conditions, the frequency, $f_2 = f_1s$, of the current in the rotor is low. The effective and the ohmic resistances of the rotor will be nearly the same since the core loss due to the rotor leakage flux will be negligible on account of the low frequency. The ohmic resistance should be used for r_2 in the formula.

If the motor has a wound rotor, the ohmic resistance of its rotor may be measured directly. It must be referred to the primary as in a transformer before it can be used in the equations. Correction will usually have to be made for the stator impedance drop when finding the ratio of transformation. A correction must also be applied in case the rotor and stator windings are not of the same type, *i.e.*, both Δ or both Y . There is no satisfactory way of measuring the ohmic resistance of a squirrel-cage rotor. It is possible to calculate its value from the dimensions of the rotor but this is a complicated process.

The effective resistance should be used for the stator resistance, r_1 , since the core loss due to the stator leakage flux must be included on account of full frequency being impressed on the stator.

If the motor has a wound rotor and the ratio of the ohmic to the effective resistance is assumed to be the same for both stator and rotor windings, the effective resistance of the stator and of the rotor may be found by measuring the equivalent resistance of the whole motor at approximately full-load current with its rotor blocked and then dividing this resistance into two parts which are in the ratio of the stator and rotor ohmic resistances. The power input to the stator with blocked rotor is the total copper loss in the motor plus a core loss due to the rotating magnetic field of the stator. This core loss will not be large compared with the copper loss. It will be approximately equal to the input to the stator minus the stator copper loss¹ with the rotor blocked and on open circuit and with an impressed voltage equal to one-half the voltage used for the usual blocked run.

If P_b is the power input at frequency f_1 with the rotor blocked,

¹ This is a small correction and for this reason ohmic resistance may, if necessary, be used in computing it.

and V_b and I_b are the corresponding impressed voltage and stator current, the equivalent reactance of the entire motor at primary frequency is

$$x_e = \frac{V_b}{I_b} \sqrt{1 - (\text{blocked power factor})^2}$$

As there is no way of determining exactly how x_e divides between the rotor and stator, it is customary to assume it divides equally between them. This assumption is not correct in many cases but it does not affect the performance of the motor so far as torque and output are concerned, as may be seen by referring to equation (176), page 462. This same equation also shows that the effect of the rotor resistance is much greater than that of the stator. If only an approximate value of the primary resistance is used, little error will be introduced in the calculated torque and output.

When the rotor is blocked, the conditions are the same as in a short-circuited transformer except that a much greater voltage must be impressed to give any fixed percentage of full-load current in the motor on account of the presence of the air gap. The leakage reactances are also much higher for the motor. The no-load current of an induction motor is usually between 30 and 50 per cent. of the full-load current. The equivalent impedance drop at full-load current is usually between 15 and 20 per cent. of the rated voltage.

CHAPTER XLIX

CIRCLE DIAGRAM OF THE POLYPHASE INDUCTION MOTOR; SCALES; MAXIMUM POWER, POWER FACTOR AND TORQUE; DETERMINATION OF THE CIRCLE DIAGRAM

Circle Diagram of the Polyphase Induction Motor.—The circle diagram was first applied to the induction motor by Alexander Heyland in 1894.¹ Many modified forms of this diagram have since appeared. One of the simplest of these, in construction and use will be given. Although certain approximations are made in the construction of this diagram, the results obtained by it are, as a rule, quite satisfactory.

This diagram like all other circle diagrams of the polyphase induction motor, may be constructed from two sets of readings which may be obtained quickly and without the use of special apparatus. These readings are taken under conditions which correspond to those existing in a transformer on open circuit and on short-circuit, giving current, voltage and power with the motor operating at no load and again with blocked rotor. In addition the rotor or stator resistance is required.

Reference will be made to the approximate equivalent circuit shown in Fig. 218, page 454.

$$I_2 = \frac{V_1}{\sqrt{(r_1 + r_2 + R)^2 + (x_1 + x_2)^2}}$$

The sine of the angle of lag between I_2 and V_1 is

$$\sin \theta_2 = \frac{x_1 + x_2}{\sqrt{(r_1 + r_2 + R)^2 + (x_1 + x_2)^2}}$$

Hence,

$$I_2 = \frac{V_1}{x_1 + x_2} \sin \theta_2 \tag{209}$$

If x_1 and x_2 are assumed to be constant, this is the polar equation

¹Electrotechnische Zeitschrift, Vol. XLI, p. 561, 1894. A claim of earlier use is made by B. A. Behrend. See "The Induction Motor," B. A. Behrend, footnote, page 2.

of a circle with $\frac{V_1}{x_1 + x_2}$ as diameter. This circle is plotted in Fig. 223 with $AB = \frac{V_1}{(x_1 + x_2)}$ as diameter.

AI_2 is the rotor current to any suitable scale. To this same scale AB is the impressed voltage divided by the total motor reactance, *i.e.*, by $x_1 + x_2$, x_2 being referred to the stator. To obtain the stator current, I_1 , the current $I_n = I_{h+e} + jI_\varphi$ must be added to I_2 . Continue V_1A to D and draw OD perpendicular to AV_1 .

Make AD and OD equal to I_{h+e} and I_φ , respectively.

Let Oa be a line drawn parallel to AV_1 .

Then OA is the current I_n and OI_2 is the stator current. θ_1 is the stator power-factor angle.

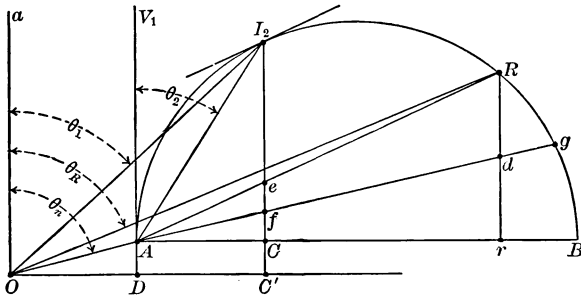

FIG. 223.

$I_2C' = I_1 \cos \theta_1$ and is the energy component of the stator current.

If V_1 is constant, I_2C' represents the input to the motor.

To the same scale AD represents the core loss.

The further construction of the diagram can be considerably simplified by making an approximation, which will have little effect on the results, except at small loads. In the equivalent circuit, Fig. 218, the branch marked g_n takes a current equal to I_{h+e} . The friction and windage losses are supplied by the secondary current I_2 . Let the current I_2 be decreased by an amount equal to the energy component of the current supplying the friction and windage losses, and let this amount be added to the current I_{h+e} to give I'_{h+e} , which is then the friction-and-windage

and core-loss current. Let I'_{h+e} also include the no-load primary copper loss. If these changes are made on the circle diagram shown in Fig. 223, AD to the proper scale becomes the core loss in the stator at no load, plus the no-load stator copper loss and the no-load friction and windage losses. OA will be the no-load current, I_2C will be the motor output plus the secondary copper loss and the increase in the primary copper loss caused by the load. As the motor is loaded, the true stator core loss will decrease slightly on account of a slight decrease in the value of E_2 . The decrease in E_2 with load is neglected in the approximate equivalent circuit. The rotor core loss will increase but this increase will be small and will tend to balance the decrease in the stator core loss. Little error is introduced by assuming the total core loss to remain constant and letting any increase in the rotor core loss as the motor is loaded be included in AD to balance the decrease in the stator core loss.

As the motor is loaded, I_2 will travel toward the point B on the circle and will reach some point, such as R , when the rotor has come to rest. This is the condition existing when the rotor is blocked under full voltage. Under this condition, OR is the primary current and, since the output is now zero, Rr must be the secondary copper loss plus the increase in the primary copper loss caused by the load.

Let d divide Rr into two parts such that Rd is the rotor copper loss and dr is the increase in the primary copper loss caused by the load. Join the points d and A . Then ef is the rotor copper loss and fC is the increase in the primary copper loss due to the current AI_2 . AI_2 represents the increase in the primary current caused by the load. It is also the secondary current.

Ce , ef and fC are, respectively, the total copper loss, the copper loss in the rotor and the increase in the copper loss in the stator produced by the load, *i.e.*, by the current AI_2 . This may be shown as follows:

$$\begin{aligned} \frac{Ce}{Rr} &= \frac{AC}{Ar} = \frac{AI_2 \cos BAI_2}{AR \cos BAR} \\ &= \frac{AI_2 \frac{AI_2}{AB}}{AR \frac{AR}{AB}} = \frac{(AI_2)^2}{(AR)^2} \end{aligned}$$

Since Ce and Rr are in the ratio of the square of the currents, AI_2 and AR , Ce must be the sum of the rotor copper loss and the increase in the stator copper loss produced by the load, or by the load current AI_2 . In a similar way, it may be shown that fC is the stator copper loss due to AI_2 . From this it follows that ef must be the rotor copper loss.

The slip of a motor is equal to the rotor copper loss divided by the power transferred across the air gap and is therefore

$$\frac{ef}{I_2f} \text{ See equation (208), page 487.}$$

The power given to the rotor is transferred at synchronous speed. This power divided by 2π times the synchronous speed is the torque at which the power is transferred. Since action and reaction between rotor and stator must be equal, this torque must also be the rotor torque. Therefore, since I_2f is the power given to the rotor less friction and windage losses, I_2f divided by 2π times the synchronous speed must be the pulley torque. The rotor losses affect only the speed and do not affect the torque at any given current.

The following quantities may now be obtained from the diagram by applying the proper scales.

Stator current	OI_2
Stator power	I_2C'
Stator power factor	$\cos \theta_1$
No-load current	OA
No-load losses	AD
No-load power factor	$\cos \theta_n$
Pulley output	I_2e
Power transferred across the air gap	I_2f

Torque is also proportional to

Slip	$I_2 f$
Efficiency	$\frac{ef}{I_2 f}$
	$\frac{I_2 e}{I_2 C'}$

Scales.—The current scale is arbitrarily assumed. The power scale in watts is the current scale multiplied by the voltage, *i.e.*, if the current scale is 5 amp. per inch and the phase voltage is 2200, the power scale is 11,000 watts per inch. The power scale in horsepower is equal to the watt scale divided by 746. The torque scale in pound feet is equal to the watt scale multiplied by $\frac{33,000}{746} \frac{1}{2\pi n}$, where n is the synchronous speed in revolutions per minute. The slip is given by the ratio of the lengths of two lines and hence does not involve a scale.

Maximum Power, Power Factor and Torque.—The maximum power will occur at that current which makes the distance $I_2 e$ on the diagram a maximum. To determine the maximum power it is necessary to draw a tangent to the circle parallel to the line AR . The point of tangency represents the position of the end of the primary current line, OI_2 , when the power is a maximum. The easiest way to determine the point of tangency is to erect a perpendicular bisector to the chord AR . The current OI_2 on Fig. 223 is drawn for the condition of maximum power. On Fig. 223, $I_2 e$ is the maximum power output. The maximum power factor will occur when the primary current line, OI_2 , becomes tangent to the circle. The maximum torque may be found by drawing a tangent to the circle parallel to the line Ad . The point of tangency in this case locates the extremity of the current line under the condition of maximum torque.

An inspection of the diagram will show that the motor will develop its maximum power output before it develops maximum torque. A properly designed motor under ordinary operating conditions should work on the part of the diagram considerably to the left of the extremity of the current line OI_2 for maximum

power shown on Fig. 223. The breakdown or maximum torque of a properly designed motor is seldom less than twice full-load torque.

Determination of the Circle Diagram.—The circle diagram is determined from two sets of measurements, one obtained with the rotor blocked and the other with the motor running at no load. The readings which are required under each of these conditions are: power input, current and impressed voltage, all under conditions of normal frequency. The no-load run should be made at rated voltage, but it is seldom safe to apply rated voltage to the motor when its rotor is blocked. Usually 40 to 60 per cent. of this voltage may be applied with safety. Under the blocked condition the current varies nearly as the impressed voltage. This assumption is used in finding the current the motor would take if blocked and with rated voltage impressed. The power taken when the rotor is blocked varies nearly as the square of the voltage. In addition to the readings already mentioned, either the ohmic resistance of the rotor or the effective resistance of the stator is necessary. If the motor has a wound rotor, it is an easy matter to measure the ohmic resistance of its stator and rotor. The rotor resistance as measured must be referred to the stator by multiplying it by the square of the ratio of transformation of the motor. The stator effective resistance may be obtained by multiplying its ohmic resistance by a suitable constant. This constant will depend upon the design of the machine.

To construct the diagram, choose a suitable scale for the currents. All the other scales depend upon this one. Take any line OC' , Fig. 223, as a base line and erect a perpendicular at O as a reference line from which to measure power factors. Everything on the diagram will be per phase. From O lay off the blocked current, OR , corrected to rated voltage, and the no-load current, OA , making angles θ_R and θ_n , respectively, with the voltage reference line Oa . Through A , draw a line AB parallel to OC' and drop a perpendicular, AD , from A to the base line. Both of the points A and R lie on the current circle. The diameter of this circle is on AB . A perpendicular erected at the middle point of a line connecting A and R will intersect the line AB at the center of the circle. Draw Rr perpendicular to AB and

locate the point d on this line by either making dr equal to the effective resistance loss caused by the current OR in the stator or by making Rd equal to the ohmic loss in the rotor due to the current AR in the rotor. Joining R and d with A completes the diagram. The conditions corresponding to any desired current or output or torque may then at once be found.

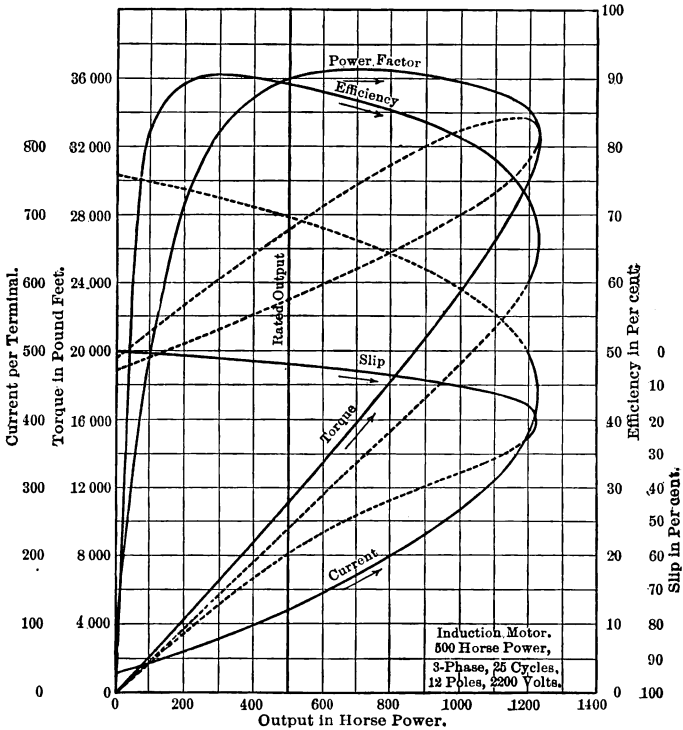

FIG. 224.

The complete characteristic curves of a three-phase, 25-cycle, 500-hp. induction motor calculated from a circle diagram are plotted in Fig. 224. The arrows on the curves indicate the direction the motor would pass over the curves in going from no load to the blocked condition. The portions of the curves beyond the point of maximum torque represent unstable conditions. These portions can, therefore, only be obtained by calculation.

CHAPTER L

GENERAL CHARACTERISTICS OF THE INDUCTION GENERATOR; CIRCLE DIAGRAM OF THE INDUCTION GENERATOR; CHANGES IN POWER PRODUCED BY A CHANGE IN SLIP; POWER FACTOR OF THE INDUCTION GENERATOR; PHASE RELATION BETWEEN ROTOR CURRENT REFERRED TO THE STATOR AND ROTOR INDUCED VOLTAGE, E_2 ; VECTOR DIAGRAM OF THE INDUCTION GENERATOR; VOLTAGE, MAGNETIZING CURRENT AND FUNCTION OF SYNCHRONOUS APPARATUS IN PARALLEL WITH AN INDUCTION GENERATOR; USE OF A CONDENSER INSTEAD OF A SYNCHRONOUS GENERATOR IN PARALLEL WITH AN INDUCTION GENERATOR; VOLTAGE, FREQUENCY AND LOAD OF THE INDUCTION GENERATOR; SHORT-CIRCUIT CURRENT OF THE INDUCTION GENERATOR; HUNTING OF THE INDUCTION GENERATOR; ADVANTAGES AND DISADVANTAGES OF THE INDUCTION GENERATOR; USE OF THE INDUCTION GENERATOR

General Characteristics of the Induction Generator.—An induction generator does not differ in its general construction from an induction motor. Whether an induction machine acts as generator or motor depends solely upon its slip. Below synchronous speed, it can operate only as motor, above synchronous speed it becomes a generator.

The power factor at which an induction generator operates is fixed by its slip and its constants, and not in any way by the load. The quadrature component of the current output is nearly constant for any fixed terminal voltage and frequency and always leads the voltage. The power factor of the induction generator is fixed by the machine and not by the load, and it is, therefore, necessary to operate such generators in parallel with synchronous machines. These synchronous machines serve not only to supply the quadrature lagging current demanded by the load, but in addition to supply sufficient quadrature lagging current to neutralize the quadrature leading component of

the current delivered by the induction generator. The induction generator depends upon its quadrature leading current for excitation and unless the combined connected load calls for this leading component, the induction generator will lose its excitation and hence its voltage. The synchronous machines which are in parallel with an induction generator determine its voltage and frequency. Its slip fixes its output.

Circle Diagram of the Induction Generator.—The circle diagram of Fig. 223, page 491 may be applied to the induction generator by merely completing the circle. All currents which lie below the base line OC' represent generator action.

Changes in Power Produced by a Change in Slip.—The following changes in power occur as the slip of an induction generator changes.

(a) At synchronous speed the rotor current is zero.¹ The current in the stator comes entirely from the synchronous machines, and is the exciting current, I_n , of the vector diagram of Fig. 215, page 452. The core losses are supplied by the synchronous generators. The mechanical power required to drive the rotor at synchronous speed is equal to the friction and windage losses.

(b) Below synchronous speed there is rotor current. To balance the demagnetizing action of this current there must be an equivalent component current in the stator circuit. Under this condition only motor power can be developed.

(c) Above synchronous speed the current in the rotor reverses in direction as will also the component current in the stator required to balance the demagnetizing action of this rotor current. At any speed above synchronism generator action exists, but power will not be delivered to the external circuit until the current in the stator, which balances the demagnetizing effect of the rotor current, has a component equal and opposite to the current, I_{h+e} , required to supply the core loss. At the slip at which this particular condition occurs, the generator supplies its own core loss. Its external output is zero. At larger slip, power will be delivered to the load.

¹ There may be harmonic currents in the rotor due to harmonics in the air-gap flux, but these harmonics and their effect will be small.

Power Factor of the Induction Generator.—The only current which can produce generator power in an induction generator is that component of the primary current which is equal and opposite to the rotor current. A 1:1 ratio of transformation between the rotor and stator is assumed. The power factor of this current with respect to the generated voltage is fixed by the rotor constants and the slip. It is given by

$$\cos \theta_{I_2}^{E_2} = \frac{r_2}{\sqrt{r_2^2 + x_2^2 s^2}}$$

Since the slip is small, $x_2^2 s^2$ is small compared with r_2^2 and $\cos \theta_{I_2}^{E_2}$ is nearly unity. The load component of the primary current, the I'_1 of the usual transformer diagram, is, therefore, nearly in phase with the primary induced voltage. Neglecting the magnetizing current and the phase displacement of the terminal voltage due to the resistance and reactance drops in the primary windings, the primary current will be very nearly in phase with the terminal voltage. This is the basis of the common but incorrect statement, that an induction generator can deliver power only at unity power factor. The magnetizing current is not negligible and the power factor in consequence of this may differ considerably from unity. The correct statement is that an induction generator can deliver power only at leading power factor. The power factor, in the case of large machines, usually is over 90 per cent. at full load, but at no load or small loads it may be quite low. The quadrature component of the current, mainly magnetizing, varies little with the load.

Phase Relation Between Rotor Current Referred to the Stator and Rotor Induced Voltage, E_2 .—The current in the rotor of an induction machine is always given by the following expression

$$I_2 = \frac{E_2 s}{r_2 + jx_2 s}$$

Rationalizing this by multiplying both the numerator and the denominator by $r_2 - jx_2 s$ gives

$$I_2 = E_2 \left\{ \frac{r_2 s}{r_2^2 + x_2^2 s^2} - j \frac{x_2 s^2}{r_2^2 + x_2^2 s^2} \right\} \quad (210)$$

Below synchronous speed s is positive and the expression for I_2

takes the form $I_2 = A - jB$ which represents a lagging current with respect to E_2s . Above synchronous speed the slip becomes negative and the real part of the expression (210) for the current reverses its sign while the sign of the imaginary part remains unchanged. Under this condition, the expression for the rotor current becomes $I_2 = -A - jB$. This represents a leading current with respect to E_2s which has reversed its sign with the change in the sign of the slip.

The current I_2 in the rotor cannot, of course, actually lead the voltage in the rotor which causes it, since the rotor circuit is inductive. It is only when this current is considered with respect to the stator that it has this apparent phase relation. The reason for the apparent change in phase is the reversal of the relative direction of motion of the revolving magnetic field and the rotor when the slip changes sign. This may be seen by referring to Fig. 225. Let the magnetic field move to the left, as is shown by the arrow.

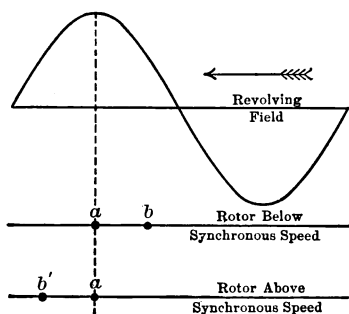

FIG. 225.

Consider the voltage induced in any inductor, a , on the rotor. This voltage will have its maximum value when the inductor is in the strongest part of the stator field, that is, in the position a , in Fig. 225.

Below synchronous speed the rotor moves to the right relatively to the field, and since the rotor circuit is inductive, the inductor will move to some position as b before the current in it reaches its maximum value. Above synchronous speed, the rotor moves faster than the field and will be moving to the left with respect to it. In this case the inductor a will move to some such position as b' before the current in it reaches its maximum value. In both cases the rotor when considered with respect to the stator moves in the same direction as the field, that is, from right to left. Therefore, if the electromotive force and current in the rotor are observed from any fixed point on the stator, the electromotive force will be seen to pass through its maximum value before the

current when the rotor is below synchronous speed and after the current when the rotor is above synchronous speed.

Vector Diagram of the Induction Generator.—The vector diagram of the induction generator is shown in Fig. 226.

I_1 is the total stator current and $\cos \theta_1$ is the stator power factor. It is the power factor which would be calculated from the readings of instruments placed in the mains leading from the generator. The angle θ_1 cannot under any conditions be an angle of lag. For fixed terminal voltage, V_1 , current, I_1 , and frequency f , there can be but one value of θ_1 and this an angle of lead. The induction generator, therefore, is a machine which has its power factor fixed by its constants and not by the power factor of the load.

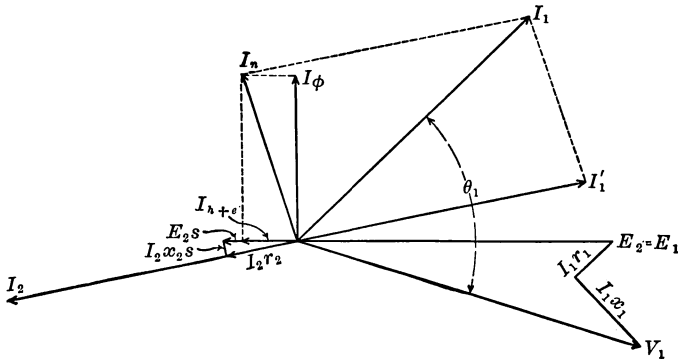

FIG. 226.

Voltage, Magnetizing Current and Function of Synchronous Apparatus in Parallel with an Induction Generator.—The voltage of the generator depends upon the magnetizing component, I_ϕ , of the primary current, I_1 , and unless the load calls for a component equal to this, the generator will lose its voltage. The function of the synchronous apparatus which must be operated in parallel with an induction generator is to absorb this current I_ϕ , or, more correctly stated, to adjust the power factor of the load on the induction generator to that at which it can deliver the required power.

With respect to the synchronous apparatus in parallel with the induction generator, the magnetizing current, I_ϕ , which

leads when referred to the terminal voltage of the induction generator, becomes a lagging current when referred to the terminal voltage of the synchronous apparatus. The synchronous apparatus must not only supply whatever lagging current is called for by the load but must also supply a lagging current equal to the leading magnetizing current of the induction generator. For this reason the use of induction generators is limited to systems which have inherently high power factor. The synchronous apparatus may be synchronous generators, synchronous motors, or rotary converters.

Use of a Condenser instead of a Synchronous Generator in Parallel with an Induction Generator.—It is possible to operate an induction generator without synchronous apparatus in parallel with it provided a suitable condenser is connected across its terminals, but this method of operation is of no practical importance on account of the size and cost of the condenser which would be required, as well as on account of the very drooping voltage characteristics of such a system. Moreover, the system would not be self-exciting and would, therefore, require an initial excitation from a synchronous generator.

Voltage, Frequency and Load of the Induction Generator.—

Case I.—In Parallel with a Synchronous Generator.—The voltage of the induction generator is equal to the voltage impressed across its terminals by the synchronous generator to which it is connected. The magnetizing current automatically adjusts itself to give this voltage. The frequency is determined by the frequency of the magnetizing current and is the same as the frequency of the synchronous generator. The load is fixed by the rotor current which depends on the slip.

Case II.—In Parallel with a Synchronous Motor or a Rotary Converter.—As in Case I, the voltage of the induction generator is determined by the terminal voltage of the synchronous motor or the converter. The initial excitation must come from a synchronous generator or from the synchronous motor or the converter driven as a generator. The frequency is fixed by the speed of the rotor and by the load. It is equal to

$$\frac{p}{2} \frac{n}{60(1-s)}$$

where p and n are, respectively, the number of poles and the

speed in revolutions per minute. It should be remembered that s is negative for generator action. The induction generator will carry the entire load and in addition will supply all the losses of the synchronous machine. The synchronous machine will supply sufficient quadrature current to adjust the power factor of the load on the system to that corresponding to the inherent power factor of the induction generator for that load. The slip is fixed by the load. The voltage regulation of the system is similar to the voltage regulation of a synchronous generator. The voltage at any given load is fixed by the constants of the induction machine, the excitation of the synchronous machine and the power factor of the circuit external to the induction machine.

Short-circuit Current of the Induction Generator.—Since an induction generator depends for its excitation upon the synchronous apparatus with which it is in parallel, the current it can supply on short-circuit depends upon the drop in voltage produced at the terminals of the synchronous apparatus by the short-circuit. On a short-circuit which drops the terminal voltage to zero, no current will be supplied by the induction generator. Very little current will be supplied on partial short-circuit since the maximum power an induction machine can deliver at any fixed slip and frequency is proportional to the square of its terminal voltage, equation (176), page 462. The inability to back up a short-circuit considerably reduces the resulting damage and permits the use of smaller and less expensive circuit-breakers than could safely be used if the whole capacity of the system were in synchronous generators.

Hunting of the Induction Generator.—An induction generator is free from hunting since it does not operate at synchronous speed. Any change in load must be accompanied by an actual change in speed instead of by a small angular displacement as with a synchronous generator. The irregularities in angular velocity of prime movers during a single revolution are so small as to produce only insignificant changes in load.

Advantages and Disadvantages of the Induction Generator.—Most of the advantages and disadvantages possessed by an induction generator are obvious from what has already been said. In a few words, the advantages are: the ruggedness of

the rotating part, its failure to back up a short-circuit, its freedom from hunting, the construction of its rotating parts makes it well suited to high speeds, it requires no synchronizing, its voltage and frequency are automatically controlled by the voltage and frequency of the synchronous machines which operate in parallel with it, it requires little attention.

Its disadvantages are: its fixed power factor and the consequent necessity to operate synchronous apparatus in parallel with it, the additional quadrature lagging current and reduced power factor at which the synchronous generators in parallel with it must operate.

Use of the Induction Generator.—The induction generator, on account of the leading component of the current it delivers, is suitable only for central stations operating at high power factor, such as those feeding substations containing synchronous apparatus. The induction generator is well suited for operation when driven by exhaust-steam turbines which receive steam from reciprocating engines directly connected to synchronous generators. In such cases the induction generator and its corresponding synchronous generator are connected together electrically as a unit and are brought up to speed together. No governor is required on the low-pressure steam turbine but it should be provided with some form of speed-limiting device.

Induction motors are sometimes made use of on locomotives which are to operate on heavy grades. Under such conditions, the induction generator action of the motors is used on down grades for the regeneration of power and electric braking.

CHAPTER LI

CALCULATION OF THE CONSTANTS OF A THREE-PHASE INDUCTION MOTOR FOR THE EQUIVALENT CIRCUIT; CALCULATION OF OUTPUT, TORQUE, INPUT, EFFICIENCY, STATOR CURRENT AND POWER FACTOR FOR A GIVEN SLIP FROM EQUIVALENT CIRCUIT AND ALSO FROM THE EQUATIONS FOR POWER, TORQUE AND THE VECTOR DIAGRAM.

Motor.—A 1000-hp., 2200-volt, three-phase, 25-cycle, 12-pole motor will be used. The motor is *Y*-connected and has a phase-wound rotor. Test data obtained from no-load and blocked runs and the measured stator and rotor resistances are given below.

Ohmic resistance at 25°C. of stator between terminals	=	0.130	ohm
Ohmic resistance at 25°C. of rotor between terminals	=	0.0772	ohm
At no load	}	{ Stator voltage between terminals = 2200 volts Stator current per terminal = 75.1 amp. Total input to stator = 15.2 kw.	
Temperature of windings 25°C.			
Rotor short-circuited			
With rotor blocked	}	{ Stator voltage between terminals = 2200 volts Stator current per terminal = 1960 amp. Total input to stator = 1960 kw.	
Temperature of windings 25°C.			
Rotor short-circuited			
With rotor blocked, at approximately full-load current	}	{ Stator voltage between terminals = 296 volts Stator current per terminal = 250 amp. Total input to stator = 38 kw.	
Temperature of windings 25°C.			
Rotor short-circuited			
Rotor on open circuit	}	{ Stator voltage between terminals = 2200 volts	
		{ Rotor voltage between terminals = 1500 volts	
Friction and windage loss at rated speed	=	3.1	kw.

Calculation of Constants for the Equivalent Circuit.—The equations given in Chap. XLVIII, page 484 will be used. All constants will be calculated per phase. A slip of 0.018 and a temperature of 75°C. will be assumed.

$$\text{Ratio of transformation} = \frac{2200}{1500} = 1.467$$

$$\text{Rated stator phase voltage} = \frac{2200}{\sqrt{3}} = 1270 \text{ volts.}$$

The equivalent resistance is

$$r_e = \frac{P_b}{I_b^2}$$

where P_b and I_b are the stator input per phase and the stator phase current, respectively, with blocked rotor. As the core loss due to the leakage flux which is included in P_b does not vary as the square of the current, r_e cannot be constant. For this reason, P_b should be for about full-load current.

The equivalent resistance per phase at 25°C. is

$$r_e = \frac{38 \times 1000}{3 \times (250)^2} = 0.203 \text{ ohm.}$$

The ohmic resistance of the rotor per phase at 25°C. referred to the stator is

$$r_2 = \frac{0.0772}{2} (1.467)^2 = 0.0831 \text{ ohm.}$$

If the effective resistances of the stator and rotor are assumed to be in the same ratio as the ohmic resistances, the effective resistances of the stator and rotor may be found by dividing the equivalent resistance of the motor into two parts which are proportional to the ohmic resistances of the stator and rotor.

The effective resistance of the stator per phase at 25°C. is

$$\begin{aligned} r_{e1} &= 0.203 \frac{0.065}{0.065 + 0.0831} \\ &= 0.089 \text{ ohm.} \end{aligned}$$

The ohmic resistance of the stator per phase at 75°C. is

$$\begin{aligned} r_1 &= 0.065 (1 + 50 \times 0.00385) \\ &= 0.0775 \text{ ohm.} \end{aligned}$$

The local core losses produced by the stator which are included in the effective resistance are not appreciably affected by the temperature. Therefore, the effective resistance of the stator at 75°C. is equal to its effective resistance at 25°C. minus its ohmic resistance at 25°C. plus its ohmic resistance at 75°C.

The effective resistance per phase of the stator at 75°C. is, therefore,

$$\begin{aligned} r_{e1} &= 0.089 - 0.065 + 0.0775 \\ &= 0.102 \text{ ohm.} \end{aligned}$$

The ohmic resistance of the rotor per phase at 75°C. referred to the stator is

$$\begin{aligned} r_2 &= 0.0831 (1 + 50 \times 0.00385) \\ &= 0.0992 \text{ ohm.} \end{aligned}$$

The no-load copper loss in the stator at 25°C. is

$$3(75.1)^2 0.089 \frac{1}{1000} = 1.5 \text{ kw.}$$

Neglecting the rotor copper loss, the no-load core loss is

$$P_n = 15.2 - 3.1 - 1.5 = 10.6 \text{ kw.}$$

where the 3.1 is the friction and windage loss.

This core loss is for a voltage equal to the rated terminal voltage instead of for a voltage equal to the full-load induced voltage, E_1 . The use of this value of the core loss will cause little error in the case of a motor as large as this.

$$I_{h+e} = \frac{P_n}{V_1}$$

where P_n is the core loss per phase.

$$I_{h+e} = \frac{\frac{1}{3}(10.6) \times 1000}{1270} = 2.78 \text{ amp. per phase.}$$

No-load power factor is

$$\frac{15.2 \times 1000}{\sqrt{3} \times 2200 \times 75.1} = 0.0531$$

$$I_\varphi = I'_n \sqrt{1 - (\text{no-load power factor})^2}$$

where I'_n is the no-load current of the motor at rated voltage with the rotor short-circuited.

$$\begin{aligned} I_\varphi &= 75.1 \sqrt{1 - (0.0531)^2} \\ &= 75.0 \text{ amp.} \\ g_n &= \frac{I_{h+e}}{V_1} \\ &= \frac{2.78}{1270} = 0.00219 \text{ mho per phase.} \\ b_n &= \frac{I_\varphi}{V_1} \\ &= \frac{75}{1270} = 0.0590 \text{ mho per phase.} \end{aligned}$$

The equivalent impedance per phase is equal to the ratio of the stator phase voltage to the stator phase current with the rotor blocked preferably at rated voltage.

$$x_e = \frac{V_b}{I_b} \sqrt{1 - (\text{blocked power factor})^2}$$

The blocked power factor at rated voltage is

$$\begin{aligned} p.f._b &= \frac{1960 \times 1000}{\sqrt{3} \times 1960 \times 2200} = 0.262 \\ x_e &= \frac{1270}{1960} \sqrt{1 - (0.262)^2} \\ &= 0.625 \text{ ohm.} \end{aligned}$$

Assuming $x_1 = x_2$ when x_2 is referred to the stator

$$x_1 = x_2 = \frac{x_e}{2} = 0.313 \text{ ohm.}$$

For the assumed slip of 0.018

$$\begin{aligned} g_2 &= \frac{r_2 s}{r_2^2 + x_2^2 s^2} \\ &= \frac{0.0992 \times 0.018}{(0.0992)^2 + (0.313)^2 (0.018)^2} \\ &= 0.1809 \text{ mho.} \end{aligned}$$

$$\begin{aligned}
 b_2 &= \frac{x_2 s^2}{r_2^2 + x_2^2 s^2} \\
 &= \frac{0.313 \times (0.018)^2}{(0.0992)^2 + (0.313)^2 (0.018)^2} \\
 &= 0.0103 \text{ mho.}
 \end{aligned}$$

The constants just calculated are brought together in the following table. Everything in this table is referred to the stator and is per phase. All resistances, susceptances and admittances are for 75°C.

$$\begin{aligned}
 V_1 &= 1270 \text{ volts} \\
 I_{h+e} &= 2.78 \text{ amp.} \\
 I_\varphi &= 75.0 \text{ amp.} \\
 g_n &= 0.00219 \text{ mho} \\
 b_n &= 0.0590 \text{ mho} \\
 r_{e1}(\text{effective}) &= 0.102 \text{ ohm} \\
 r_2(\text{ohmic}) &= 0.0992 \text{ ohm} \\
 x_1 &= 0.313 \text{ ohm} \\
 x_2 &= 0.313 \text{ ohm}
 \end{aligned}$$

$$g_2 = 0.1809 \text{ mho for a slip of } 0.018$$

$$b_2 = 0.0103 \text{ mho for a slip of } 0.018$$

$$g_{ab} = g_n + g_2 = 0.183 \text{ mho for a slip of } 0.018$$

$$b_{ab} = b_n + b_2 = 0.0693 \text{ mho for a slip of } 0.018$$

Output.—

$$E_1 = \frac{V_1}{\sqrt{G^2 + B^2}}$$

Where

$$\begin{aligned}
 G &= 1 + g_{ab} r_1 + b_{ab} x_1 \\
 &= 1 + 0.183 \times 0.102 + 0.0693 \times 0.313 = 1.040
 \end{aligned}$$

$$\begin{aligned}
 B &= b_{ab} r_1 - g_{ab} x_1 \\
 &= 0.0693 \times 0.102 - 0.183 \times 0.313 = -0.050
 \end{aligned}$$

$$E_1 = \frac{1270}{\sqrt{(1.040)^2 + (0.050)^2}}$$

$$= 1219 \text{ volts.}$$

Output of motor = $3P_i = 3E_1^2 g_2 (1 - s) - (\text{friction} + \text{windage loss})$

$$\begin{aligned}
 3P_p &= \frac{3(1219)^2 \times 0.982 \times 0.1809}{1000} - 3.1 \\
 &= 787 \text{ kw.} \\
 &= \frac{787}{746} \times 1000 = 1055 \text{ hp.}
 \end{aligned}$$

Torque.—The torque of the motor is

$$T = \frac{3P_p}{2\pi \frac{2f_1}{p}(1-s)}$$

To express the torque in pound feet, P_p must be expressed in foot-pounds per second.

$$\begin{aligned}
 T &= \frac{1055 \times 550}{2\pi \frac{2 \times 25}{12}(1-0.018)} \\
 &= 22,550 \text{ pound feet.}
 \end{aligned}$$

Input.—The input to the stator per phase is

$$\begin{aligned}
 P_1 &= E_1^2(Gg_{ab} + Bb_{ab}) \\
 &= (1219)^2(1.040 \times 0.1831 - 0.050 \times 0.0693) \\
 &= 277.8 \text{ kw.}
 \end{aligned}$$

P_1 for the whole motor = $3 \times 277.8 = 833.4$ kw. .

The values of G and B were found in calculating E_1 .

Efficiency.—The efficiency of the motor is

$$= \frac{\text{Output}}{\text{Input}} = \frac{787}{833.4} 100 = 94.4 \text{ per cent.}$$

Stator Phase Current.—The stator phase current is

$$\begin{aligned}
 I_1 &= E_1(g_{ab} - jb_{ab}) \\
 &= 1219\sqrt{(0.1831)^2 + (0.0693)^2} \\
 &= 238.9 \text{ amp.}
 \end{aligned}$$

Power Factor.—The stator power factor is

$$\frac{P_1}{I_1 V_1} = \frac{277.8}{1270 \times 238.9} 100 = 91.6 \text{ per cent.}$$

Example of the Calculation of the Performance of an Induction Motor from the Equations for Power, Torque, etc., and the Vector Diagram.—To apply the equivalent-circuit method of calculating the performance of an induction motor the slip must be either known or assumed. There is no such limitation when the performance is calculated from the equations and the vector diagram. If the slip is unknown, it is merely necessary to solve a quadratic equation for slip. (Equations 176 and 176*a*, pages 462 and 463.) Two values of the slip will be obtained. The smaller will correspond to stable operating conditions and will lie on the slip-torque curve (Fig. 219, page 466) between the point of zero slip and maximum torque. The other will lie on the portion of the curve which represents unstable conditions, *i.e.*, beyond the point of maximum torque. The solution of either equation 176 or 176*a* will involve taking the difference of squared quantities which will not differ greatly in magnitude. Since any error in either of the quantities subtracted will be exaggerated in their difference, some method of making the computations which will give more accurate results than a slide rule must be used in solving for slip.

From page 509, the phase voltage, currents, resistances and reactances of the 1000 hp. motor described on page 505 are:

$$\begin{aligned} V_1 &= 1270 \text{ volts per phase.} \\ I_{h+e} &= 2.78 \text{ amp. per phase.} \\ I_\phi &= 75.0 \text{ amp. per phase.} \\ r_{e1} \text{ effective} &= 0.102 \text{ ohm at } 75^\circ\text{C.} \\ r_2 \text{ ohmic} &= 0.0992 \text{ ohm at } 75^\circ\text{C.} \\ x_1 &= 0.313 \text{ ohm.} \\ x_2 &= 0.313 \text{ ohm.} \\ x_e = x_1 + x_2 &= 0.626 \text{ ohm.} \end{aligned}$$

All values are referred to the stator.

In order to be able to compare the results obtained from the equations and vector diagram with those derived from the equivalent circuit (see pages 506 to 510) the computations will be made for a slip of 0.018.

From page 463

$$\begin{aligned} V' &= V - I_n x_1 \text{ algebraically (approximately)} \\ &= 1270 - 75.1 \times 0.313 \\ &= 1246 \text{ volts.} \end{aligned}$$

From equation 176a, page 463

$$P_2 = \frac{V^2(1-s)sr_2}{(r_1s + r_2)^2 + s^2(x_1 + x_2)^2}$$

in which V' will be used for V (see page 463)

$$(r_1s + r_2)^2 = (0.102 \times 0.018 + 0.0992)^2 \\ = 0.01020$$

$$s^2(x_1 + x_2)^2 = (0.018 \times 0.626)^2 \\ = 0.000127$$

$$P_2 = \frac{(1246)^2(1 - 0.018)0.018 \times 0.0992}{0.01020 + 0.000127} \\ = 263,500 \text{ watts}$$

$$P_p = 3P_2 - (\text{friction} + \text{windage loss}) \\ = 3 \times 263.5 - 3.1 = 787.4 \text{ kw.}$$

$$= 787.4 \times \frac{1000}{746} = 1055 \text{ hp.}$$

From equation 174, page 462

$$I_2 = \frac{V'_{1s}}{\sqrt{(r_1s + r_2)^2 + s^2(x_1 + x_2)^2}} \\ = \frac{1246 \times 0.018}{\sqrt{0.01033}} \\ = 220.4 \text{ amp.}$$

Refer to the vector diagram on page 452. Using E_2 as an axis of reference:

$$I_1 = -I_2 \left\{ \frac{r_2}{\sqrt{r_2^2 + x_2^2s^2}} - j \frac{x_2s}{\sqrt{r_2^2 + x_2^2s^2}} \right\} - I_{h+c} + jI_\phi \\ = -220.4 \left\{ \frac{0.0992}{\sqrt{(0.0992)^2 + (0.313 \times 0.018)^2}} \right. \\ \left. - j \frac{0.313 \times 0.018}{\sqrt{(0.0992)^2 + (0.313 \times 0.018)^2}} \right\} \\ = -221.9 + j87.5 \\ = \sqrt{(221.9)^2 + (87.5)^2} \\ = 238.9 \text{ amp.}$$

Primary copper loss	$= 3 \times (238.9)^2 \times 0.102$	$= 17,460$ watts
Secondary copper loss	$= 3 \times (220.4)^2 \times 0.0992$	$= 14,460$ watts
Core loss		$= 10,560$ watts
Friction and windage loss		$= 3,100$ watts
		$= 45,580$ watts
Total losses		$= 45,580$ watts

$$\begin{aligned} \text{Efficiency} &= \frac{\text{Output}}{\text{Output} + \text{losses}} \times 100 \\ &= \frac{787.4}{787.4 + 45.6} \times 100 \\ &= 94.5 \text{ per cent.} \end{aligned}$$

$$\begin{aligned} \text{Power-factor} &= \frac{\text{Input}}{3V_1I_1} \times 100 \\ &= \frac{(787.4 + 45.6) \times 1000}{3 \times 1270 \times 238.9} \times 100 \\ &= 91.6 \text{ per cent.} \end{aligned}$$

The torque may be found from the power as on page 510 or it may be found directly from the equations for torque given on pages 462 and 463. It should be remembered that the equations give internal torque. To get external or pulley torque the torque corresponding to friction and windage must be subtracted. The equations give the torque in units corresponding to the units substituted in the equations. If practical units, *i.e.*, volts, amperes and ohms are used, the torque will be expressed in a unit for which there is no name but which is equal to 10^7 centimeter-dynes. To reduce torque in this unit to pound-feet it is necessary to multiply by $\frac{550}{746} = 0.7376$.

$$\begin{aligned} T_2 &= \frac{p}{4\pi f_1} I_2^2 \frac{r_2}{s} \\ &= \frac{12}{4 \times 3.142 \times 25} \times (220.4)^2 \times \frac{0.0992}{0.018} \times 0.7376 \\ &= 7539 \text{ pound-feet.} \end{aligned}$$

$$\begin{aligned} T &= 3T_2 - (\text{friction and windage torque}) \\ &= 3 \times 7539 - \frac{3.1 \times 1000}{2 \times 3.142 \times \frac{2 \times 25}{12} \times (1 - 0.018)} \times 0.7376 \\ &= 22,530 \text{ pound-feet.} \end{aligned}$$

SINGLE-PHASE INDUCTION MOTORS

CHAPTER LII

SINGLE-PHASE INDUCTION MOTOR; WINDINGS; METHOD OF FERRARIS FOR EXPLAINING THE OPERATION OF THE SINGLE-PHASE INDUCTION MOTOR

Single-phase Induction Motor.—The running characteristics of a single-phase induction motor are quite satisfactory, but the motor is not so good as a polyphase motor since it possesses no starting torque. It is also much heavier than a polyphase motor for the same speed and output. The greater weight for a given output is not an inherent peculiarity of the single-phase induction motor alone but is characteristic of any single-phase motor or generator.

A polyphase induction motor has a starting torque which may be increased up to a certain limiting value by putting resistance in the rotor circuit. No amount of resistance inserted in the rotor of a single-phase induction motor can give it an initial starting torque. It must be started by some form of auxiliary device and must attain considerable speed before it will develop sufficient torque to overcome its own friction and windage. The direction of its rotation depends merely upon the direction in which it is started. Once started, it will operate as well in one direction as in the other. This absence of a starting torque and the consequent necessity for some form of auxiliary starting device, are the chief factors which limit the use and size of single-phase induction motors. Motors of this type are not often used in ratings over 10 or 15 hp. except in those cases where only single-phase power is available. Single-phase motors cost from 30 to 60 per cent. more than polyphase motors of the same rating and speed.

Windings.—The general features of construction of a single-phase motor are similar to those of a polyphase motor. The essential difference is in the windings. The stator of a single-phase

motor always has a distributed single-phase winding usually with fractional pitch. The rotor is generally of the squirrel-cage type except when the auxiliary starting torque is obtained by converting the motor into a repulsion motor while coming up to speed. If the repulsion-motor action is not used for starting, the stator must have an auxiliary starting winding or its equivalent, in addition to the regular winding. By subdividing the main winding it is possible to make a part of this serve as the auxiliary winding.

Method of Ferraris for Explaining the Operation of the Single-phase Induction Motor.—Ferraris has given an ingenious and simple explanation of the operation of a single-phase induction motor, but as it omits several important factors it cannot be used for analytical development. It serves a useful purpose, however, in bringing out certain peculiarities in the operating characteristics of the motor.

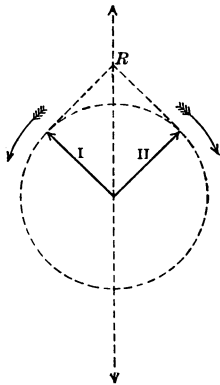

FIG. 227.

Any simple harmonic vector may be resolved into two oppositely rotating vectors, each of the same period as the given vector and of one-half its magnitude (Synchronous generators, page 58). Let the single-phase stator field of the induction motor be replaced by two such revolving vectors (Fig. 227). Each of the revolving component fields I and II acting alone would give rise to a speed-torque curve similar to that of

any polyphase motor. Such a curve is shown for slips between 0 and 200 per cent. in Fig. 228.

If a polyphase motor is driven backwards from rest, its torque decreases. Below standstill or 100 per cent. slip, its torque curve is similar to the portion of the curve between $s = 100$ and $s = 200$ in Fig. 228.

Synchronous speed with respect to field No. I is 200 per cent. slip with respect to field No. II and synchronous speed with respect to field No. II is 200 per cent. slip with respect to field No. I. The torques produced by the two fields are oppositely directed since the fields rotate in opposite directions. The speed-torque curves for the two component revolving fields are shown in

Fig. 229, where the torque produced by field No. I is assumed positive.

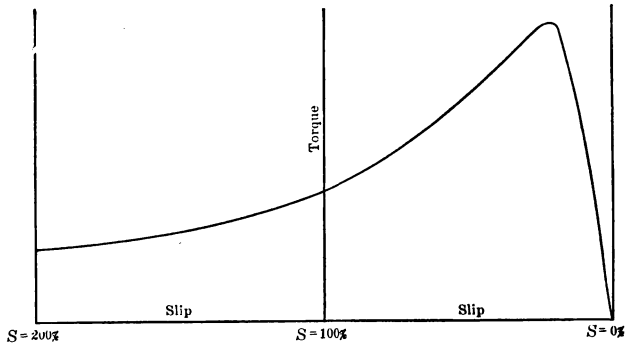

FIG. 228.

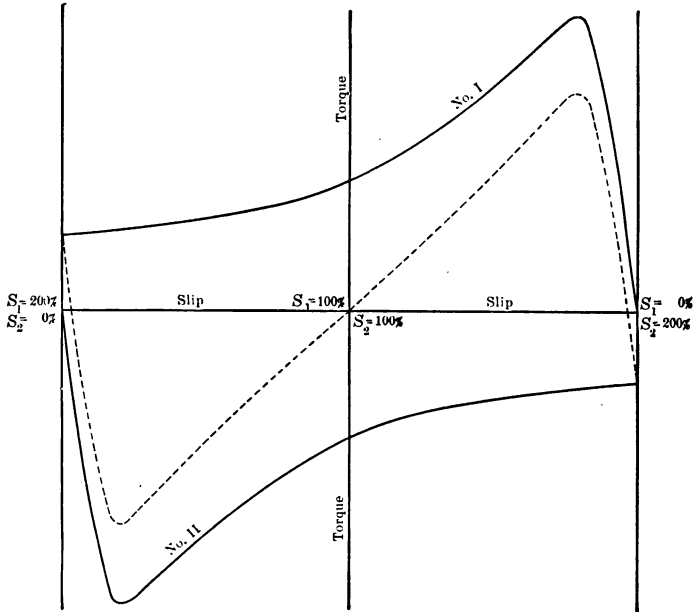

FIG. 229.

The sum of the ordinates of the two torque curves gives the resultant torque curve of the motor. This curve of resultant torque is shown dotted in Fig. 229. When the motor is at rest

the resultant torque is zero, and it becomes zero again slightly below synchronous speed, for either direction of rotation. At other speeds, it has perfectly definite values. If the motor is started in either direction and is brought up to such a speed that the resultant torque is greater than that required for load plus losses, the motor will gain speed until the stable part of the speed-torque curve is reached corresponding to the direction of rotation in which the motor is started.

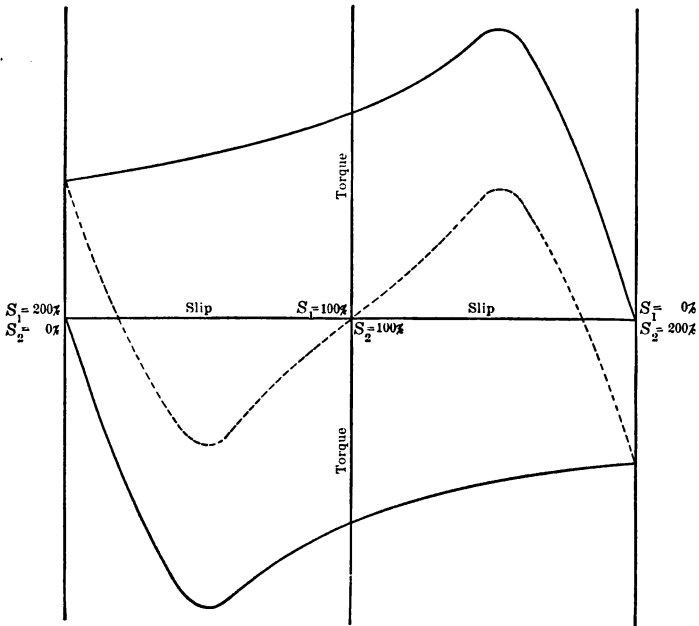

FIG. 230.

One peculiarity of the single-phase induction motor is that its internal torque becomes zero at a speed slightly below synchronous speed. A single-phase induction motor could never reach synchronous speed even if its rotational losses could be made zero. Although the torque of a single-phase induction motor becomes zero before synchronous speed is reached, it can be shown that the change in slip under load is less than the change in slip of a polyphase motor. The slip of a polyphase motor is proportional to the rotor copper loss (equation 188, page

475). For small values of slip, the slip of a single-phase induction motor is very nearly proportional to the square root of the rotor copper loss.

Adding resistance to the rotor of a single-phase induction motor not only increases its slip but decreases its maximum internal torque as well. The maximum internal torque developed by a polyphase motor is independent of rotor resistance (equation 178, page 464). Fig. 230 shows the effect on the torque of adding resistance to the rotor of a single-phase induction motor.

Although the method of Ferraris just outlined serves to explain the general action of the single-phase induction motor, a rigorous analysis must include the reaction of the rotor. This factor is neglected in the method of Ferraris.

The reason why the method of Ferraris for treating the single-phase induction motor fails to give good results is that the two slip-torque curves made use of are tacitly assumed to be for equal and constant voltages. Actually the currents should be equal, not the voltages. The two slip-torque curves corresponding to the oppositely rotating component fields should be for equal currents at each motor speed and not for equal voltages. According to the method of Ferraris, a single-phase induction motor is equivalent to two polyphase induction motors with their rotors mechanically coupled and with their stators connected in parallel to the source of power in such a way as to produce oppositely rotating magnetic fields. In reality, the stators should be connected in series to represent the actual conditions existing in the single-phase induction motor. Most of the voltage drop across the stators in series will occur across the stator producing a field which revolves in the direction of rotation of the system. The slip of the system with respect to this field is small. The torque developed by the field is large. The opposite conditions hold with respect to the other field.

CHAPTER LIII

QUADRATURE FIELD OF THE SINGLE-PHASE INDUCTION MOTOR; REVOLVING FIELD OF THE SINGLE-PHASE INDUCTION MOTOR; EXPLANATION OF THE OPERATION OF THE SINGLE-PHASE IN- DUCTION MOTOR; COMPARISON OF THE LOSSES IN SINGLE- PHASE AND POLYPHASE INDUCTION MOTORS

Quadrature Field of the Single-phase Induction Motor.—At any speed other than zero a single-phase induction motor has a revolving magnetic field, produced by two component fields which are in space quadrature and very nearly in time quadrature. One of these component fields is due to the stator winding and for any given impressed voltage would be constant were it not for the change in the stator impedance drop with change in load. The other component field is due to the current in the rotor produced by its rotation in the stator field. This second or quadrature field varies in magnitude with the speed. It is zero at zero speed and would be equal to the stator field at synchronous speed, were it not for the resistance and leakage-reactance drops in the rotor winding.

The trace of the extremity of the vector which represents the revolving field produced by these two component fields, in quadrature, is very nearly circular at synchronous speed. Both below and above synchronous speed it is elliptical, with the major axis of the ellipse along the stator field below synchronous speed, and at right angles to the stator field above synchronous speed.

Fig. 231 represents diagrammatically a single-phase induction motor with squirrel-cage rotor. *M* is the stator winding, which is distributed in the actual motor.

The axis, *aa*, of the stator field is vertical. The variation in the stator flux induces voltages in the inductors of the squirrel-cage rotor. These voltages act in opposite directions on opposite sides of the axis *aa*. So far as these voltages are concerned,

the armature inductors may be paired off to form a series of closed coils, as indicated by the horizontal lines of Fig. 231. The voltages induced in these coils by a variation in the stator field will set up currents in the coils and these currents will react on the stator winding just as the current in the secondary of a short-circuited static transformer reacts on the primary. So far as concerns the effect of these currents on the stator winding, the rotor winding may be replaced by a single concentrated winding whose axis is coincident with the axis of the stator field and whose sides are *bb*.

When the rotor turns, two component electromotive forces are induced in its inductors by the stator field. One is caused by the transformer action of the stator field and is the same as the electromotive force induced in the rotor when at rest. The other is induced by the movement of the rotor inductors through the stator field due to rotation. The first is a pure transformer voltage, the second a pure speed voltage. The electromotive forces induced in the inductors by the transformer action are in the same direction in all inductors on the same side of the axis, *aa*, of the stator field (Fig. 232). Therefore, the

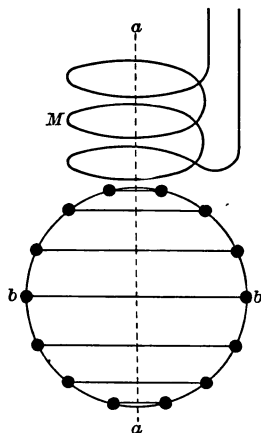

FIG. 231.

axis of the rotor for these voltages is vertical, and any current they cause will react on the stator field. The rotor, so far as the effect of this current is concerned, acts like the closed secondary of a static transformer. For this current the rotor winding has the same effect as an equivalent number of turns concentrated at *bb*.

The application of the right-hand rule will show that the voltages induced in the rotor inductors by their movement through the stator field will act in the same direction in all inductors above the horizontal axis (Fig. 233) and in the opposite direction in all inductors below that axis. The axis of the rotor for these voltages is horizontal, therefore, and any currents they cause will react on the stator along a horizontal axis. So far as con-

cerns the effect of these currents on the stator, the rotor winding may be replaced by a single concentrated winding having its axis at right angles to the axis of the stator field and its sides at aa .

Since the axis for the speed electromotive forces is horizontal, *i.e.*, at right angles to the stator field, any currents these electromotive forces may cause can have no electromagnetic reaction on the stator winding.

The axes of the rotor, for the two component electromotive forces induced in it by the stator field are at right angles or in space quadrature. Both component electromotive forces are produced in the same inductors by the same flux. The trans-

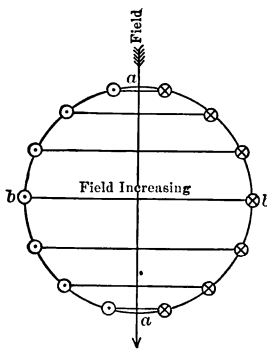

FIG. 232.

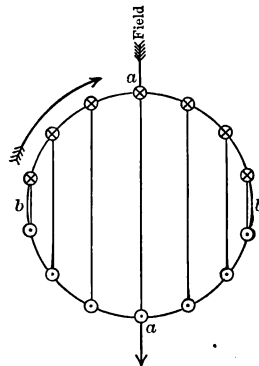

FIG. 233.

former voltage is in time quadrature with the stator flux. The speed voltage is produced by a movement of the inductors across the stator field at a speed which is constant for any fixed load. The speed voltage, therefore, must be directly proportional to the stator field at every instant. The two component voltages, therefore, are in time quadrature.

That component of the rotor current which may be considered as due to the rotation of the rotor in the stator field gives rise to a field which has its axis along bb , that is, in space quadrature with the axis of the stator field. Since there is no winding on the stator or on any other part of the motor upon which this current can react electromagnetically, the rotor must act, so far as this current and, therefore, so far as the axis bb is concerned,

like a reactance coil. It is equivalent to a single winding on a magnetic circuit with two air gaps. Its reactance for the axis bb must be high. The current producing the quadrature field, therefore, must lag nearly 90 degrees behind the speed voltage. Since the maximum of the speed voltage coincides in time with the maximum of the stator flux, it follows that the current producing the quadrature field, and hence the quadrature field itself, are both nearly in time quadrature with the stator field.

The two component currents in the rotor will be considered separately and will be referred to the stator as was the rotor current of the polyphase induction motor. All voltages induced in the rotor will also be referred to the stator. The actual current in a rotor inductor is the vector sum of the two component currents. The component currents in the rotor when referred to the stator will be designated by the letter I with a subscript, a or b , to indicate along which axis they react. For example I_b is the component current producing an armature magnetic axis which coincides with the axis bb . It is the component current producing the quadrature field. Three subscripts must be used with the component voltages: one, a or b , to indicate the armature axis to which it belongs; a second, M or Q , to indicate whether it is produced by the main or stator field or by the quadrature field; a third, T or S , to indicate whether a transformer or a speed voltage is intended. For example, E_{bMS} is the speed voltage induced in the rotor by its rotation in the stator field M . It produces a component current I_b in the armature which reacts along the axis bb .

Let φ_M and φ_Q be the stator and the quadrature fields, respectively, then

$$E_{aMT} = KN\varphi_M f \quad (211)$$

and

$$E_{bMS} = KN\varphi_M n \quad (212)$$

where

K = a constant

N = the number of turns on the rotor referred to the stator

f = frequency

n = speed in revolutions per second multiplied by the number of pairs of poles.

At synchronous speed f and n are equal. Hence E_{bMS} and E_{aMT}

must be equal at synchronous speed. This assumes a sinusoidal time variation and a sinusoidal space distribution of the flux.

The quadrature field, φ_Q , will produce two voltages in the rotor, a speed voltage and a transformer voltage. These voltages are

$$E_{aQS} = KN\varphi_Q n \quad (213)$$

and

$$E_{bQT} = KN\varphi_Q f \quad (214)$$

These voltages are also equal at synchronous speed. Since the rotor is short-circuited the component current I_b at any speed will have such a value that the vector sum of E_{bMS} and E_{bQT} equals the impedance drop in the rotor.

The transformer voltage, E_{bQT} , is in reality a reactance voltage produced by the quadrature flux φ_Q .

$$E_{bMS} + E_{bQT} = I_b(r + jx) \quad (215)$$

Since the voltages and the current are referred to the stator, r and x must also be referred to the stator. The r 's for the two equivalent windings which have replaced the rotor winding must be equal. The x 's must also be equal.

From equations (212), (214) and (215) it follows that

$$KN\varphi_M n + KN\varphi_Q f = I_b(r + jx).$$

Under operating conditions, the impedance drop, $I_b(r + jx)$, will be small, as compared with the two voltages, E_{bMS} and E_{bQT} . Hence, neglecting this drop

$$-\frac{\varphi_M}{\varphi_Q} = \frac{f}{n}.$$

Therefore, if the rotor impedance drop, $I_b(r + jx)$, be neglected, the main and quadrature fields are equal at synchronous speed since f and n are equal at that speed. Actually at synchronous speed φ_Q is slightly less than φ_M on account of the rotor impedance drop. Below synchronous speed φ_Q is less than φ_M since φ_Q varies with the speed. The two fields are always in space quadrature and are nearly in time quadrature. The two fields are shown in Fig. 234.

Revolving Field of the Single-phase Induction Motor.—The two fields φ_M and φ_Q are in space quadrature and very nearly in

time quadrature, and will combine to produce a revolving magnetic field. At synchronous speed these two component fields are sensibly equal and the end of the vector which represents their resultant will trace a circle. Below synchronous speed the quadrature field is less than the main or stator field and the trace will be an ellipse with the major axis along the stator field, shown dotted, Fig. 234. Above synchronous speed the trace will still be an ellipse but its major axis will be at right angles to the stator field, shown dot and dash, Fig. 234. Only at synchronous speed will the resultant field be constant and revolve at constant speed. When the motor is at rest the quadrature field becomes zero and the dotted ellipse then becomes a straight line.

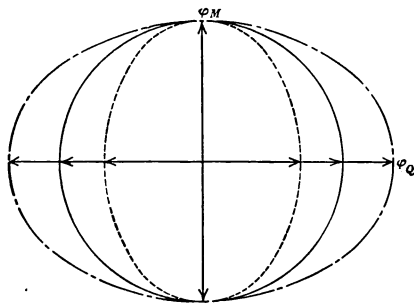

FIG. 234.

Explanation of the Operation of the Single-phase Induction Motor.—For a motor to produce torque, the axis of the magnetic field due to its armature current must not be in space phase with the axis of the air-gap flux. The air-gap flux must not be in time quadrature with the armature current. The first of these conditions will be made clear by considering a direct-current motor. The magnetic axis of the armature winding of a direct-current motor coincides with the brush axis. If the brushes of such a motor be moved so that the armature axis coincides with the field axis, the torque becomes zero. Under this condition, the two quarters of the armature on the same side of the brush axis produce torque in opposite directions and their effects neutralize. If the axis of the armature and of the field are in space quadrature, the torque produced by all armature inductors acts in the same direction. The average torque throughout a cycle

will be zero unless the armature current and the air-gap flux have components in time phase.

At rest, a single-phase induction motor has a rotor current which is produced by the transformer action of the stator flux. For this current the magnetic axis of the rotor has been shown to coincide with the axis of the stator field. The resultant air-gap flux, therefore, is in space phase with this rotor axis. The torque is zero. When the motor is running, the field φ_Q , due to the component current produced in the rotor by rotation, has its axis in space quadrature with the stator field. This field φ_Q will, therefore, develop torque with the current produced in the rotor by the transformer action of the stator flux provided φ_Q and this current are not in time quadrature.

So far as the component current produced by the speed voltage is concerned, the rotor has a magnetic axis which is at right angles to the stator field. This component current, therefore, may develop torque with the stator field. Since the magnetic axis for this component current is at right angles to the stator field, the current cannot react on the stator and hence cannot cause any change in the stator current. Therefore, the power developed by this component current cannot be directly supplied by the stator. It must be a part of the power developed by the rotation of the armature. This current may be considered as made up of a magnetizing component for the quadrature field and a power component supplying the core loss of that field. This current involves power developed and, therefore, corresponds to generator action. Since there is no reaction between the stator and this current, the power must be supplied through an equivalent current in the rotor producing an equal motor action. The axis of the field due to this motor current must coincide with the axis of the stator. Hence it will react on the stator to produce an equivalent current in the stator winding. The component current producing the quadrature field and supplying its core losses thus has its equivalent current in the stator.

A single-phase induction motor is in a sense a motor generator, since both motor and generator power are developed in its armature. In addition to motor power, it must develop sufficient generator power to supply the exciting current for the quadrature field. So far as the axis aa is concerned, the rotor acts as a motor.

With respect to the axis *bb* the rotor acts as a generator. Under load conditions, the generator action is small compared with the motor action. Above synchronous speed, only generator action is developed with respect to both axes.

Although the single-phase induction motor has a revolving magnetic field, the simple explanation of the operation of a polyphase motor, based on its revolving magnetic field, cannot be applied to a single-phase induction motor, since the quadrature field is not produced by a stator winding. Also there is no winding on the stator inductively related to the current which produces the quadrature field, and hence no reaction on such a winding.

The complete analysis of the operation of the single-phase induction motor is not simple. The action of such a motor may be best understood by a study of its vector diagram. On account of the motor-generator action in the armature, this diagram is somewhat complicated.

Comparison of the Losses in Single-phase and Polyphase Induction Motors.—The losses of a single-phase induction motor are greater than those of a polyphase motor of the same speed and rating. This is due in part to the inherently greater losses of any single-phase motor or generator and in part due to conditions which are peculiar to the single-phase induction motor alone.

To secure a satisfactory flux distribution and also to distribute the stator copper loss over as much of the stator surface as possible, it is necessary to use a greater phase spread for the stator winding in a single-phase motor than in the stator winding of a polyphase motor. The stator winding in a single-phase motor is often tapered off at the edges of the phase belt to improve the flux distribution. Tapering off means the use of fewer inductors in the end slots of a phase belt. This tapering-off effect may be obtained by a regular three-phase fractional-pitch winding on the stator, using two of the phases in series for the one phase of the single-phase motor. The third phase is used for starting only. The overlapping of the phases in a three-phase fractional-pitch winding gives one-half as many inductors in the end slots of the phase belt as there are in the central slots.

With a phase spread of 60 degrees, the stator winding of a three-phase induction motor covers the entire armature surface.

For the stator winding of a single-phase motor to cover the entire armature surface, a phase spread of 180 degrees would be necessary. A spread of 180 degrees would not be used in practice on account of the differential action of the end turns and the resulting low breadth factor of the winding.

Most induction motors have fractional-pitch windings. Assuming a three-phase motor with a $\frac{5}{6}$ pitch and a 60-degree phase spread, the total reduction factor, *i.e.*, the breadth factor multiplied by the pitch factor, is 0.92. Equations (3) and (8), pages 41 and 44. The total reduction factor for a single-phase motor, using two phases of a three-phase *Y*-connected winding with a $\frac{5}{6}$ pitch, is about 0.80. For the same magnetomotive force the single-phase motor would require approximately 15 per cent. more ampere-turns than the three-phase motor for the same rotor current. This would result in a corresponding increase in the stator copper loss or in an increase in the amount of copper required for the stator winding. The stator copper loss of a single-phase motor is in general, greater than the corresponding loss for a three-phase motor. This greater stator copper loss is not peculiar to the single-phase induction motor but exists in any single-phase motor or generator as compared with one of the polyphase type.

The frequency of the rotor current of a polyphase motor is f_1s where f_1 is the stator frequency and s is the slip. This frequency, f_1s , is low, especially for large motors, which at full load may have a slip of as low as 2 per cent. The local losses in the rotor, caused by the rotor leakage flux, are negligible on account of this low frequency.

The current in each rotor inductor of a single-phase motor is the vector sum of two component currents, one due to the transformer action of the stator, and the other due to the speed voltage produced by the stator field. Both of these component currents have stator frequency when referred to the stator. When referred to the rotor one has a frequency $f_2 = f_1s$, the other has a frequency $f_2' = (2 - s)f_1$. For ordinary values of slip the first of these frequencies is very low, the second, however, is nearly twice primary frequency. The effect of the double-frequency component is to somewhat increase the loss due to the resultant rotor current and to make the apparent

resistance of the rotor slightly greater than the ohmic resistance. There is no corresponding double-frequency component in the rotor current of a polyphase induction motor.

Another factor which tends to increase the copper loss of a single-phase motor is the magnetizing current for the quadrature field. This magnetizing current is carried by the rotor winding. No such magnetizing current exists in the rotor winding of a polyphase motor. The stator of a single-phase motor carries the magnetizing current for the main field and an equivalent of the magnetizing current for the quadrature field.

In a polyphase motor, the core loss produced in the rotor by the revolving field, neglecting the effect of harmonics in the stator flux, is due to a flux which has a frequency with respect to the rotor equal to stator frequency times slip. For the small slip at which an induction motor usually operates, this loss is generally negligible. A single-phase induction motor also has a revolving field. This field is not constant in magnitude except at synchronous speed. In general it may be resolved into two components: one, a revolving field, which has a constant strength equal to the maximum value of the quadrature field; the other, an oscillating field with its axis along the stator axis. The latter component has a maximum value equal to the difference between the maximum values of the stator and quadrature fields. The oscillating component produces a flux variation of two frequencies in the rotor. If φ_m is the maximum value of the oscillating component and s is the slip, the oscillating flux in the rotor is

$$\begin{aligned} &= \varphi_m \sin \omega t \sin (1 - s) \omega t \\ &= \frac{1}{2} \varphi_m \cos s \omega t - \frac{1}{2} \varphi_m \cos (2 - s) \omega t^* \end{aligned}$$

The frequency of the first component of the flux is stator frequency times slip, while that of the second component is twice stator frequency minus stator frequency times slip. The second component has, therefore, nearly twice stator frequency. The rotor core loss due to the first component is negligible but the core loss due to the second component cannot be neglected. This second component tends to make the core loss per unit volume in the rotor of a single-phase induction motor

* "Synchronous Generators," p. 59.

slightly greater than the core loss per unit volume of the rotor of a polyphase induction motor.

The chief factor which makes the core loss of a single-phase motor greater than that of a polyphase motor of the same speed and rating is the greater amount of iron necessary in both rotor and stator of the single-phase motor. For the same inductor copper loss, a three-phase generator or motor when operated single-phase can deliver only about 50 to 57 per cent. of its rated three-phase output. If the motor or generator be rewound for single-phase operation only, its single-phase rating can be somewhat increased, but will still be much below the polyphase rating. It follows, therefore, that a single-phase induction motor must have nearly twice as much iron as a three-phase motor of the same speed and output with a corresponding greater core loss.

The losses of a single-phase induction motor are then inherently greater than those of a polyphase motor of the same rating and speed, and thus the efficiencies of single-phase induction motors are less than those of corresponding polyphase motors. The single-phase motor is heavier since it requires much more iron.

The power factors of single-phase induction motors are inherently less than the power factors of polyphase induction motors. As the output of a single-phase induction motor is only about 50 per cent. as great as the output of a polyphase motor of the same weight, the power component of the stator current of a single-phase induction motor is only about equal to the power component of the current in one phase of a two-phase motor of the same weight. The stator winding of a single-phase motor carries the magnetizing current for both the main field and the quadrature field, and is, therefore, about twice as large as the magnetizing current of one phase of the two-phase motor. The ratio of magnetizing current to power current in the stator of a single-phase motor, therefore, is much greater than the ratio of the same currents for a two-phase motor or in general for a polyphase motor. It follows, therefore, that the power factor of a single-phase motor is less than the power factor of a polyphase motor of the same speed and output.

CHAPTER LIV

VECTOR DIAGRAM OF THE SINGLE-PHASE INDUCTION MOTOR; GENERATOR ACTION OF THE SINGLE-PHASE INDUCTION MOTOR

Vector Diagram of the Single-phase Induction Motor.—For convenience of reference, the main or stator field will be represented by the poles MM and the quadrature field caused by the armature, by the poles QQ , Fig. 235. The actual motor, of course, does not have projecting poles. All vectors will be referred to the stator.

At Synchronous Speed.—Consider first the conditions existing in the motor when driven up to synchronous speed from some outside source of power. Assume the direction of rotation of the armature to be clockwise. In the armature there are two voltages to consider with respect to each of the two axes, aa and bb , a transformer voltage and a speed voltage.

A transformer voltage is 90 degrees behind the flux producing it. Some convention must be adopted for determining the time-phase relation between speed voltage and the flux producing it. The maximum values occur at the same time, but may not be of the same sign.

The positive direction of the stator flux may be arbitrarily assumed. This, with the direction of rotation of the armature, fixes the positive direction of the quadrature flux. The revolving magnetic field of the motor must progress in the direction in which the armature rotates. Therefore, if upward fluxes, Fig. 235, are assumed to be positive for the poles MM , a clockwise

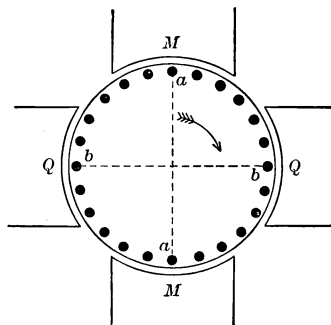

FIG. 235.

rotation of the armature will make from left to right positive flux for the quadrature field, QQ .

A current in a coil is positive if it produces a positive flux. A speed voltage is positive if the current due to this voltage would produce a positive flux.

The time-phase vector diagram for a single-phase induction motor at synchronous speed is given in Fig. 236, in which the stator flux is drawn positive.

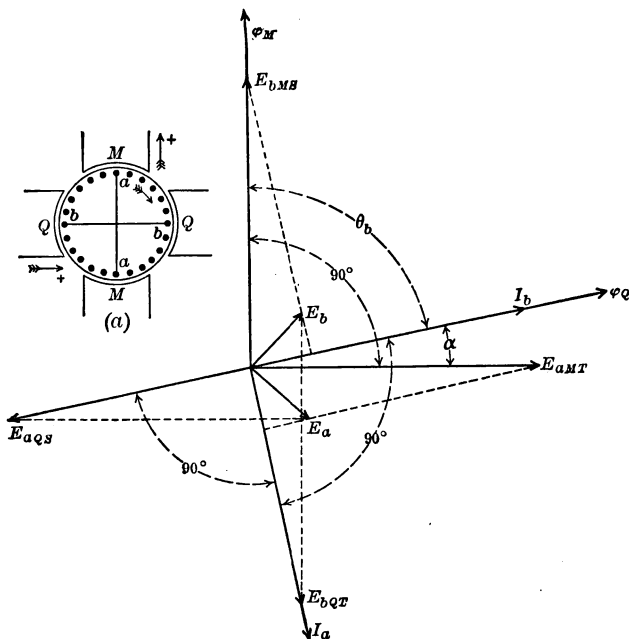

FIG. 236.

The rotation of the rotor in the stator field, MM , induces a component electromotive force, E_{bMS} . Applying Fleming's right-hand rule, it will be seen that this acts outward in all inductors above the horizontal axis and inward in all inductors below that axis. According to the convention adopted for determining the sign of a speed voltage, this voltage is positive. The component current I_b set up by this voltage reacts along the quadrature axis. It is largely a magnetizing current, and lags nearly 90 degrees behind the voltage producing it. To avoid unnecessary

confusion in the diagram, the quadrature flux, φ_Q , caused by I_b is assumed to be in phase with I_b . The flux φ_Q will be a little less than the flux φ_M on account of the resistance and leakage-reactance drops in the armature (page 520).

The flux φ_Q produces a transformer voltage E_{bQT} in the armature inductors. The flux φ_M also produces a transformer voltage E_{aMT} but the axis of the armature for E_{aMT} is in space quadrature to its axis for E_{bQT} . Due to the rotation of the armature in the field φ_Q a speed voltage E_{aQS} is induced. According to the right-hand rule and the convention already adopted, this voltage is negative.

The voltages E_{bMS} and E_{aMT} are caused by the same flux, and since the speed times $\frac{p}{2}$ and the stator frequency are equal at synchronous speed, the two voltages are equal (page 519). Similarly, the voltages E_{bQT} and E_{aQS} are equal but slightly less than the voltages E_{bMS} and E_{aMT} . This difference in magnitude results from the slight differences in the magnitudes of the fields φ_M and φ_Q caused by the armature leakage-impedance drop.

The current I_b is equal to the resultant voltage E_b divided by the leakage impedance of the armature. Similarly, the current I_a is equal to the resultant voltage E_a divided by the leakage impedance of the armature. E_{aMT} is equal to E_{bMS} and 90 time degrees behind it. Also, E_{aQS} is equal to E_{bQT} and 90 time degrees behind it. Therefore, E_b and E_a are equal and in time quadrature. Since the resistance and leakage reactance of the armature along the two axes aa and bb must be equal, the currents produced by the voltages E_b and E_a must also be equal. These currents are in time quadrature since the voltages E_b and E_a producing them are in time quadrature.

Referring to Fig. 236*a*, it is evident that the current I_b can produce torque only with the flux φ_M and the current I_a can produce torque only with the flux φ_Q . The power developed by a motor or generator is always equal to the product of the projection of the armature current on the speed voltage. From Fig. 236, it may be seen that I_b has a positive projection on its speed voltage, E_{bMS} , and produces generator action. The current I_a is in time quadrature with its speed voltage, E_{aQS} , and produces neither motor nor generator action. To bring the motor up to synchro-

nous speed, mechanical power must be supplied to the pulley, in excess of the friction and windage losses, by an amount equal to the product of the voltage E_{bMS} and the energy component of the current I_b with respect to E_{bMS} . This mechanical power is equal to the core loss due to the quadrature field plus a small copper loss in the armature.

The current I_a reacts on the stator by transformer action and produces an equivalent current in the stator winding. The current I_b which is the magnetizing current for the field QQ cannot react on the stator. Due to the rotation of the armature, however, an equal component current I_a appears in the armature and this component does react on the stator. The magnetizing current of the quadrature field is thus transferred to the stator winding owing to the rotation of the armature. In addition to this transferred current, the stator carries a magnetizing and core-loss current for its own field. The stator, consequently, carries a current which is equal to the sum of the magnetizing currents for the main and quadrature fields.

It should now be clear that a single-phase induction motor cannot reach synchronous speed even at no load. To get it up to that speed, sufficient power would have to be supplied to meet the core loss of the quadrature field even if there were no friction and windage and copper losses. On the other hand, a polyphase induction motor would run at synchronous speed at no load if it had no friction and windage losses.

Below Synchronous Speed.—If the mechanical power which drives the motor up to synchronous speed be removed, the motor will slow down and the speed voltage E_{bMS} will decrease. The current I_b will also decrease, as will the flux φ_Q . The voltage E_{aQS} decreases more rapidly even, first on account of the decrease in the speed and second on account of the decrease in the flux φ_Q . The voltage E_{aQS} is approximately proportional to the square of the speed.

If the reluctance of the magnetic circuit for the quadrature field is assumed constant, the flux φ_Q and the current I_b will be proportional to each other and

$$E_{bQT} = KN\varphi_Qf$$

may be written

$$E_{bQT} = K'NI_bf$$

K' and N are constant and if f be assumed constant

$$E_{bQT} = - I_b X.$$

where X is the total reactance of the rotor winding considered with respect to the axis bb . It is assumed constant. The minus sign is used because E_{bQT} is a voltage rise and $I_b X$ is a voltage drop.

E_{bQT} is thus a reactance voltage.

$$\begin{aligned} E_{bMS} + E_{bQT} &= I_b(r + jx) \\ E_{bMS} - I_b X &= I_b(r + jx) \\ I_b &= \frac{E_{bMS}}{r + j(x + X)} \\ \cos \theta_b &= \frac{r}{\sqrt{r^2 + (x + X)^2}} \end{aligned} \quad (216)$$

Therefore, $\cos \theta_b$ is constant, since r and x are sensibly constant and X is assumed constant. For ordinary variations in speed such as those produced by a change in load, X would be very nearly constant. Since $\cos \theta_b$ is constant for moderate changes in speed, the current I_b , Fig. 236, will decrease in magnitude but not alter in direction as the motor is loaded. As the motor slows down, the generator action of the current I_b will decrease. This decrease results from the decrease in the core loss of the quadrature field, due to the decrease in φ_Q .

The conditions for the other component current, I_a , are different. The voltage E_{aMT} is constant assuming φ_M to be constant, while the voltage E_{aQS} varies as the square of the speed. The decrease in speed causes E_a , Fig. 236, to rotate counter-clockwise, carrying with it the current I_a which at the same time increases. The current I_a will now have a negative projection on its speed voltage E_{aQS} . This negative projection represents motor action. If there were no copper loss and no friction and windage losses, the motor would run at such a speed below synchronism that the motor power developed by I_a was just equal to the generator power developed by I_b . This generator power supplies the core loss of the quadrature field.

If the load be now applied, the motor will slow down, until at a certain small slip the motor action of I_a becomes enough

greater than the friction and windage and the generator action of I_b to cause a net motor power sufficient to enable the motor to carry its load. In general, the change in the slip of a single-phase motor for a given change in load will be less than for a corresponding polyphase motor. The back electromotive force E_{aQS} of the single-phase motor varies with the square of the speed while the back electromotive force $E_2(1 - s)$ of a polyphase motor varies as the first power of the speed. The slip of a single-phase induction motor can be shown to be nearly proportional to the square root of the rotor copper loss. The slip of a polyphase induction motor has been shown to be proportional to the first power of the rotor copper loss.

It should be noticed that the component current, I_a , whose magnetic axis lies along the stator field, is the power current of the motor. The other component current, I_b , is merely the magnetizing current for the quadrature field. The current I_a in conjunction with this quadrature field produces the power output of the single-phase induction motor.

Generator Action of the Single-phase Induction Motor.—If driven above synchronous speed, the single-phase induction motor will act as a generator. If such a motor be speeded up from below synchronous speed, the net internal motor power decreases and becomes zero at some small positive slip below synchronism. At this slip, the internal motor power developed is just equal to the core loss caused by the quadrature field. Above the speed corresponding to this slip, the mechanical power applied to the pulley commences to supply the core loss of the quadrature field. At synchronous speed no internal motor power is developed and all of the core loss of the quadrature field is supplied by the mechanical power. Above synchronous speed generator action is developed along the axis aa and the mechanical power commences to supply the core loss caused by the stator field, MM . At some small negative slip above synchronism, both core losses are supplied by the mechanical power. Above this slip net generator power is developed and power is delivered to the circuit to which the motor is connected. Like a polyphase induction generator, the single-phase induction generator delivers only leading current at a power factor which is fixed by its constants and the slip and not by the load.

CHAPTER LV

COMMUTATOR-TYPE, SINGLE-PHASE, INDUCTION MOTOR; POWER-FACTOR COMPENSATION; VECTOR DIAGRAMS OF THE COMPENSATED MOTOR; SPEED CONTROL OF THE COMMUTATOR-TYPE, SINGLE-PHASE, INDUCTION MOTOR; COMMUTATION OF THE COMMUTATOR-TYPE, SINGLE-PHASE, INDUCTION MOTOR

Commutator-type, Single-phase, Induction Motor.—A drum-wound rotor, similar to the armature of a direct-current motor, may be used for the single-phase induction motor, in place of a rotor of the squirrel-cage type. The magnetic field produced by any direct-current armature has its axis along the line connecting the brushes.

So far as reaction is concerned, such an armature is equivalent to a single coil placed on the armature with its plane perpendicular to the brush axis. When a drum armature is used in a single-phase induction motor, two pairs of brushes per pair of poles are required: one, short-circuiting the armature along a diameter parallel to the axis of the stator field, MM , and the other, short-circuiting the armature along a diameter at right angles to MM or along the axis of the quadrature field, QQ .

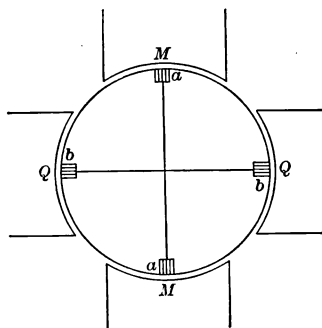

FIG. 237.

Let Fig. 237 represent the motor. The short-circuiting brushes are aa and bb .

The magnetic axis of the armature for any current passing between the brushes aa coincides with the axis of the stator field, MM . The magnetic axis of the armature for any current passing between the brushes bb coincides with the axis of the quadrature field, QQ . This latter field does not exist at standstill.

The stator field, MM , produces a transformer voltage, E_{aMT} , between the brushes aa . The rotation of the armature in the field MM induces a speed voltage, E_{bMS} , between the brushes bb . The quadrature field, QQ , also produces two voltages in the armature: one, a transformer voltage, E_{bQT} , between the brushes bb ; the other, a speed voltage, E_{aQS} , between the brushes aa . All four voltages are assumed to be referred to the stator. They have the same effect as the corresponding voltages of the single-phase induction motor when operating with a squirrel-cage rotor.

The current I_a between the brushes aa produces the motor power. The current I_b between the brushes bb is the magnetizing current for the quadrature field. The brushes aa may be called the power brushes since they carry the current which produces the motor power. The brushes bb carry the current for the quadrature field and may, for this reason, be called the field brushes. The actual current carried by the rotor inductors is either the vector sum or difference of the currents I_a and I_b according to which quarter of the rotor is considered. When these currents are used in the vector diagram, they are referred to the stator.

A motor with a drum-wound rotor, short-circuited along two diameters, Fig. 237, operates exactly like a motor with a squirrel-cage rotor. The vector diagrams of the two types of motor are the same. The addition of the commutator and the short-circuited brushes, however, makes it possible to control the power factor of the motor and also to vary its speed over a considerable range, both above and below synchronism. As low as one-half synchronous speed may be obtained in practice. The motor may also be operated above synchronous speed. There is no object of using a drum-wound armature except to secure one or both of these results.

Power-factor Compensation.—The single-phase induction motor may be compensated for power factor by inserting a voltage in the brush circuit bb to cause the resultant voltage E_a (Fig. 236, page 528) to rotate in the direction of lead until the current I_a , which lags behind the voltage E_a by a fixed angle, leads the transformer voltage E_{aMT} . The angle by which I_a lags behind E_a is fixed by the leakage reactance and the resistance of the rotor.

A voltage which is in phase with that induced in the rotor by the transformer action of the stator field will rotate the voltage E_a in the desired direction. With this voltage inserted between the brushes bb , the component of the stator current which balances the demagnetizing effect of the rotor current I_a will lead the voltage induced in the stator by the stator flux. By giving this component of the stator current sufficient lead, the quadrature component may be made to neutralize the lagging magnetizing current carried by the stator. The magnetizing current is thus transferred to the rotor. The voltage required for power-factor compensation may be obtained from a compensating winding placed in the stator slots with the regular stator winding. The brushes bb instead of being short-circuited are connected to the terminals of this winding. The voltage induced in the compensating winding will be in phase with the voltage E_{aMT} (Fig. 236, page 528) when considered with respect to the stator, but when considered with respect to the rotor, it may be either in phase with or in opposition to the voltage E_{aMT} according to the way the terminals of the compensating winding are connected to the brushes bb . Reversing the connections of the compensating coil with respect to the brushes bb reverses the phase of the voltage inserted in the rotor with respect to the voltage E_{aMT} in the rotor. The compensating field should be connected so as to make the inserted voltage in phase with E_{aMT} . Instead of having a separate winding for the compensation, the regular stator winding may be made to serve the purpose by bringing out two taps from suitable points. When this is done, the stator winding acts both as the primary winding with respect to the armature and as the compensating winding.

Vector Diagrams of the Compensated Motor.—The vector diagram of the compensated motor is shown in Fig. 238. This is similar to the diagram in Fig. 236, page 528, except that the voltage inserted by the compensating coil has been added. Referring to Fig. 238, let E_{bC} be the voltage induced in the compensating winding. The voltage E_{bR} causing the current in the armature between the brushes bb is the vector sum of E_{bMS} and E_{bC} , Fig. 238. This is balanced by the voltage E_{bQT} together with the leakage-reactance and resistance drops due to I_b in the rotor and in the compensating winding. The current I_b is proportional to E_{bR} and lags behind that voltage by nearly 90

degrees just as it did behind the voltage E_{bMS} in the case of the uncompensated motor. The result of adding the voltage E_{bC} to the circuit bb is to rotate the current I_b and with it the quadrature flux φ_Q so that φ_Q lags by more than 90 degrees behind the voltage E_{bMS} .

The resultant voltage E_a causing the current in the power circuit of the motor, now leads E_{aMT} instead of lagging behind it as in the uncompensated motor (Fig. 236). As a result, the

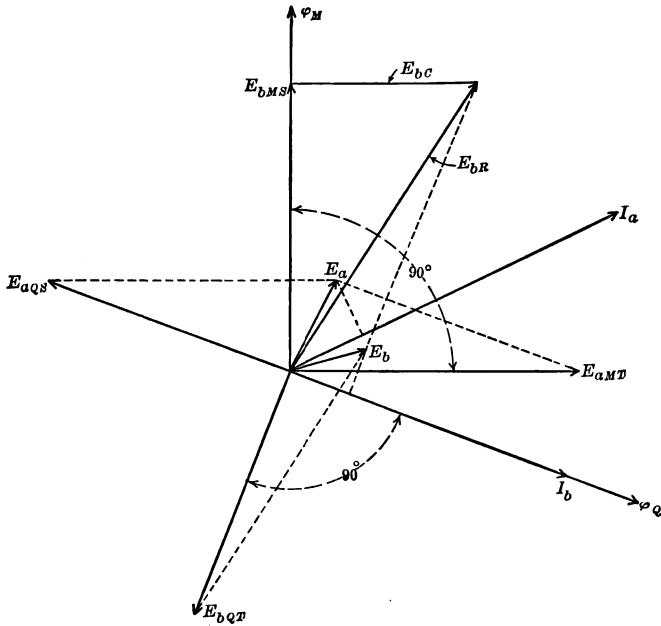

FIG. 238.

current I_a (Fig. 238) leads the transformer voltage E_{aMT} by an amount which depends upon the magnitude of the voltage E_{bC} inserted in the brush circuit bb . The current I_a reacts on the stator and causes by transformer action an equivalent and opposite current I'_1 to flow in the stator winding. If I_a leads the voltage E_{aMT} the equivalent stator current I'_1 will lead the component voltage $-E_1$ which must be impressed on the stator to balance the voltage $E_1 = E_{aMT}$ induced in the stator winding by the

flux φ_M . The flux φ_M corresponds to the mutual flux of a static transformer.

The vector diagram of the transformer formed by the stator winding and the rotor winding considered with respect to the brushes aa is shown in Fig. 239. Everything is referred to the stator. The current I_b cannot react on the stator winding directly since the axis of the field, φ_Q , produced by it is in space quadrature with the axis of the stator winding.

The vector diagram, Fig. 239, shows the condition of perfect compensation, *i.e.*, the condition of unity power factor with respect to the stator. The power factor of the motor, *i.e.*, of V_1 with respect to I_1 , may be varied by altering the number of

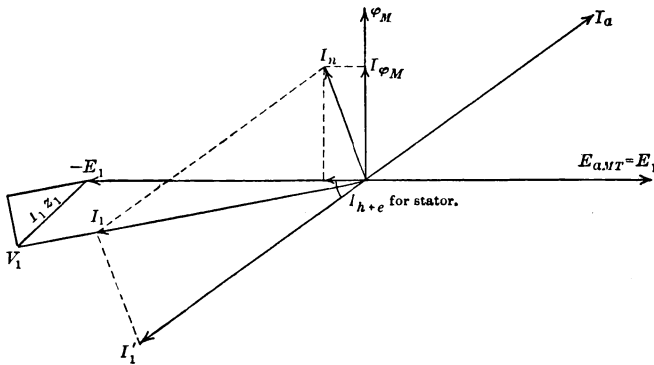

FIG. 239.

turns on the compensating winding. It may be made unity at any desired load. The current I_1 may even be made to lead V_1 if desired. The amount of compensation depends not only upon the number of turns in the compensating winding, but also upon the speed of the motor. As the induction motor is essentially a constant-speed motor, its power factor may be made high at all loads and unity at some particular load. By varying and reversing the voltage of the compensating winding, it is possible to get performance curves similar to the V-curve for a synchronous motor.

So far as the stator is concerned, the compensating winding is a secondary winding carrying a current I_b . Strictly, there should be a second secondary current I_b added to I_a in Fig. 239,

but as the compensating winding has few turns compared to the main stator winding, the current I_b when referred to the stator is small relatively to I_a . For this reason, it is omitted in Fig. 239.

It should be noticed that the magnetizing current I_{φ_M} in the stator is neutralized by compensation and can have no effect in producing flux. The component current which produces the mutual flux under this condition is the leading component of the rotor current. By compensation the magnetizing current is transferred from the stator to the rotor and, in a sense, the motor is made to generate its own magnetizing current.

Speed Control of the Commutator-type, Single-phase, Induction Motor.—There are two ways of varying the speed of a commutator-type, single-phase, induction motor. (a) By inserting a voltage between the brushes aa in phase with or in opposition to the transformer voltage induced between the brushes aa by the stator field. This is analogous to varying the voltage impressed on the armature of a shunt motor. (b) By inserting a voltage between the brushes bb which is in phase with or in opposition to the speed voltage generated between the brushes bb by the stator field. This is analogous to varying the field excitation of a shunt motor.

Method (a).—Let the slip be s . If the frequency, f , is assumed constant, equations (212) and (213), pages 519 and 520, may be written

$$E_{bMS} = KN\varphi_M n = K'\varphi_M(1 - s) \quad (217)$$

$$E_{aQS} = KN\varphi_Q n = K'\varphi_Q(1 - s) \quad (218)$$

If the flux φ_Q is assumed to be proportional to the current causing it,

$$\varphi_Q = kI_b = k'E_{bMS} \quad (219)$$

$$= k''\varphi_M(1 - s) \quad (220)$$

(equations (216) and (217), pages 531 and 538).

Except for the primary impedance drop, φ_M is constant. Assuming φ_M to be constant and replacing φ_Q in equation (218) by its value from equation (220)

$$E_{aQS} = K''(1 - s)^2 \quad (221)$$

Since φ_Q and φ_M are equal at synchronous speed (page 520),

it follows from equations 211 and 213, (pages 519 and 520), that E_{aMT} and E_{aQS} are also equal at synchronous speed. Therefore, K'' in equation (221) is equal to E_{aMT} . Hence, at any speed

$$\begin{aligned} E_{aQS} &= E_{aMT}(1 - s)^2 \\ &= E_{aMT} (\text{speed})^2 \left(\frac{p}{2f}\right)^2 \end{aligned}$$

and

$$\text{speed} = \frac{2f}{p} \sqrt{\frac{E_{aQS}}{E_{aMT}}} \quad (222)$$

where p is the number of poles and f the frequency. Equation (222) gives the speed in revolutions per second.

Let an electromotive force e , either in phase with or in opposition to E_{aMT} be inserted in the brush circuit aa , Fig. 237. Neglecting the resistance and leakage-reactance drops in the armature, the motor must change its speed until

$$E_{aQS} = E_{aMT} \pm e \quad (223)$$

Putting this value of E_{aQS} in equation (222) gives

$$\text{speed} = \frac{2f}{p} \sqrt{1 \pm \frac{e}{E_{aMT}}}$$

By changing the voltage e considerable variation in speed may be obtained. In practice, the speed cannot be reduced much below half synchronous speed on account of the resulting decrease in the flux φ_Q which varies with the speed. The torque developed by the motor is proportional to the product of the field flux φ_Q the current I_a and the phase angle between them. If the flux φ_Q is diminished much below one-half of its normal value, satisfactory operation cannot be obtained. Moreover, sparking will be likely to occur at the brushes bb since the speed voltage and the transformer voltage in the coils short-circuited during commutation by bb will not be equal. Commutation will be considered later. A resistance inserted in the brush circuit aa will have much the same effect on the speed as the voltage $-e$. The effect of this resistance, however, will not be so great as resistance put in the armature of a shunt motor. The drop in speed produced by resistance in the commutator-type induction motor enters in the equation for speed under a square-root sign.

Fig. 240 shows diagrammatically the method of obtaining the voltage to be inserted for varying the speed.

T is a transformer with secondary taps for varying the voltage e which is inserted in the brush circuit aa for varying the speed.

Method (b).—Any motor must speed up until its speed voltage plus the resistance and leakage-reactance drops in the armature equals the voltage acting in the armature circuit. Therefore, if the resistance and leakage-reactance drops are neglected,

$$E_{aMT} = E_{aQS} \quad (224)$$

$$KN\varphi_M f = KN\varphi_Q f(1 - s) \quad (225)$$

If, as in method (a), φ_Q is assumed to be proportional to the current I_b producing it, according to equation (219), page 538,

$$\varphi_Q = k'E_{bMS}$$

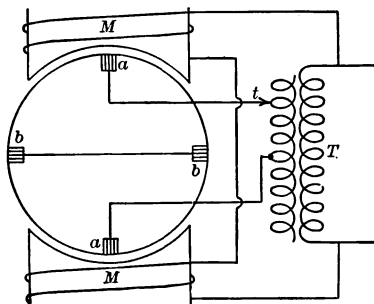

FIG. 240.

If a voltage e' in phase with or in opposition to E_{bMS} is inserted between the brushes bb ,

$$\begin{aligned} \varphi_Q &= k'(E_{bMS} \pm e') \\ E_{bMS} &= KN\varphi_M n = KN\varphi_M f(1 - s) \\ E_{aMT} &= KN\varphi_M f \end{aligned}$$

Therefore

$$E_{bMS} = E_{aMT}(1 - s)$$

and

$$\varphi_Q = k' \left\{ E_{aMT}(1 - s) \pm e' \right\} = k'E_{aMT} \left\{ (1 - s) \pm \frac{e'}{E_{aMT}} \right\} \quad (226)$$

At synchronous speed both e' and s must be zero and

$$\varphi_Q = k'E_{aMT}$$

As $\varphi_Q = \varphi_M$ at synchronous speed

$$k'E_{aMT} = \varphi_M$$

Substituting φ_M for the $k'E_{aMT}$ which is outside the brackets in equation (226) gives

$$\varphi_Q = \varphi_M \left\{ (1 - s) \pm \frac{e'}{E_{aMT}} \right\} \quad (227)$$

Substituting the value of φ_Q from equation (227) in equation (225) gives

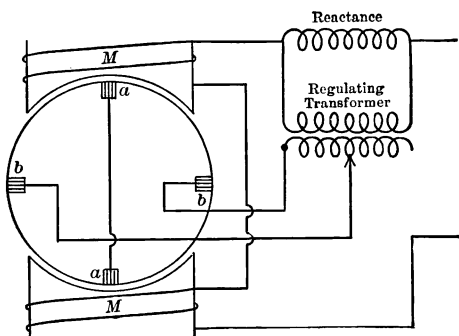

FIG. 241.

$$KN\varphi_M f = KNf(1 - s)\varphi_M \left\{ (1 - s) \pm \frac{e'}{E_{aMT}} \right\}$$

$$1 = (1 - s)^2 \pm \frac{e'}{E_{aMT}}(1 - s)$$

$$(1 - s) = \sqrt{1 + \left(\frac{e'}{2E_{aMT}}\right)^2} - \left(\pm \frac{e'}{2E_{aMT}}\right)$$

$$\text{speed} = \frac{2f}{p} \left\{ \sqrt{1 + \left(\frac{e'}{2E_{aMT}}\right)^2} - \left(\pm \frac{e'}{2E_{aMT}}\right) \right\} \quad (228)$$

This equation is merely approximate since it neglects the armature drops and assumes the flux φ_Q proportional to the current producing it. According to equation (228), $\frac{e'}{E_{aMT}}$ must equal $+\frac{3}{2}$ to halve the speed and to double the speed, it would have to be equal to $-\frac{3}{2}$.

Instead of inserting voltage in the brush circuit bb , resistance

may be inserted. This will increase the speed of the motor but it will also decrease the power factor.

Except for small changes in speed, method *b* is unsatisfactory. If any great change in speed is produced, this method causes sparking at the power brushes *aa*.

The voltage *e'* inserted in the brush circuit *bb* may be obtained from a transformer connected in shunt around an impedance coil placed in series with the motor, Fig. 241.

Commutation of the Commutator-type, Single-phase, Induction Motor.—The alternating flux of the quadrature field of the single-phase induction motor induces a transformer voltage in the armature coils short-circuited by the power brushes *aa*. This voltage, unless neutralized, would produce large currents in the short-circuited coils and these currents would have to be interrupted when the coils moved from under the brushes. This would result in bad sparking. The stator field would produce a similar action in the coils short-circuited by the field brushes, *bb*. In the single-phase induction motor, fortunately, there is also a speed voltage induced in each of the short-circuited coils. The transformer and the speed voltages in the coils under the power brushes *aa* neutralize at all speeds. They neutralize in the coils under the field brushes *bb* at synchronous speed only. Due to the neutralization of these voltages, the single-phase commutator induction motor does not require any special devices to improve commutation, for example, such as the resistance leads used between the armature winding and commutator of a single-phase series motor.

Let E_{aT} be the transformer voltage and E_{aS} the speed voltage in the armature turns short-circuited by the power brushes *aa*. Also let E_{bT} and E_{bS} be the corresponding voltages in the armature turns short-circuited by the field brushes *bb*. Let N' be the number of turns in the short-circuited coils. Then

$$E_{aT} = K_1 N' \varphi_Q f \quad (229)$$

$$E_{aS} = K_1 N' \varphi_M n \quad (230)$$

and

$$E_{bT} = K_1 N' \varphi_M f \quad (231)$$

$$E_{bS} = K_1 N' \varphi_Q n \quad (232)$$

where K_1 is a constant, N' the number of short-circuited turns,

f the frequency and n the speed in revolutions per second multiplied by the number of pairs of poles. Unless the two sets of brushes have the same width, N' will not be the same for both sets of brushes.

It has been shown that the fields φ_M and φ_Q are in space quadrature and very nearly in time quadrature. Applying the convention for determining the phase of a speed voltage will show that the two voltages induced by φ_M and φ_Q in each group of armature coils short-circuited by the brushes are opposite in phase.

For good commutation, the two voltages in the coils short-circuited by the brushes during commutation should be equal. They are in time-phase opposition. Therefore, for good commutation, the following relations should hold. For the brushes aa ,

$$\begin{aligned} E_{aT} &= E_{aS} \\ K_1 N' \varphi_Q f &= K_1 N' \varphi_M n \\ \frac{f}{n} &= \frac{\varphi_M}{\varphi_Q} \end{aligned} \quad (233)$$

For the brushes bb ,

$$\begin{aligned} E_{bT} &= E_{bS} \\ K_1 N' \varphi_M f &= K_1 N' \varphi_Q n \\ \frac{f}{n} &= \frac{\varphi_Q}{\varphi_M} \end{aligned} \quad (234)$$

At synchronous speed, φ_M and φ_Q are equal. Therefore, at synchronous speed equations (233) and (234) are fulfilled, since at this speed f and n are equal. As the single-phase induction motor operates under normal conditions with small slip, equations (233) and (234) are nearly fulfilled under normal operating conditions, and under these conditions there will be little trouble from sparking at either set of brushes.

Consider the effect on commutation of varying the speed by method (a), *i.e.*, by inserting voltage in the brush circuit aa . The field φ_Q , neglecting saturation, is proportional to I_b and consequently proportional to E_{bMS} . Since $E_{bMS} = KN\varphi_M n$,

$$\varphi_Q = K_2 \varphi_M n$$

where K_2 is a constant.

Since φ_M is nearly constant, φ_Q and n vary nearly in proportion so long as magnetic saturation of the circuit for φ_Q is not reached,

The condition, $\frac{f}{n} = \frac{\varphi_M}{\varphi_Q}$, for good commutation at the brushes *aa* is, therefore, fulfilled.

The condition, $\frac{f}{n} = \frac{\varphi_Q}{\varphi_M}$, for good commutation at the brushes *bb* is obviously not fulfilled. This is not very serious, provided the change in speed is not too great, since these brushes carry only the small current for the quadrature field φ_Q . Good commutation may be obtained by using, if necessary, narrow, high-resistance brushes.

Consider the effect on commutation of varying the speed by method (*b*).

From equations (224) and (225), page 240,

$$E_{aMT} = KN\varphi_Q f(1 - s)$$

E_{aMT} is nearly constant. If the speed is varied by changing φ_Q , $(1 - s)$ and, therefore, the speed must vary inversely as φ_Q . Under this condition it is obvious from equations (233) and (234) that good commutation is maintained at the field brushes *bb*, but not at the power brushes *aa*. The brushes *aa* carry the power current for the motor and sparking here is most serious. For this reason, method (*b*) for varying the speed is unsatisfactory and cannot be used except for small variations in speed.

CHAPTER LVI

METHODS OF STARTING SINGLE-PHASE INDUCTION MOTORS

Methods of Starting Single-phase Induction Motors.—Single-phase induction motors have no starting torque and require some form of auxiliary starting device to bring them up to such a speed that the torque developed is sufficient to overcome the counter-torque of their losses and the load. The methods of starting single-phase induction motors may be grouped under four general heads, namely:

(a) By some mechanical device.

(b) By the creation of a rotating field by the use of an auxiliary winding. This is the so-called "split-phase" method of starting. For small motors it is the most common of the four.

(c) By phase converter.

(d) By making use of the principle of the repulsion motor, employing a rotor with a winding and a commutator similar to that of a direct-current motor. This is used when large starting torque is required.

Method (a).—As may be seen from the speed-torque curve of the single-phase induction motor, Fig. 229, page 513, the torque developed increases rapidly with the speed. If a rotation be given to the armature by any mechanical means, such as by hand with very small motors or by a direct-current motor or other means in the case of larger motors, the motor may be made to develop sufficient torque to bring itself up to speed. This method of starting single-phase induction motors is obviously of little practical importance.

Method (b).—This method makes use of an auxiliary winding to create a revolving field. This winding, which may or may not be cut out after speed has been attained, is displaced in space from the main winding and carries a current which is displaced in time phase from the current in the main winding. This time phase displacement is secured by the use of resist-

ance or of reactance, or of both. The resistance and reactance are always cut out when the motor has reached its operating speed, even if the starting winding is left connected. A few of the more important arrangements for obtaining a revolving magnetic field for starting purposes follow.

One of the simplest methods is due to Tesla. This is shown in diagrammatic form in Fig. 242.

M is the main field winding. Q is an auxiliary winding which is placed in the stator slots but with its magnetic axis 90 space degrees from the magnetic axis of the main stator winding, M . A squirrel-cage armature is used. For starting, both windings are connected in parallel to the line, the main

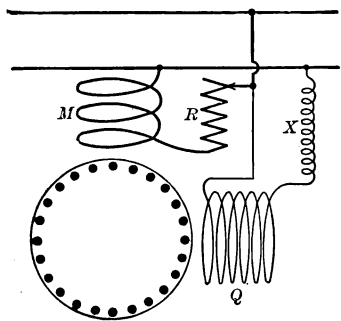

FIG. 242.

winding, M , through a non-inductive resistance, R , the auxiliary winding, Q , through a reactance, X . By this arrangement the currents in the two windings are displaced in time phase by a large angle and a revolving magnetic field results. Although far from constant in magnitude, this field is sufficient to bring the motor up to speed if the load be small. One object of the resistance R is to decrease the starting current. When the motor approaches its normal speed, this resistance and the auxiliary winding are cut out by some automatic centrifugal device mounted on the shaft of the motor. The arrangement just described is equivalent to a two-phase motor. In practice it is impossible to get a phase displacement of nearly 90 degrees by a split-phase device and, hence, for a single-phase induction motor using such a starting device the starting torque is small and the starting current correspondingly large.

The main winding of any single-phase induction motor usually has a phase spread of about $\frac{2}{3}$ or 120 degrees, and is equivalent to two phases of a three-phase motor connected in series. The auxiliary winding may be placed in the free third of the stator. If the auxiliary winding is disconnected after starting, it may be wound with wire of smaller size than the main winding and

The main winding of any single-phase induction motor usually has a phase spread of about $\frac{2}{3}$ or 120 degrees, and is equivalent to two phases of a three-phase motor connected in series. The auxiliary winding may be placed in the free third of the stator. If the auxiliary winding is disconnected after starting, it may be wound with wire of smaller size than the main winding and

with a greater number of turns. In most cases, however, a regular three-phase winding is used. For starting, two of the phases are connected in series, one of these phases being reversed, and these two constitute the auxiliary winding. The third phase constitutes the main winding. When the motor has reached its speed, the three windings are grouped to form an ordinary delta connection and the single-phase mains are connected to any two of the three terminals. The starting and running connections are shown in Figs. 243 and 244.

Reversing the connections of phase II for starting puts the two fields produced by the starting connections in space quadra-

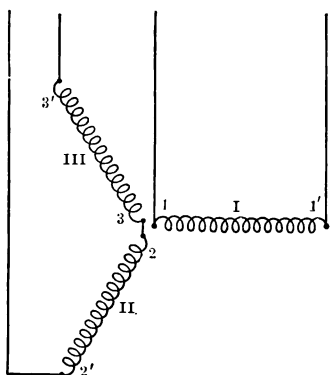

FIG. 243.

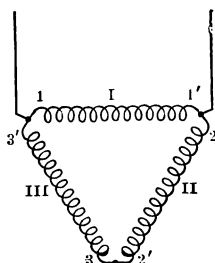

FIG. 244.

ture. The time phase displacement of the currents is obtained by the method indicated in Fig. 242.

The required phase displacement may be obtained by the use of a regular three-phase Δ - or Y -connected stator in conjunction with a reactance and a non-inductive resistance connected in series and then shunted across the line. Two of the terminals of the three-phase winding are connected to the single-phase mains. The third terminal is connected to the common junction between the resistance and reactance. The connections are indicated in Fig. 245. The resistance and reactance are cut out automatically by a centrifugal governor when the motor is up to speed. This arrangement is quite often used for small motors. It is objectionable for large motors

on account of the large starting current. The starting current may be diminished by using a Δ -connected motor, connected in Y for starting.

A simpler arrangement which avoids the necessity for changing the stator connections is shown in Fig. 246. In this arrangement while starting there is in series with the motor a resistance and reactance in parallel with each other. The arrangement shown in Fig. 245 puts the motor directly across the mains. The resistance and reactance in series are also connected across the mains.

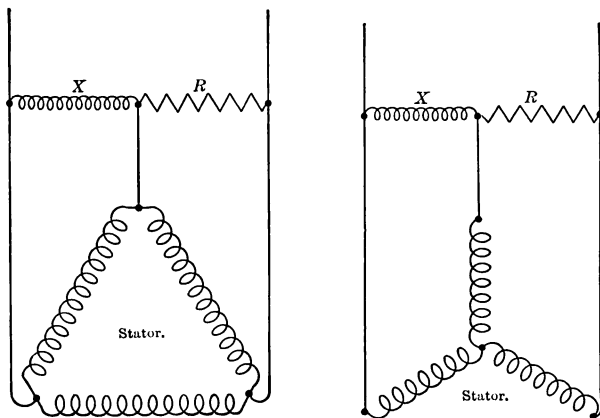

FIG. 245.

The starting torque obtained by the arrangements shown in Fig. 245 or Fig. 246 is small. The starting current is large. From two to three times full-load current is usually required to produce a starting torque of from 30 to 40 per cent. of full-load torque.

The starting torque may be very much increased by the use of a clutch which slips until about 80 per cent. of full speed has been attained. Such a clutch usually forms an integral part of the motor. By the use of a slipping clutch nearly full-load torque may be obtained at starting with only about full-load current.

Resistance and capacity might be used in place of resistance and inductance for starting a single-phase motor. The size

and cost of the condenser required to produce the necessary phase displacement prevent the use of capacity for this purpose.

For small motors, such as fan motors, the phase displacement may be obtained by the use of so-called shading coils. This is the simplest method for obtaining the required quadrature flux for starting. For this purpose the stator is constructed with laminated salient poles. About one-half of the face of each pole is surrounded by a low-resistance short-circuited winding. The arrangement of a four-pole motor of this type is indicated in Fig. 247.

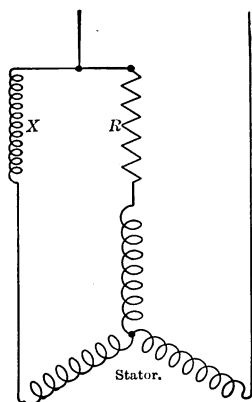

FIG. 246.

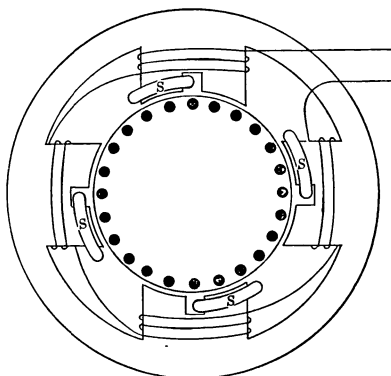

FIG. 247.

The short-circuited shading coils are shown as *S*. The effect of the currents induced in the short-circuited shading coils is to oppose the change in the flux produced by the main stator winding in the half of the poles they surround. The result is that the flux rises to a maximum in the unshaded portions before it reaches its maximum in the shaded portions of the field. The effect is a progressive shift in the field from the unshaded to the shaded portions of the poles. The armature will rotate in the same direction as the shift in the field. The shading coils are left in circuit after the motor has reached speed as the loss in them is small and of no importance in the small motors for which this method of starting is used.

Method (c):—A polyphase induction motor may be used as a phase converter to furnish polyphase power to other motors for

starting them from a single-phase line. The polyphase motor which is used as the phase converter must be brought up to speed by some one of the methods just described. This method of starting single-phase motors has limited application. It will be better understood after the phase converter has been explained.

Method (d).—The best method for starting single-phase induction motors, when large starting torque is required without excessive current, is by the use of the repulsion-motor principle. This method is due to E. Arnold. Motors which are started in this way have drum-wound armatures with commutators and are provided with brushes short-circuiting the armature along its electrical diameter. The axis of these brushes is slightly displaced from the axis of the stator winding.¹ A motor making use of this device comes up to speed as a repulsion motor. When the slip is about 10 per cent., a centrifugal device forces a ring against the back of the commutator thus short-circuiting each coil of the armature winding. The motor then runs as a single-phase induction motor. The brushes are lifted from the commutator when the armature is short-circuited. Such motors are usually started with resistance in series with the stator and are capable of developing large torque while coming up to speed without drawing excessive current from the mains. All single-phase commutator induction motors make use of the repulsion-motor principle in starting. With such motors, the armature is not short-circuited and the brushes are not lifted when operating speed is reached. To get starting torque, the brushes are rotated through a slight angle from their position along the axis of the field. They are usually left in this position even after the motor is up to speed.

¹“Series and Repulsion Motors,” p. 571.

CHAPTER LVII

THE INDUCTION MOTOR AS A PHASE CONVERTER

The Induction Motor as a Phase Converter.—An induction motor may be used as a phase converter, *i.e.*, to change the number of phases of a system. Except when the transformation is from or to single phase, it may be made much simpler, much more economically and with less unbalancing by the use of static transformers. When transformers are used for phase conversion, they produce no unbalancing with balanced loads provided their grouping is symmetrical. Even the unsymmetrical arrangements which are in common use, namely, the *T*- and *V*-connections, produce only slight unbalancing of voltages. The induction motor when used as a phase converter always produces some unbalancing of voltages and currents and this unbalancing may be very large. In many cases where an induction motor would be used as a phase converter, for example, for producing the required phase displacement for starting single-phase motors, unbalancing is of small importance. In other cases where unbalancing is of importance, it is possible to partially correct for it by adding to some of the phases auxiliary voltages obtained from transformers.

The two cases where the induction phase converter is of real use are for the conversion from single-phase to polyphase power and *vice versa*. Such conversion cannot be made by transformers. A recent application of phase conversion is in the operation of electric locomotives using three-phase induction motors. Three-phase induction motors are specially suitable for operating locomotives on long heavy grades. The installation of a phase converter on a locomotive having three-phase induction motors makes it possible to operate the locomotive from a single trolley. This gives the simplicity of single-phase line construction combined with the advantages gained by the use of polyphase induction motors for the motive power. Not the least among these advantages are electric braking and power regeneration on down grades.

Any induction motor which has a symmetrical polyphase winding and is operated from a line with balanced voltages develops a revolving magnetic field approximately constant in magnitude and rotating at nearly constant speed. It is obvious that if this motor have a second winding with a different number of phases, balanced polyphase voltages will be induced in this second winding by the revolving magnetic field. A second or independent winding is not necessary provided suitable taps are brought out from the main winding. Such a device could be used to transform from polyphase to single phase without much unbalancing of the polyphase system.

In a single-phase system the power is zero at least twice during each cycle. The power supplied to the polyphase side of a phase converter transforming polyphase to single phase must likewise fall to zero at least twice during each cycle unless there is some means of storing up kinetic energy in the moving part of the system. This energy would be stored during times of minimum output on the single-phase side and given out at other times. A slight variation in the angular velocity of the rotor during each cycle supplies the means of storing up and giving out this energy. When the demand for energy on the single-phase side is below its average value for a cycle, the rotor is accelerating and storing up kinetic energy. When the demand is above the average value, the rotor is retarding and giving up its kinetic energy.

The phase converter may also be used to transform from single phase to polyphase, but in this case there must of necessity be more or less unbalancing of the polyphase voltages due to the change in the quadrature field with load and to the impedance drops in the windings of the converter. Since one phase of the converter acts as a motor while the others act as a generator, the impedance drops cannot produce the same effect in the terminal voltage of each phase.

It has been shown that a single-phase induction motor develops a quadrature field which, combined with the stator field, produces a rotating magnetic field. This rotating field is constant in magnitude at synchronous speed except for the leakage-reactance and resistance drops in the rotor windings. Below synchronous speed the magnitude of the rotating field varies during a cycle, due to the decrease in the quadrature field produced by the slip.

In order to make this decrease small, the rotor resistance, which determines the slip should be made as small as practicable. To minimize the effect of the impedance drops on the unbalancing of the terminal voltages, these drops should also be made as small as possible. For best balance of voltages, it is necessary to design a phase converter for minimum leakage-reactance and resistance drops in both the stator and the rotor. Low rotor resistance is essential since it not only affects the rotor voltage

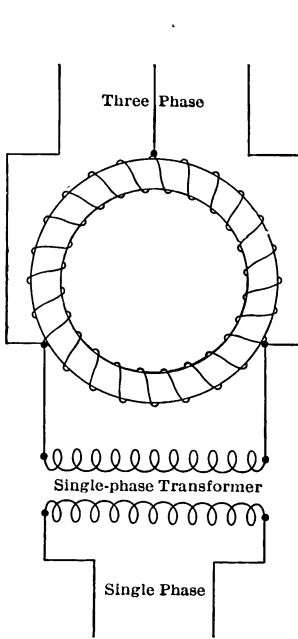

FIG. 248.

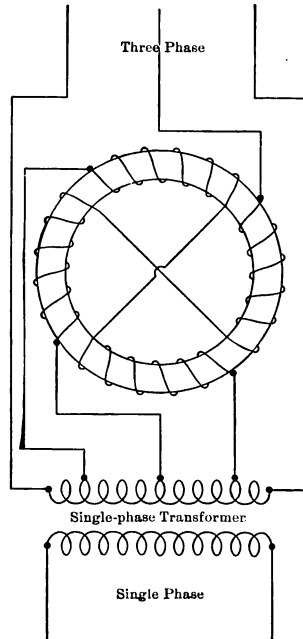

FIG. 249.

drops but, through its effect on the slip, decreases the magnitude of the quadrature field.

When a given amount of power is to be changed from one number of phases to another, the most economical arrangement is that which requires the least actual transformation. If single-phase power is to be transformed to three-phase, the power for two of the phases must be transformed from the initial single phase by the converter. Two-thirds of the total power for the

three-phase system must be transformed. The other third comes directly without transformation from the single-phase line supplying the converter. The capacity of the converter, therefore, must be two-thirds as great as the amount of polyphase power delivered. If the transformation is made from single phase to two phase, only half the power on the two-phase side is obtained by actual transformation and the capacity need be only half as great as the two-phase power delivered. If three-phase power is desired from single phase, a two-phase converter may be used, the transformed phase from the converter taking the place of the teaser in a *T*-connection, where the line or the single-phase transformer feeding the converter forms the main transformer. This arrangement has the advantage of requiring the least converter capacity for a given amount of three-phase power delivered. The connections for the two arrangements for transformation from single phase to three phase are shown in Figs. 248 and 249. The stator windings are shown as ring windings merely to simplify the diagrams. Special devices must be used for keeping the voltages balanced under varying load.

SERIES AND REPULSION MOTORS

CHAPTER LVIII

TYPES OF SINGLE-PHASE COMMUTATOR MOTORS WITH SERIES CHARACTERISTICS; STARTING; DOUBLY FED MOTORS; DIAGRAMS OF CONNECTIONS FOR SINGLY AND DOUBLY FED SERIES AND REPULSION MOTORS; POWER-FACTOR COMPENSATION

Types of Single-phase Commutator Motors with Series Characteristics.—Single-phase commutator motors with series characteristics may be divided into two general classes:

- (a) Series motors.
- (b) Repulsion motors.

The chief distinction between these two types is in the way the armature receives power. The armature current of series motors is obtained by conduction from the line. The armature current of repulsion motors is obtained by induction from a winding on the stator.

For speeds greater than zero and less than about 1.4 synchronous speed, the commutation of repulsion motors is inherently better than of series motors. In other respects the operating characteristics of the two types are similar. Both types require three windings or their equivalent.

1. An exciting winding for producing the exciting or torque-producing field, *i.e.*, the field which produces torque in conjunction with the armature current.
2. An energy or armature winding for producing motor power.
3. A compensating winding which compensates for the armature reaction.

In some types of motors, as for example the simple repulsion motor, one winding may be made to serve as compensating winding and exciting winding as well. On account of the way in which the armatures of the two types of motors receive current, the motors might be called Conductive Series Motors and

Inductive Series Motors. There are many modifications of the two general types of motors having series characteristics.

Starting.—Series and repulsion motors may be started with resistance in series like any direct-current series motor, but when variable speed is desired, it is customary to start motors of any appreciable size on reduced voltage obtained from a transformer or a compensator. This transformer or compensator may also be used to vary the speed by changing the impressed voltage.

Doubly Fed Motors.—In addition to the simple or singly fed series and repulsion motors, there is another class known as doubly fed motors. Some forms of this latter class are sometimes called series-repulsion motors. Doubly fed motors may be either of the series or the repulsion type. The armature of a motor of the doubly fed type receives power by induction from a winding on the stator and in addition receives power by conduction from the line. The power from the line is obtained from a transformer connected across the mains from which the motor is operated and this transformer serves for starting and also for varying the speed of the motor. Doubly fed motors may be given better commutation characteristics over a wider range of speed than motors of the singly fed type. In general, they have better operating characteristics above synchronous speed than singly fed motors.

The simple repulsion motor operates best at speeds below synchronous speed while the doubly fed repulsion motor operates best at speeds above synchronous speed. By proper switching arrangements, a motor may be started with the connections which give best commutation, power factor and torque when starting and may be operated with the connections best adapted to the load conditions. For example, a motor may be started as a simple repulsion motor and on reaching synchronous speed may be converted into a doubly fed series or repulsion motor for operation at speeds above synchronism. By properly changing the motor circuit connections it is possible to make certain types of doubly fed motors regenerate for braking purposes in electric railroad work.

Diagrams of Connections for Singly and Doubly Fed Series and Repulsion Motors.—The connections for a simple or singly

fed series motor, a simple or singly fed repulsion motor, a doubly fed series motor and a doubly fed repulsion motor are shown in Figs. 250, 251, 252 and 253. In these figures

- S* = Series winding producing the torque field.
- C* = Compensating winding.
- A* = Armature.
- T* = Speed-regulating and starting transformer.

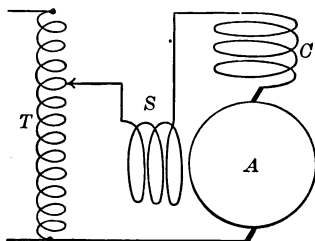

FIG. 250.

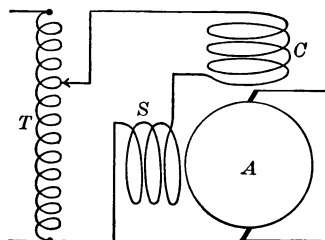

FIG. 251.

In the repulsion motor, a single distributed winding is made to serve for both the series and compensating windings shown in Figs. 251 and 253. This is accomplished by shifting the brush axis out of coincidence with the axis of the single winding. The magnetomotive force of this single stator winding may then be

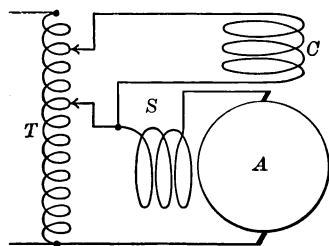

FIG. 252.

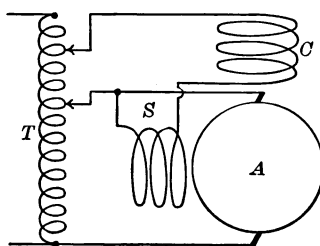

FIG. 253.

resolved into two component magnetomotive forces at right angles to each other, one along the brush axis the other at right angles to the brush axis. The first corresponds to the magnetomotive force of the compensating winding, the second to the magnetomotive force of the series winding. By changing the position of the brush axis with respect to the axis of the

stator winding, the speed and the other operating characteristics of the motor may be changed. The direction of rotation is determined by the direction in which the brushes are displaced from the axis of the stator winding.

To serve its purpose of neutralizing armature reaction, the compensating winding of a series or repulsion motor must always be distributed, since the magnetomotive force of a distributed armature winding can be neutralized only by a similarly distributed compensating winding.

Power-factor Compensation.—In addition to compensating for armature reaction, it is possible by the addition of extra brushes to compensate for the reactance of the exciting winding and thus to make a repulsion motor operate at unity power factor for some particular load and speed. The principle underlying this compensation is much the same as that for power-factor compensation in the single-phase induction motor.

CHAPTER LIX

SINGLY FED SERIES MOTOR; VECTOR DIAGRAM; APPROXIMATE VECTOR DIAGRAM; OVER- AND UNDER-COMPENSATION; STARTING AND SPEED CONTROL; COMMUTATION; INTER-POLES; CONSTRUCTION, EFFICIENCY AND LOSSES OF SERIES MOTORS

Singly Fed Series Motor.—Since the current in the armature and in the field of the series motor reverses at the same time, any direct-current series motor would develop torque if supplied with alternating current. Owing to the high inductance of the field and armature windings of such a motor, as well as to the large iron losses, little torque or power would be developed and the power factor would be very low. Destructive sparking would also occur due to the transformer action in the armature coils short-circuited by the brushes during commutation.

The torque developed by any motor is proportional to the product of the armature current and the component of the air-gap flux which is in time phase with that current. In a series motor, the flux is very nearly in time phase with the current. Any required torque may be obtained by using either a strong field and few armature turns, or by using a weak field and many armature turns. In other words, the ratio of armature turns to field turns may be either large or small. In order to minimize the effect of armature reaction and to reduce the cost of construction, the usual design of a direct-current series motor calls for a strong field and a relatively weak armature. If the motor is to operate on alternating current, the design calls for a weak field and a relatively strong armature.

The reactance of a coil varies as the square of the number of turns. By using a weak field and strong armature, *i.e.*, a field of few turns and an armature of many turns, the field reactance may be very much reduced. This reduction, however, necessitates a corresponding increase in the armature ampere-turns and consequently in the armature reactance. Nothing would be

gained by using a weak field and a strong armature were it not possible to compensate for the armature reactance caused by the cross-flux produced by the armature current.

The reactance drop in a series motor depends on f , N_f^2 and N_a^2 , where f is the frequency, N_f the field turns and N_a the armature turns. In order to make the reactance small, the frequency must be low. Except in very small sizes the design of a satisfactory 60-cycle series motor is not practicable. On account of commutation difficulties, the series motor is essentially a low-voltage motor. If the voltage were to be doubled, the turns of all windings would also be doubled. The reactance would increase four times, while the current for the same output would be halved. The percentage reactance drop would remain unchanged. The reactance, therefore, is not the factor which limits the voltage to low values. The voltages for which alternating-current series motors are usually designed lie between 200 and 300. Except for very small motors, the frequency is never greater than 25 cycles. Abroad, frequencies as low as $12\frac{1}{2}$ and 15 cycles are used.

The internal power developed by a motor is equal to the product of its armature current and the component of the armature electromotive force of rotation in phase with it. In the series motor, the electromotive force of rotation is in time phase with the flux, since it is produced by the rotation of the armature inductors in the alternating field and not by the transformer action of the field on the armature winding. Since the speed is constant for any given load, the electromotive force will be directly proportional to the flux. Whenever the flux is a maximum, the electromotive force will be a maximum. For given current, the power developed is proportional to the electromotive force of rotation. This electromotive force is equal to the total voltage impressed on the motor less the total impedance drop in both armature and field windings. If the total reactance is large, the electromotive force of rotation will be small and little power will be developed. The power factor will also be low.

$$E_a = K \times \text{speed} \times \varphi \times N_a$$

where E_a , K , φ and N_a are, respectively, the electromotive force of rotation, a constant, the air-gap flux and the armature turns.

To increase the flux, φ , requires an increase in the number of turns on the field and hence an increase in field reactance. Increasing N_a increases the armature reactance. The armature reactance is due to the flux set up by armature reaction. This flux acts along the brush axis and at right angles to the axis of the main field provided the brushes are set in the neutral plane. It serves no useful purpose and may be suppressed without affecting the torque developed by the motor. The reactance of the main field cannot be compensated without destroying the field flux and, therefore, the motor torque.

It is necessary to design an alternating-current series motor with few field turns and many armature turns and then to eliminate the cross-field due to the armature reaction by a suitable compensating winding surrounding the armature. This compensating winding is placed with its magnetic axis parallel to the magnetic axis of the armature, must have the same number of effective turns as the armature and be connected so as to oppose the armature reaction. The compensating winding must be distributed in order to compensate for the reaction of the distributed armature winding. It is placed in slots in the pole faces. Since it is not practicable to carry the conductors into the space between the poles, perfect compensation is not possible. While the presence of an uncompensated zone between the poles is undesirable from the standpoint of commutation, the effect of this zone is not serious since the cross-flux produced therein by the armature conductors is small and the omission of the compensating winding from this zone will have relatively little effect either on the resultant reactance or the commutation of the motor.

Let E_a , N_a , N_f , x_a , x_f and f be, respectively, the voltage of rotation, the number of armature turns, the number of field turns, the armature reactance, the field reactance and the frequency.

$$E_a \text{ varies as } N_a \varphi$$

$$x_a \text{ varies as } N_a^2 f$$

$$x_f \text{ varies as } N_f^2 f$$

Lowering f will improve the power factor. N_a should be large with respect to N_f and the reactance drop due to the armature current in the N_a armature turns should be compensated for.

It is impossible to compensate for the leakage reactance. In order to get sufficient flux with few field turns, the air gap should be small, the field core should be massive and should be operated at relatively low flux density. Since the armature reaction is compensated, the presence of a small air gap is not objectionable except for mechanical reasons. The length of the magnetic circuit of a multipolar motor is necessarily shorter than that of a bipolar motor, and for the same total magnetomotive force a larger total flux can be obtained. Since the reactance of a circuit varies as the square of the number of turns, the field reactance

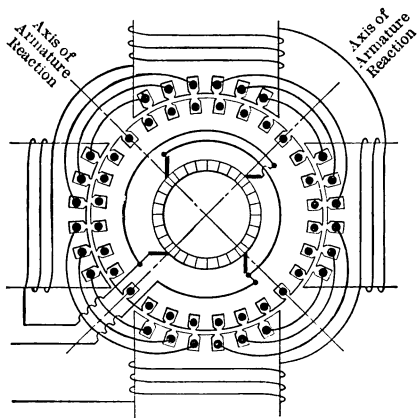

FIG. 254.

of a multipolar motor is less than the field reactance of a bipolar motor.

Fig. 254 shows the arrangement of conductors on the armature and compensating field of a four-pole motor. The compensating coils must be so connected that the current flows in the same direction in all of the conductors under any one pole. A developed field showing the compensating winding is given in Fig. 255. The compensating field may be connected in series with the armature, in which case the motor is said to be conductively compensated. It may be short-circuited on itself, in which case the motor is inductively compensated and the compensating winding acts like the secondary of a short-circuited transformer for which the armature winding is the primary. Conductive

compensation must obviously be used in all cases where a motor is to operate both on direct and alternating current.

Fig. 256 shows a portion of the stator of a large 25-cycle single-phase compensated series motor for mounting in the cab of an electric locomotive.

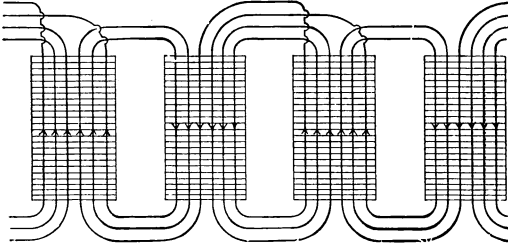

FIG. 255.

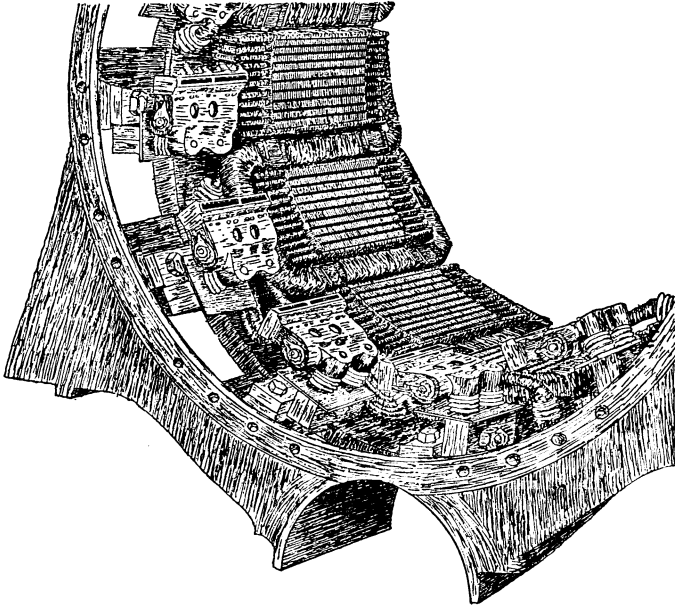

FIG. 256.

Vector Diagram.—The vector diagram of a singly fed series motor is given in Fig. 257.

The subscripts *f*, *a*, and *c* refer to the main field, the armature and the compensating field, respectively.

The current I , which is the same in all windings of the motor, is resolved with respect to the main field into a magnetizing component, I_φ , and a component, I_{h+e} , which supplies the iron losses caused by the field. Referring to Fig. 257, $I r_f$ is the drop in voltage due to the resistance of the main field winding. $I_\varphi x_f$, in quadrature with I_φ , is the actual reactance drop in the main field due to the flux φ . E_a is the voltage drop required to balance the voltage induced in the armature by rotation and is in time phase with the armature flux and with the current I_φ . The two small triangles at the right are the equivalent impedance drops in the armature and compensating fields, due to their effective resist-

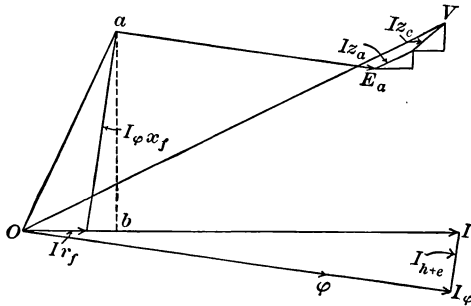

FIG. 257.

ances and effective leakage reactances. Perfect compensation is assumed, *i.e.*, complete neutralization of armature reaction by the compensating winding.

Approximate Vector Diagram.—The angle between the magnetizing component I_φ and the total field current I is small. In the approximate diagram this angle is assumed to be zero. According to this assumption the field flux φ and the voltage drop E_a are in time phase with the total field current I .

Replacing the real reactance and resistance drops by their equivalent values gives the approximate vector diagram shown in Fig. 258. The resistance drop and equivalent reactance drop in the series field are ob and ba , Figs. 257 and 258. The sum of these drops is equal to the voltage which would be found by a voltmeter placed across the main field winding, with the motor running.

Over- and Under-compensation.—The maximum power factor for any load will be obtained when the compensation for the cross-flux due to the armature current is perfect. Either over- or under-compensation will increase the resultant reactance drop in the armature and compensating field.

If the motor is over-compensated, the magnetomotive force of the compensating winding is greater than the magnetomotive force of the armature and their resultant magnetomotive force causes a flux in the same direction as the flux which would be produced by the compensating winding alone. Since this flux links with both the armature and the compensating winding and is 180 degrees from that which the armature alone would produce, the drop in the armature due to it lags behind the armature current by 90 degrees. The drop in the compensating winding

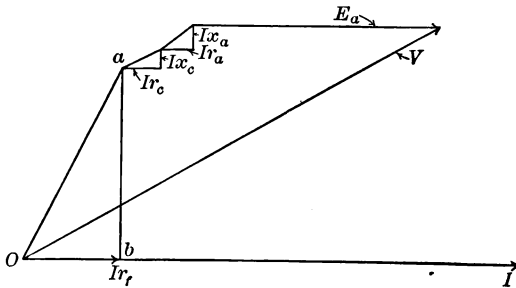

FIG. 258.

leads the current in that winding by 90 degrees. It will be larger than the drop in the armature, since for over-compensation the effective turns on the compensating field must be greater than the effective turns on the armature. The net drop due to both armature and compensating winding, therefore, leads the current by 90 degrees. If the motor is under-compensated, there is an unbalanced magnetomotive force which sends a flux in the opposite direction, *i.e.*, in the direction of the armature magnetomotive force. In this case the drop through the armature will be greater. The net drop due to the cross-flux caused by armature and compensating field windings is 90 degrees ahead of the current, whether the flux is caused by under- or over-compensation. Over-compensation cannot produce a capacity effect, increasing the power factor of the motor.

Starting and Speed Control.—An alternating-current series motor may be started, and its speed controlled, by means of series resistance, just as with the direct-current series motor. The reduction of voltage across its terminals for starting, and the variation in the impressed voltage for controlling its speed, may be more economically obtained by using taps on the transformer or compensator from which the motor receives power. The latter method on account of its greater economy is always employed for large motors.

Commutation.—The greatest difficulty in the design of an alternating-current series motor is due to the transformer voltage produced in the armature coils when short-circuited by the brushes during commutation. The armature coils which are short-circuited by the brushes link with the full flux from the field. They act like the short-circuited secondary of a transformer for which the field coils of the motor are the primary. Large currents causing excessive heating will be produced in these short-circuited armature coils. Since these currents must be interrupted when the coils move from under the brushes, bad sparking will occur. In addition to causing heating and excessive sparking, the transformer currents in the coils short-circuited by the brushes react on the field and thereby reduce the torque developed by the motor for a given current. They will also lower the power factor. In order to make the operation of a series motor commercially satisfactory, some means must be adopted for reducing these short-circuit currents. They are most troublesome during starting when the field flux is usually greater than under normal running conditions. The time during which any armature coil remains short-circuited is also a maximum during starting.

The most common way of reducing sparking, caused by the interruption of the transformer current in the coils short-circuited by the brushes, is to diminish this current by the insertion of resistance leads between the commutator bars and the armature winding, Fig. 259. Two of these resistance leads are in series with respect to the short-circuited coil while with respect to the external circuit, two are in parallel.

Although these resistance leads increase the armature resistance as measured between brushes, they actually diminish the

total copper loss in the armature on account of the very large decrease they produce in the copper loss in the short-circuited coils. The efficiency of the motor may be improved by their use, while by diminishing sparking they make the operation of the motor commercially possible. These resistance leads are usually of German silver and are laid in the bottom of the slots containing the armature coils. Increasing the number of commutator bars

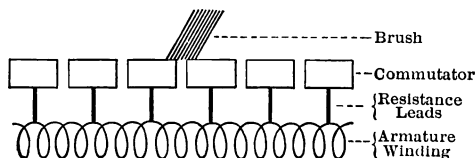

FIG. 259.

decreases the number of turns between adjacent bars and consequently decreases the transformer voltage in the short-circuited coils. The lower this voltage can be made, the smaller will be the resistance required in the resistance leads in order to reduce the current in the coils short-circuited during commutation to a permissible value. For this reason, series motors which are designed to operate on alternating-current circuits must have many

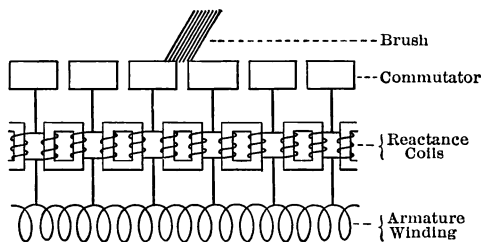

FIG. 260.

commutator bars and few turns between bars. This is also the reason why such motors are wound only for low voltages.

The chief difficulty involved in the use of resistance leads is to secure adequate space for them and to prevent their overheating and burning out. When a motor is running, any one resistance lead is in circuit only a relatively small part of the time. If only enough cooling surface is provided to keep the leads cool

under this condition, they are liable to burn out when the motor is at rest and carrying current, or when its armature is revolving at a slow speed as in starting. In spite of this difficulty, the use of resistance leads in the simple series motor is the most satisfactory method of reducing the current in the short-circuited coils to permissible values.

Inductances, arranged as shown in Fig. 260, will reduce the sparking, but are not used on account of the resulting complication and the space required.

The two sides of any one coil must be wound in the same directions as looked at from the same end in order that the magnetomotive forces produced in them shall neutralize for currents going to or coming from the external circuit and be in conjunction for the short-circuit current. Coils arranged as shown in Fig. 260 interpose a high reactance to the passage of the short-circuit current and a very small reactance to current taken by the motor from the external circuit.

Interpoles.—Interpoles connected in series with the armature are of no use in suppressing the commutation troubles due to the transformer action in the short-circuited coils. The flux produced by such interpoles is nearly in phase with the current. The voltage induced by the movement of the short-circuited armature coils through this flux will be in phase with the flux and nearly in phase with the current. The transformer voltage induced in the short-circuited armature coils by the main field is in quadrature with the current. These two quadrature voltages not only cannot neutralize each other, but must give a resultant voltage which is greater than either. Moreover, since one is proportional to frequency and independent of speed, and the other is proportional to speed and independent of frequency, they can be made to neutralize at only one speed even if they are brought into the correct phase relation, as they may be by the use of suitable connections.

Interpoles are sometimes used to aid commutation. Excited from a small auto-transformer shunted around the armature, the current they take, and their flux, will be approximately 90 degrees behind the flux of the main field. Under this condition the speed voltage induced by them in the short-circuited armature coils will be nearly in time phase opposition to the

voltage induced in the coils by the transformer action of the main field. The two voltages may be made to cancel for any given load and speed by properly adjusting the interpoles. The interpoles, however, can be effective only while the motor is running and cannot aid commutation during starting. In order to be effective at more than one speed and load, their strength must vary inversely as the speed and directly as the load current. This may be brought about by changing the voltage impressed on them by the auto-transformer. Interpoles are not in general use on series motors. In the doubly fed series motor the effect of interpoles is obtained from the compensating winding.

Construction, Efficiency and Losses of Series Motors.—Series motors for alternating-current operation must have both armature and field cores laminated. They must have large armatures with many inductors. The commutators must also be large in diameter in order to permit the use of a sufficient number of commutator bars between brushes to keep the voltage between adjacent bars low enough to insure good commutation with a minimum resistance in the commutating leads connecting the armature winding to the commutator bars. The pole cores are shallow, project only slightly from the frame and carry a field winding of comparatively few turns. Each pole core is slotted to receive the compensating winding which has many more turns and contains more copper than the main series winding. Series motors for alternating-current operation are in general heavier than direct-current series motors of the same output and speed. Their efficiency is somewhat lower than that of a corresponding direct-current motor chiefly due to the presence of certain losses which do not exist in the direct-current motor. The three principal extra losses are: stator core loss, commutation loss due to the transformer action of the main field on the armature coils while short-circuited and local core losses due to leakage flux. In addition, the copper loss of the motor is greater than that of a direct-current motor as the power factor is less than unity. Alternating-current series motors are operated two in series when used on 600-volt direct-current circuits, as when interurban cars having alternating-current series motors enter cities having a direct-current trolley system.

CHAPTER LX

SINGLY FED REPULSION MOTOR; MOTOR AT REST; MOTOR RUNNING; VECTOR DIAGRAM; COMMUTATION; COMPARISON OF THE SERIES AND REPULSION MOTORS

Singly Fed Repulsion Motor.—The connections for a conductively compensated singly fed series motor are shown in Fig. 261. *MM* is the main field winding and *CC* the compensating winding. The armature winding is not shown. In practice the compensating winding is placed in slots in the pole faces.

The connections for an inductively compensated series motor are shown in Fig. 262. The armature and compensating field

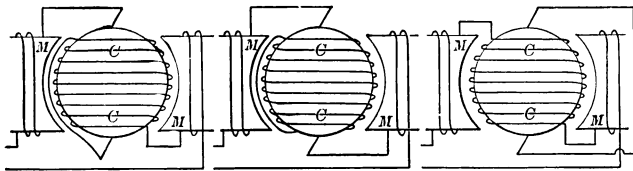

FIG. 261.

FIG. 262.

FIG. 263.

act as primary and secondary of a short-circuited transformer. The operation of the motor is the same as with conductive compensation, provided the magnetic circuit for the cross-field is sufficiently good to prevent large magnetic leakage between the compensating and the armature windings.

Instead of short-circuiting the compensating field, this field and the main field may be connected in series and the armature short-circuited. This scheme of connections is shown in Fig. 263. The current in the armature will now be obtained by induction. The motor will operate satisfactorily provided the magnetic circuit for the armature and compensating field is sufficiently good to permit satisfactory transformer action between them.

The connections shown in Fig. 263 are those of a repulsion

motor. The necessity for a good magnetic circuit both along the axis of the main field and also along the axis of the armature and the compensating field requires the use of non-salient poles and a uniform air gap. With non-salient poles both the main and compensating field windings must be distributed, being placed in slots in the stator. There is no particular object in using two independent windings for these two fields. In the simple repulsion motor, they are combined in a single uniformly distributed winding and the effect of two windings is obtained by displacing the brush axis from the axis of the single stator winding. The magnetomotive force of this single winding may then be resolved into two components, one along the brush axis, corresponding to the magnetomotive force of the compensating winding, the other at right angles to the brush axis and corresponding to the magnetomotive force of the main field winding.

The connections for a repulsion motor are shown diagrammatically in Fig. 264, salient poles being indicated merely for simplicity.

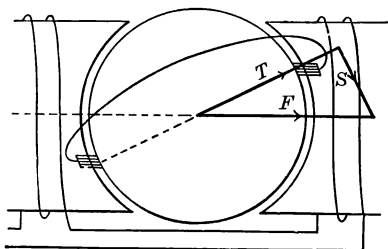

FIG. 264.

F represents the direction and magnitude of the magnetomotive force of the stator winding. This magnetomotive force is resolved into two components, T and S . The component T , along the brush axis, corresponds to the compensating field and produces current in the armature by transformer action. It will be called the transformer field. The component S , at right angles to the brush axis, corresponds to the main field of Fig. 263. It produces torque in conjunction with the current induced in the armature by the component T . It cannot, however, produce any voltage between the brushes by transformer action. When the armature revolves, a speed voltage is induced in the armature between the brushes by the field S . The field S will, therefore, be called the speed field. It may also be called the torque field, since it produces torque in conjunction with the armature current. The voltage induced in the armature by the field S is the back electromotive force of the motor.

The relative magnitude of the two component fields is determined by the position of the brush axis with respect to the axis of the stator winding. Increasing the displacement of the brush axis from the axis of the stator field decreases the transformer field and increases the speed field and causes the motor to slow down. Reversing the direction of the displacement of the brushes reverses the transformer field T without changing the direction of the speed field S with respect to the armature. Hence, it reverses the direction of rotation of the motor. The characteristics of the motor as well as its direction of rotation depend upon the position of the brush axis.

The speed of the repulsion motor may be varied by changing the impressed voltage, as in the series motor, or by changing the position of the brush axis. In the doubly fed repulsion motor, in addition to the methods just stated, the speed may be changed by varying the voltage inserted in the armature circuit.

The series motor with either conductive or inductive compensation has no field along the brush axis, since the magnetomotive forces of the armature and of the compensating field neutralize along this axis. Except at starting, the repulsion motor has a strong field along the brush axis. This is the essential difference between the two types of motor and is the cause of the chief difference in their operating characteristics.

The armature current of the repulsion motor results from transformer action between the armature and the component of the stator magnetomotive force which lies along the brush axis. The load on this equivalent transformer is equal to the armature current multiplied by the back electromotive force generated in the armature by its rotation in the speed field. Neglecting the magnetizing current in the stator winding for the transformer field, the armature current is proportional to the stator current and, therefore, to the current producing the speed field. Hence the repulsion motor has the torque and speed characteristics of a series motor. It differs materially from the series motor in commutation, however. This difference is due to the transformer field, which induces a speed voltage in the armature coils short-circuited by the brushes and neutralizes at synchronous speed the transformer voltage produced in those coils by the speed field. The conditions are similar to those existing at the brushes aa

in the single-phase commutator-type induction motor, Fig. 237, page 533.

Motor at Rest.—In discussing the repulsion motor, the two component fields will be replaced by two separate fields in space quadrature: one the torque-producing or speed field SS , the other the current-producing or transformer field TT , Fig. 265. The short-circuited armature brushes are shown as aa .

With the motor at rest, the component field TT in conjunction with the armature forms a short-circuited transformer. The voltage across TT is the equivalent impedance drop of this transformer.

The flux φ_S due to SS cannot produce any transformer voltage in the armature between the brushes since the axis of SS is perpendicular to the brush axis. The total voltage impressed across the motor will be the vector sum of the impedance drops due to the component field SS and to the short-circuited transformer formed by the component field TT and the armature. The conditions are equivalent to a short-circuited transformer in series with an impedance coil.

Since there cannot be any mutual induction between the field SS and the armature, the reactance of the field SS will be high. The power absorbed by it will be merely the copper loss in the winding and the core loss due to the flux φ_S . The resistance drop should be small compared with the total reactance drop. Consequently the magnetizing current and the flux φ_S of the field SS will be nearly in time phase with the current taken by the motor. Since the component field TT and the armature act together like a short-circuited transformer, the current I_a in the armature must be very nearly opposite in time phase to the current in the field TT . Therefore, the armature current I_a and the flux φ_S must be nearly in time phase opposition, and since the brush axis is at right angles to the axis of the flux φ_S , torque will be developed and the motor will speed up. At starting, nearly all the drop in voltage through the motor is in the component field SS . Changing the brush position alters the relative

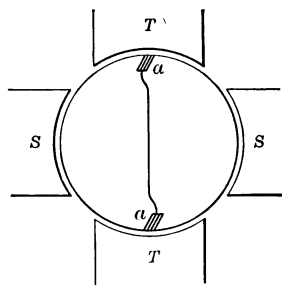

FIG. 265.

number of ampere-turns in the two component fields SS and TT . The further the brush axis is moved from the axis of the stator winding, the greater will be the field SS and the smaller will be the field TT . For a given current, this will increase the voltage drop across the motor at the instant of starting.

Motor Running.—When the motor speeds up, a speed voltage, E_S , is produced across the brushes aa by the rotation of the armature in the component field SS . This voltage corresponds to the back electromotive force of the series motor. It will be in time phase with the flux φ_S and since the stator current and φ_S are nearly in time phase, this voltage will be nearly in time phase with the stator current. Neglecting the exciting current for the transformer formed by the stator winding and the armature, the armature current I_a is in time opposition to the stator current. Therefore, E_S will be nearly in time phase opposition to the armature current. Hence the load on the transformer formed by TT and the armature will be nearly non-inductive. The armature current I_a is due to the resultant of the transformer voltage E_T and the speed voltage E_S , acting on the armature leakage impedance $z_a = r_a + jx_a$, where x_a is the leakage reactance.

$$I_a = \frac{E_T + E_S}{r_a + jx_a} = \frac{E_a}{r_a + jx_a} \quad (235)$$

This current will lag behind the resultant voltage E_a by an angle whose tangent is $\frac{x_a}{r_a}$.

The motor under load is equivalent to a loaded transformer in series with an impedance coil. The poles TT with the armature form the transformer. The poles SS with their winding form the impedance coil.

Vector Diagram.—The load conditions will be made clearer by a time phase vector diagram, Fig. 266. To simplify this diagram the flux φ_S is assumed in phase with the current taken by the motor. The ratio of transformation between TT and the armature is taken as unity.

Referring to Fig. 266, φ_S is the flux produced by that component of the magnetomotive force of the stator winding which corresponds to the winding on the poles SS , Fig. 266a. The flux φ_S is assumed to be in phase with the current I taken by the motor. The other component of the stator magnetomotive

force, *i.e.*, that corresponding to the magnetomotive force of the poles *TT*, divides into three components. Instead of dividing the magnetomotive force into three components, the current *I* carried by the field winding on *TT* may be so divided. These components correspond to those into which the primary current of any static transformer may be conveniently resolved. They are a magnetizing component, $I_{\varphi T}$, for the flux, φ_T , a component,

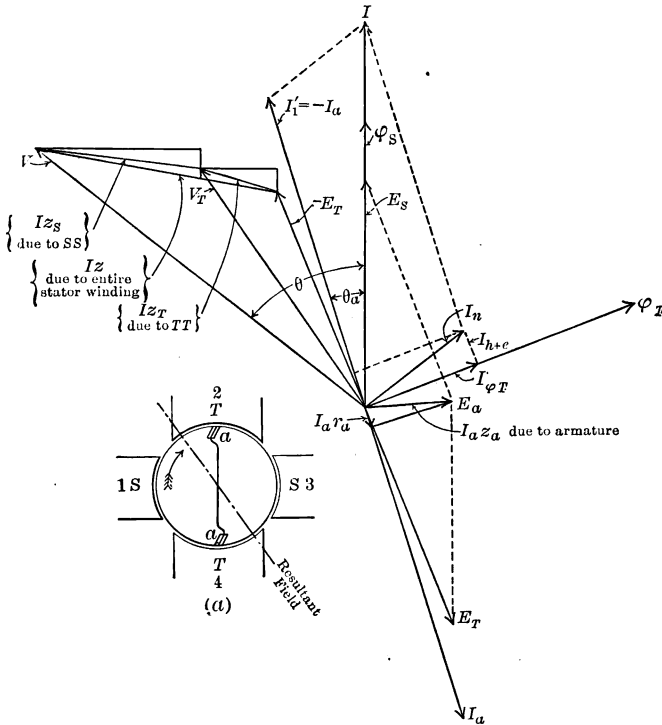

FIG. 266.

I_{h+e} , supplying the core loss due to φ_T and a load component, I_1 , which balances the demagnetizing action of the armature current.

The flux φ_T induces in the armature a transformer voltage, E_T , in time quadrature with φ_T . This corresponds to the voltage induced by the mutual flux in the secondary winding of a transformer. E_S is the speed voltage induced in the armature by the

field φ_S . This voltage corresponds to the voltage rise through the load on a transformer. The vector sum of E_T and E_S is the resultant voltage E_a , which causes the current to flow through the armature leakage impedance.

The vector sum of $-E_T$ and the impedance drop due to I in field TT gives the drop in voltage, V_T , across the field TT . V_T added to the impedance drop in the field SS gives the voltage drop, V , impressed across the stator.

The actual repulsion motor has a single stator winding instead of the two shown in Fig. 266*a*. To make the vector diagram correspond to the actual motor it is necessary to combine the two drops Iz_S and Iz_T into a single impedance drop $Iz = I(r + jx)$, where r is the effective resistance of the whole stator winding and x is the leakage reactance of the whole stator winding plus the stator reactance due to the flux φ_S . The resistance r should include the effect of the local losses due to the leakage flux of the stator, and also the core loss due to the flux φ_S .

$$\begin{aligned} \text{Power factor} &= \cos \theta \\ \text{Power input} &= VI \cos \theta \\ \text{Internal power} &= E_S I_a \cos \theta_a \\ \text{Torque} &= k I_a \varphi_S \cos \theta_a \end{aligned}$$

where k is a constant.

$$V - Iz = -E_T$$

$$\frac{E_T + E_S}{z_a} = I_a$$

$$E_S = k' \varphi_S n$$

where n is the speed of the motor. Therefore,

$$\frac{-V + Iz + k' \varphi_S n}{z_a} = I_a$$

$$n = \frac{V - Iz + I_a z_a}{k' \varphi_S}$$

The current I_a is nearly in time phase opposition to the stator current. If the sign of I_a is reversed in order to refer the armature impedance drop to the stator, the equation for the speed of the repulsion motor becomes

$$n = \frac{V - Iz - I_a z_a}{k' \varphi_S} \quad (236)$$

This is also the equation for the speed of a series motor.

For any fixed current, an increase in the displacement of the brushes from the axis of the stator field increases φ_s , thus decreasing the speed as well as the power factor. The effect is much the same as adding turns to the main field winding of a series motor.

Commutation.—In better commutation, the repulsion motor has an important advantage over the simple series motor. Both types of motor have a transformer voltage induced in the short-circuited armature coils. This voltage is due to the main field in the series motor and to the component SS of the stator field in the repulsion motor. At starting there is no voltage to oppose this in either type of motor, and no choice, therefore, between the two types so far as commutation is concerned at starting. As the repulsion motor speeds up, however, a second voltage is induced in its short-circuited armature coils by the rotation of the armature in the component field TT . This speed voltage is nearly in time phase opposition to the transformer voltage and equal to it at synchronous speed. At synchronous speed, therefore, the commutation of the repulsion motor is perfect so far as the transformer action in the short-circuited armature coils is concerned. Between standstill and about 1.4 synchronous speed the conditions for commutation are better in the repulsion than in the series motor.

The vector sum of the two voltages E_T and E_S induced in the armature of the repulsion motor is equal to the impedance drop in the armature, equation (235), page 574. This impedance drop is caused by the armature effective resistance and the leakage reactance and except at low speeds should be small compared with either E_T or E_S . Therefore, except at low speeds, E_T and E_S are approximately equal.

$$E_S = k\varphi_S n \quad (237)$$

$$E_T = k\varphi_T f \quad (238)$$

where k , n and f are, respectively, a constant, the speed multiplied by the number of pairs of poles, and the frequency,

$$k\varphi_S n = k\varphi_T f \text{ approximately,}$$

and

$$\frac{\varphi_S}{\varphi_T} = \frac{f}{n} \text{ approximately} \quad (239)$$

At synchronous speed n and f are equal and the two fields are, therefore, approximately equal at this speed. This relation is independent of the position of the brushes with respect to the single distributed stator winding. Changing the position of the brushes alters the relative number of ampere-turns of the component fields SS and TT , but the ampere-turns of the field TT are not all magnetizing ampere-turns. The relation between the total and the magnetizing ampere-turns on the poles TT depends on the speed of the motor.¹

Let e_s and e_t be, respectively, the speed and transformer voltages induced in the short-circuited armature coils. The voltage e_t is induced by the flux φ_S and lags 90 degrees behind that flux and, therefore, 90 degrees behind the current I . The voltage e_s is induced by the flux φ_T and is in time opposition to that flux.

In order to determine whether e_s is in time phase with or in time opposition to the flux φ_T , use the convention given under the single-phase induction motor on page 527. According to this convention, a speed voltage is positive when it causes a current which produces a positive flux.

Refer to the small figure in the corner of Fig. 266. Assume left to right as the positive direction for φ_S . In the actual motor the effect of the poles TT and SS is secured by displacing the brushes from the axis of the stator field. Let the dot-and-dash line represent the axis of the actual stator winding. Poles 1 and 2 form one of the actual poles and 3 and 4 the other. If the positive direction of the flux φ_S is assumed from left to right, the positive direction of the flux φ_T must then be downward for the assumed direction of the stator axis. The direction of rotation must be clockwise. This can be seen as follows. Consider the instant when the current flow in SS is right-handed as seen from the left. The flux φ_S is then positive. Since T_2 and S_1 form one pole, the current in the winding on the poles TT is right-handed when seen from above. Therefore, the armature current, which is in opposition to the current in the winding on TT , must flow out on the left-hand side of the armature and in on the right-hand

¹ In a transformer the flux does not depend on the primary current alone but upon the vector sum of the primary and secondary currents. In the repulsion motor the armature current corresponds to the secondary current of the transformer and depends on the speed of the motor.

side. This armature current in conjunction with the field SS will cause clockwise rotation.

Consider the instant when the flux φ_T is positive, *i.e.*, downward, Fig. 267. This flux is produced by the magnetizing component of the current I and will be nearly 90 degrees behind I (see vector diagram, Fig. 266).

The flux φ_S is nearly in time phase with the current and approximately 90 degrees ahead of φ_T . The transformer voltage e_t , produced in the short-circuited armature coils, will be 90 degrees behind φ_S . According to the convention, the voltage e_s induced by rotation in the short-circuited armature coils is negative, that is, opposite in phase to the flux φ_T causing it and is, therefore, drawn upward on Fig. 267. The two voltages induced in the armature coils undergoing commutation are, therefore, opposite.

$$e_s = k''\varphi_T n$$

$$e_t = k''\varphi_S f$$

where k'' is a constant. n and f have the same significance as before.

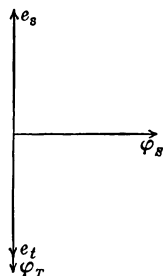

FIG. 267.

$$\frac{e_t}{e_s} = \frac{\varphi_S f}{\varphi_T n} \tag{240}$$

From equation (239), page 577,

$$\frac{\varphi_S}{\varphi_T} = \frac{f}{n}$$

Therefore,

$$\frac{e_t}{e_s} = \left(\frac{f}{n}\right)^2$$

For perfect neutralization of the transformer voltage e_t in the armature coils undergoing commutation

$$\frac{e_t}{e_s} = \left(\frac{f}{n}\right)^2 = 1$$

This condition can be fulfilled only at synchronous speed, where $f = n$. Above synchronous speed $\frac{e_t}{e_s}$ decreases rapidly and at $\sqrt{2} = 1.4$ synchronous speed the difference between e_s and e_t

is as great as at starting. Above 1.4 synchronous speed, the inherent conditions for commutation are worse than in the series motor. So far as commutation is concerned, the repulsion motor obviously operates best at synchronous speed.

The commutation of the repulsion motor, while being brought up to speed, may be improved by inserting a non-inductive resistance in the armature circuit. This resistance should be cut out and the armature brushes short-circuited as soon as the motor has reached operating speeds. As the conditions for commutation of a repulsion motor are inherently good in the neighborhood of synchronous speed, the resistance should be cut out before synchronous speed is reached. Inserting resistance while starting will also improve the power factor, but the higher power factor and the better commutation are obtained at a loss in efficiency. The loss due to the decrease in efficiency is not serious provided the resistance is used only for starting purposes. This method of starting may be used to advantage with doubly fed series or doubly fed repulsion motors. Such motors are usually started as simple repulsion motors. They are designed to have relatively low synchronous speed and to reach that speed quickly when starting. Under ordinary load conditions they operate above synchronism with no resistance in the armature circuit. The loss in the starting resistance should be no greater than for any direct-current series motor. The effect of short-circuiting the armature through resistance while starting may be shown as follows: From equation (240), page 579, the ratio of the two voltages induced in the short-circuited armature coils is

$$\frac{e_i}{e_s} = \frac{\varphi_S f}{\varphi_T n}$$

For good commutation these two voltages should neutralize and

$$\frac{\varphi_T n}{\varphi_S f} = 1 \quad (241)$$

The fluxes φ_T and φ_S must also be in both space and time quadrature. These conditions are exactly fulfilled only at synchronous speed. At the instant of starting n is zero, and φ_T is very nearly zero.

The repulsion motor will always speed up until equation (235), page 574, is fulfilled. According to equation (235)

$$E_S + E_T = I_a z_a \quad (242)$$

E_S is in time phase with φ_S and, therefore, nearly in time phase with I_a .

If resistance is inserted in the armature circuit, $I_a z_a$ will be increased for a given current and may be brought approximately in time phase opposition with E_S . Under this condition E_T will be approximately in phase with I_a . Since E_T is a transformer voltage, the flux φ_T producing it will be nearly in time quadrature with I_a and, therefore, with φ_S . This is the approximate phase relation existing between φ_S and φ_T at synchronous speed, with no resistance in the armature circuit. It is one of the two conditions which must be fulfilled for good commutation.

At a given speed and current, increasing the resistance in the armature circuit increases E_T and, therefore, φ_T and also tends to keep φ_T and φ_S in time quadrature.

Except for limits of saturation, equation (241) for good commutation may be satisfied by putting resistance in the armature circuit, provided n is not zero. Although the limits of saturation prevent equation (241) being satisfied when n is low, commutation during starting may be improved by inserting a moderate amount of resistance in the armature circuit. There should be no difficulty in making φ_T equal to φ_S . With no resistance in the armature circuit, the two fluxes are equal at synchronous speed, equation (239), page 577.

Comparison of the Series and Repulsion Motors.—There is little difference between the speed, torque, efficiency and current curves of simple series and simple repulsion motors, but the commutation of the repulsion motor is inherently the better between zero and 1.4 synchronous speed. This is about the only factor in favor of motors of the simple repulsion type. This superiority in commutation is most marked near synchronous speed and for this reason repulsion motors are designed so that their normal running speed is near synchronism. Above about 1.4 synchronous speed the commutation of the repulsion motor is inherently worse than that of the series motor. The repulsion motor has a distributed field winding without salient poles and for this reason

it requires a greater number of ampere-turns on its field for the same field strength than the series motor. Moreover, the armature current is derived from transformer action. This necessitates a good magnetic circuit along the axis of the armature brushes as well as along the axis of the component field SS . For this reason the repulsion motor must be somewhat heavier than a series motor of the same speed and output. The power factor of the simple repulsion motor is inherently less than the power factor of the series motor, since in addition to the reactive drop in the component field winding SS , Fig. 265, page 573, corresponding to the reactive drop in the main field winding of the series motor, the component field winding TT , in the repulsion motor carries a quadrature current which produces the flux φ_T . There is no corresponding component in the series motor. One minor advantage of the repulsion motor is that there is no electrical connection between its armature and field windings. For this reason, the field may be wound to receive power directly from high-voltage mains, without the use of a transformer. This is of little practical advantage, since motors of the repulsion and series types are almost always used under conditions requiring variable speed. Except with very small motors, economy dictates the use of a transformer for obtaining the variable voltage necessary for speed control. If a transformer be required, there is no especial advantage in being able to wind the stator for high voltage.

At operating speeds, the fields φ_T and φ_S are in space quadrature and very nearly in time quadrature. At synchronous speed they have been shown to be equal. Therefore, at synchronous speed the repulsion motor has a uniformly rotating field of constant strength. At speeds other than synchronism, the repulsion motor has an elliptical revolving field. Due to this rotating field, the rotor core loss at synchronous speed is small.

CHAPTER LXI

COMPENSATED REPULSION MOTOR; DIAGRAM OF CONNECTIONS; PHASE RELATIONS BETWEEN FLUXES, CURRENTS AND VOLTAGES; POWER-FACTOR COMPENSATION; COMMUTATION; VECTOR DIAGRAM; SPEED CONTROL AND DIRECTION OF ROTATION; ADVANTAGES AND DISADVANTAGES OF THE COMPENSATED MOTOR

Compensated Repulsion Motor.—The compensated repulsion motor differs from the uncompensated motor by having the reactance of its speed or torque field compensated. Therefore, its power factor is high. Compensation is obtained by making the armature winding produce the torque field and then neutralizing the reactance voltage produced in the armature winding by this torque field by means of a speed voltage induced in the armature by the transformer field.

The simple repulsion motor has a single field winding with the brushes displaced from the axis of this winding. Two windings with their axes at right angles might be used in place of the single winding. The fields produced by these windings would correspond to the component fields T and S , Figs. 264 and 265, pages 571 and 573. The brush axis would lie along the axis of the winding producing the transformer field T .

Two windings are unnecessary. The flux which would be produced by field winding S may be obtained from the armature winding by adding a second set of brushes placed with their axis at right angles to the axis of the transformer field winding T and to the axis of the other brushes as well. The first or original set of brushes will be called the power brushes since they carry the component of the armature current producing motor power. The axis of these brushes coincides with the axis of the transformer field T . The second set of brushes will be called the excitation brushes since they carry the current which produces the torque or speed field. If the excitation brushes are connected

to the secondary of an auto-transformer placed in series with the stator winding, a current will flow through the armature between these brushes, which will be nearly in time phase opposition to the stator current. This current will produce a field in space quadrature with the axis of the power brushes and nearly in time phase opposition to the current in the stator. This is the arrangement of the Winter-Eichberg compensated repulsion motor. Whether the speed or torque field is positive or negative, when the transformer field is positive, depends on the way the excitation brushes are connected to the series transformer. Reversing the connections of these brushes with the series transformer reverses the phase of the speed or excitation field with

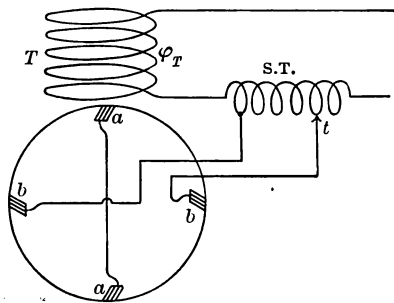

FIG. 268.

respect to the armature current and hence reverses the direction of rotation of the motor.

Diagram of Connections.—The diagram of connections of the compensated Winter-Eichberg motor is shown in Fig. 268.

T is the stator winding and corresponds to the winding of the component field T of the simple repulsion motor. It forms a transformer with the armature as considered with respect to the brushes aa . The armature considered with respect to the brushes bb corresponds to the component field S of the simple repulsion motor and produces the speed or torque field. The compensated repulsion motor, like the single-phase commutator-type induction motor, has its torque field produced by a component of its armature current. The difference in the characteristics of the two motors is due to the difference in the way the current for the torque field is produced. The single-phase commutator-type induction motor has the brushes bb short-circuited and has what is equivalent to shunt excitation. The compensated repulsion motor has the brushes bb connected to the terminals of a transformer, $S.T.$, in series with the motor and has series excitation,

therefore. Either of the two types may easily be converted into the other, so far as excitation is concerned.

The relative number of ampere-turns on the two component fields of the simple repulsion motor depends upon the position of the brushes. The ampere-turns of neither component can be changed without changing the ampere-turns of the other. For a given stator current and speed, the ampere-turns of the component fields of the compensated repulsion motor depend on the position of the tap t on the series transformer. The excitation of the motor, therefore, may be varied independently of the field T and of the current in the armature. By varying the excitation, the ratio of the fluxes φ_T and φ_S of the motor may be varied to meet the condition for good commutation at the brushes aa over a wide range of speed. The condition which gives good commutation is the same as that required for compensation of the reactance of the torque field and results in high power factor.

Phase Relations between Fluxes, Currents and Voltages.—

The current in the armature between the brushes bb is nearly in time phase opposition to the stator current. It would be exactly in opposition were it not for the exciting current of the series transformer. Hence, the currents in the two component fields SS and TT of the compensated motor are nearly in time phase opposition. In the simple repulsion motor the current is the same in both component fields which are produced by displacing the brush axis from the axis of the single stator winding. The two motors differ only in the way the torque field is produced. If the component fluxes φ_T and φ_S of the simple repulsion motor are in time quadrature, the corresponding fluxes of the compensated repulsion motor must also be in time quadrature. The relative magnitudes of the fluxes φ_T and φ_S of the simple motor are fixed by the speed, equation (239), page 577. Their relative magnitudes in the compensated repulsion motor are determined by the speed and by the position of the tap t on the auto-transformer. At any speed, the relative magnitudes of the two component fluxes may be changed by changing the position of the tap t .

In the armature of the simple repulsion motor, there are two voltages to be considered: a speed voltage, E_S , due to the flux φ_S , and a transformer voltage, E_T , due to the field φ_T , Fig. 265, page 573. These two voltages also exist between the brushes aa of

the compensated repulsion motor, in which there are in addition two similar voltages between the brushes bb , a speed voltage due to φ_T , and a transformer voltage due to φ_S . Since φ_T and φ_S are both in space quadrature and also nearly in time quadrature, the two voltages they produce in any given circuit on the armature must be nearly in time phase opposition.

The letter E will be used with three subscripts to indicate a voltage induced in the armature between either set of brushes. A letter, a or b , will indicate which set of brushes is considered, S or T , will indicate the field which is producing voltage and s or t will indicate whether the voltage is a speed or a transformer voltage.

Power-factor Compensation.—The power factor of the repulsion motor is determined largely by the reactance of its torque field. If this can be compensated for, the power factor of the motor will be high. It will not be unity even in this case on account of the magnetizing current required for its transformer field. By over-compensating, it may be made unity, however. In the circuit formed by the series transformer $S.T.$ and the armature between the excitation brushes bb , there are three voltages, namely: the voltage E_{bT_s} produced by the rotation of the armature in the field φ_T , the voltage E_{bSt} produced by the transformer action of the field φ_S and the voltage impressed across the brushes bb by the series transformer $S.T.$ The voltage across the brushes bb and also that across the secondary of the series transformer are each equal to

$$E_{bSt} + E_{bT_s} - I_b z_b$$

where $I_b z_b$ is the impedance drop in the armature between the brushes bb due to the armature resistance and leakage reactance. The voltages E_{bSt} and E_{bT_s} are nearly in time phase opposition and are nearly in quadrature with the current I taken by the motor.

If $E_{bSt} = -E_{bT_s}$, the potential across the primary of the series transformer $S.T.$, Fig. 268, is equal to the equivalent impedance drop of the transformer plus a voltage equal to the impedance drop $I_b z_b$ in the armature. The armature impedance drop must, of course, be multiplied by the ratio of transformation of the transformer $S.T.$ Since $I_b z_b$ and the equivalent drop in the

transformer are both small, the power factor of the motor will be determined principally by the magnetizing current for the stator field φ_T .

Neglecting the leakage-impedance drops in the armature between the brushes bb and in the transformer the two voltages E_{bSt} and E_{bTs} should be equal for perfect compensation of the exciting circuit of the motor. The exciting circuit includes the transformer $S.T.$ and the armature circuit between the brushes bb .

$$\begin{aligned} E_{bSt} &= k\varphi_S Nf \\ E_{bTs} &= k\varphi_T Nn \end{aligned}$$

where k , N , f and n are, respectively, a constant, the number of effective armature turns, the frequency and the speed in revolutions per second multiplied by the number of pairs of poles. E_{bSt} is the reactance voltage due to the speed or torque field S . For perfect compensation of the torque field, this voltage must be neutralized. For perfect compensation of the exciting circuit

$$E_{bSt} = - E_{bTs}$$

Therefore, for perfect compensation of the exciting circuit

$$\varphi_S f = \varphi_T n$$

or

$$\frac{n}{f} = \frac{\varphi_S}{\varphi_T}$$

For perfect compensation of the exciting circuit at synchronous speed, φ_S should be equal to φ_T . Under this condition the motor will operate at a power factor determined almost wholly by the magnetizing and load components of the current in the stator winding.

With φ_S and φ_T equal, there would be perfect compensation at synchronous speed for the motor and for the series transformer were it not for the stator magnetizing current. At speeds other than those near synchronous speed, the compensation will be defective when φ_S and φ_T are equal. It may be made quite good at starting and at speeds above synchronism by adjusting the

excitation φ_S as the motor speeds up, in such a way that the relation

$$\frac{n}{f} = \frac{\varphi_S}{\varphi_T} \quad (243)$$

is approximately fulfilled. This is accomplished by changing the position of the tap t on the transformer $S.T.$, Fig. 268. The flux φ_S is fixed by the current taken by the motor. Neglecting the drops in the stator, φ_T is fixed by the voltage impressed across the stator. Since the voltage drop across the series transformer is small, φ_T is very nearly fixed by the voltage impressed on the motor and its series transformer considered as a unit. For any given impressed voltage, φ_T will be approximately fixed while φ_S will change with the load, increasing as the speed n decreases.

For any fixed impressed voltage and position of the tap t , the degree of compensation and, hence, the power factor will vary with the load. By making the adjustment for compensation at the average running load, the impressed voltage being fixed, the power factor may be maintained high over the range of load ordinarily used without changing the impressed voltage. When the impressed voltage is changed, the position of the tap t on the series transformer must be changed to produce compensation for the new condition.

Commutation.—The conditions which give perfect compensation for the exciting circuit, also produce perfect commutation at the power brushes aa in so far as the commutation at these brushes is influenced by the transformer action in the short-circuited coils. The other commutation difficulties are those found in any direct-current motor or generator and may be dealt with in the same manner as in these machines.

Consider the armature coils short-circuited by the power brushes aa . The excitation flux φ_S produces a transformer voltage in these coils in time quadrature with that flux. A voltage will also be induced in these coils by their rotation in the field φ_T . These two voltages will be in time phase opposition as in the simple repulsion motor. Call them e_t and e_s respectively. Then

$$\begin{aligned} e_t &= k'N'\varphi_S f \\ e_s &= k'N'\varphi_T n \end{aligned}$$

where N' is the number of turns between commutator bars in an armature coil. For complete neutralization of the two voltages e_t and e_s

$$\begin{aligned} \varphi_S f &= \varphi_T n \\ \frac{n}{f} &= \frac{\varphi_S}{\varphi_T} \end{aligned} \tag{244}$$

This is also the condition for perfect compensation of the speed field.

Let e'_t and e'_s be the two voltages induced in the armature coils short-circuited by the exciting brushes bb . Then

$$\begin{aligned} e'_t &= k' N' \varphi_T f \\ e'_s &= k' N' \varphi_S n \end{aligned}$$

For neutralization of these voltages e'_t must equal e'_s and

$$\begin{aligned} \varphi_T f &= \varphi_S n \\ \frac{n}{f} &= \frac{\varphi_T}{\varphi_S} \end{aligned}$$

This is not the condition for perfect compensation of the excitation circuit or for perfect commutation at the power brushes aa . Complete compensation and perfect commutation at both sets of brushes can simultaneously be obtained only at synchronous speed, and then only if φ_T equals φ_S .

To maintain good commutation at the power brushes and perfect compensation for the exciting circuit, it is necessary to vary φ_S with the speed in such a way that the relation $\frac{n}{f} = \frac{\varphi_S}{\varphi_T}$ is approximately satisfied. This is accomplished by changing the position of the tap t on the series transformer as the voltage across the whole motor is changed in order to vary its speed. The voltage impressed on the motor is usually changed by means of a compensator with a number of taps on its secondary. For low speeds as at starting φ_S should be small. It should be large for high speeds. By varying φ_S , as the voltage across the motor is changed, permissible power factors and satisfactory commutation at the power brushes may be obtained not only at synchronous speed, but at starting and at speeds somewhat above synchronism as well.

The lack of fulfilment of the conditions for complete neutralization of the transformer and rotation voltages in the armature coils short-circuited by the excitation brushes bb is not serious. By the use of narrow brushes of comparatively high resistance the commutation may be made satisfactory. The current carried by the brushes bb will be smaller than the current carried by the brushes aa in approximately the ratio of the stator magnetizing current to the total stator current.

The possibility of compensation by the series transformer is limited by the saturation in the magnetic circuit for the flux φ_s . For this reason, commutation becomes defective at speeds much in excess of synchronism unless the motor is made unduly heavy. This difficulty may be met by the use of auxiliary commutating coils placed on the stator over the armature coils short-circuited by the power brushes aa . These commutating coils are not distributed. Each spans only the zone occupied by the short-circuited armature coils, and its effect is limited to that zone. The commutating coils are either short-circuited or connected in series with the stator winding in such a way as to oppose the flux φ_T at the points at which the coils are placed. The effect of these coils is to reduce the flux due to the field T within the commutating zones. This reduces the speed voltage in the armature coils short-circuited by the brushes aa . In this way good commutation may be maintained above synchronous speed. While starting, as well as while the motor speed is below synchronism, the commutating coils are cut out. When the speed of the motor exceeds synchronism, they are automatically inserted.

Vector Diagram.—The operation of the compensated repulsion motor may be made clearer by a vector diagram. The current producing the speed field will be assumed to be in phase with the flux φ_s which it produces. This assumption was made in the simple repulsion motor and also in the series motor. For perfect compensation the drop in potential across the series transformer is small. It is merely that due to the equivalent impedance drop in the transformer and the leakage-impedance drop in the motor armature between the brushes bb . The exciting current of the series transformer for this small voltage drop may be neglected and will be neglected in the vector diagram. All currents and voltages are referred to the stator of the motor.

The vector diagram is shown in Fig. 269. The part which applies to the stator and armature considered with respect to the brushes aa is the same as the part of the diagram of the uncompensated repulsion motor which applies to its armature and transformer field.

Referring to Fig. 269, let I be the stator current. This is also the current taken by the motor. The current I is divided into

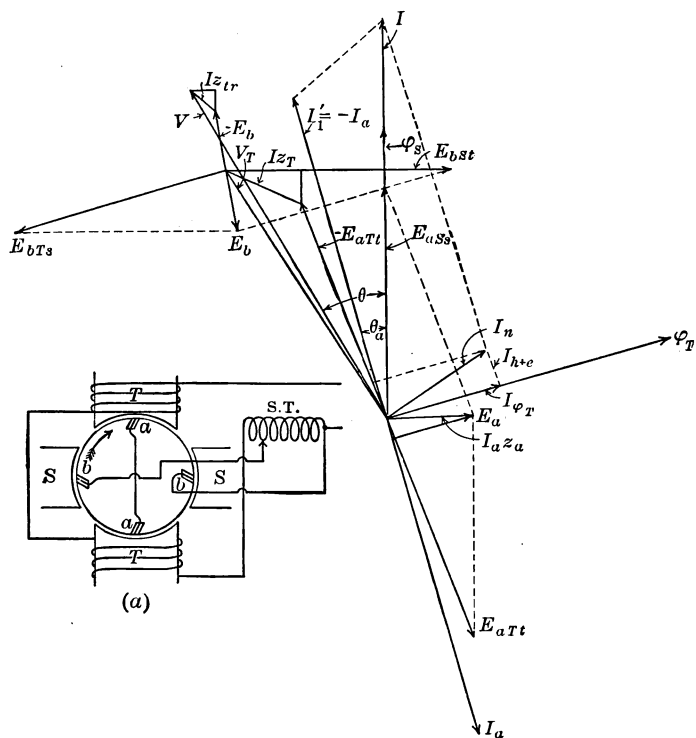

FIG. 269.

the three components I'_1 , $I_{\phi T}$ and I_{h+e} as it was for the uncompensated motor. I_a is the armature current between the brushes aa . It is equal and opposite to I'_1 . The flux ϕ_T , in phase with $I_{\phi T}$, is produced by the stator. Since the exciting current for the series transformer is neglected, the current I_b in the armature between the brushes bb is equal to the stator current I .

Its phase with respect to the stator current is determined by the way the brushes bb are connected to the series transformer $S.T.$ Reversing the connections of the brushes reverses the phase of the armature current between these brushes with respect to the stator current. If the current between bb flows in such a direction as to produce positive flux, it will be positive current, page 528. The connections will be assumed so as to make I_b positive. The field φ_S will then be positive as shown. The direction of the field φ_S and the armature current I_a between the brushes aa fixes the direction of rotation, which will be clockwise.

The two fluxes φ_T and φ_S are shown equal. This corresponds to the condition of perfect compensation at synchronous speed, which condition is assumed. The two voltages in the armature between the brushes aa are E_{aTt} and E_{aSs} and their resultant is E_a . E_{aTt} is 90 degrees behind φ_T . According to the convention for determining the direction of a speed voltage, E_{aSs} is in time phase with φ_S and with I . The component current I_a in the armature lags behind E_a , the resultant of E_{aTt} and E_{aSs} , by an angle which is determined by the resistance and leakage reactance of the armature between the brushes aa .

A voltage $-E_{aTt}$, equal and opposite to E_{aTt} , must be impressed on the stator to balance the voltage induced by φ_T . Adding the stator leakage-impedance drop Iz_T , of the stator, to this voltage gives the voltage drop V_T across the stator. Thus far the diagram is exactly like that for the uncompensated motor.

There are two voltages in the armature between the brushes bb which must now be considered. These are the transformer voltage E_{bSt} and the speed voltage E_{bTs} . As perfect compensation is assumed, these voltages are equal. E_{bSt} is 90 degrees behind φ_S , and according to the convention E_{bTs} is opposite in time phase to φ_T . The resultant E_b of these two voltages is equal to the resistance and leakage-reactance drops through the armature between the brushes bb and is equal to the voltage which must be impressed across the brushes bb by the series transformer. The voltage drop across the primary of the series transformer is equal to $-E_b$ plus the equivalent leakage-impedance drop Iz_{tr} in the transformer. Adding $-E_b$ and this equivalent impedance drop to V_T gives the voltage V , which must

be impressed across the whole motor, including the series transformer.

Comparing Figs. 266 and 269, pages 575 and 591 respectively, it will be seen that the power factor of the compensated motor is much higher than the power factor of the uncompensated motor.

On Fig. 266, the reactance part of the impedance drop Iz_S corresponds nearly to the voltage $-E_{bSt}$ on Fig. 269, and is 90 degrees ahead of the current. E_{bSt} , Fig. 269, is the real reactance voltage rise due to the speed field flux and is 90 degrees behind the flux. It is the neutralization of this voltage by the speed voltage which improves the power factor. Compensation by this method brings the impressed voltage into phase with the stator current by neutralizing a reactive drop. The power factor of the transformer formed by the stator and the armature considered with respect to the brushes aa is not changed. When compensation is effected by adding voltage to the armature between the brushes bb , as was done in the single-phase commutator-type induction motor, the power factor is corrected by bringing the stator current into phase with the stator impressed voltage by neutralizing the magnetizing component of the stator current (see Figs. 238 and 239, pages 536 and 537, under "Single-phase Induction Motors"). The same method of power-factor adjustment could be applied to the series motor but it would require the use of an additional transformer. In the series motor the effect of the magnetizing current in the stator on power factor may be compensated by properly adjusting the two fields φ_S and φ_T , but in so doing the conditions for best commutation will be sacrificed.

Speed Control and Direction of Rotation.—The speed of the compensated repulsion motor, like the speed of any series or repulsion motor, is varied by varying the voltage impressed across its terminals. The variation in voltage necessary for speed control may be obtained from a transformer or compensator with a number of secondary taps which are connected to the motor in succession by some type of drum controller.

If the voltage is increased, the motor will speed up and develop more power. As the motor is speeded up by increasing the voltage impressed, the voltage at the secondary of the series exciting transformer must be increased in proportion to the increase in

speed, to maintain good commutation and power-factor compensation. This may be done by the controller which varies the speed. Above synchronous speed the auxiliary commutating coils mentioned on page 590 are inserted.

The direction of rotation is reversed by reversing the secondary connections of the series transformer, thus reversing the excitation and the speed of the motor.

Advantages and Disadvantages of the Compensated Motor.—The chief advantages of the compensated repulsion motor are high power factor and good commutation at the brushes which carry the armature power current. Both high power factor and good commutation may be maintained over a considerable range of speed. The upper limit of speed at which good operating characteristics can be maintained is fixed by the saturation of the magnetic circuit for the speed field. The chief objection to the compensated motor is the necessity for using brushes for which the inherent conditions of commutation are poor except at synchronous speed. Twice as many brushes are required as for an uncompensated motor and it is often difficult to find room for these without increasing the overall dimensions of the motor. The presence of the extra brushes increases the friction losses and also the commutation losses.

CHAPTER LXII

DOUBLY FED SERIES AND REPULSION MOTORS; DOUBLY FED SERIES MOTOR; APPROXIMATE VECTOR DIAGRAM OF THE DOUBLY FED SERIES MOTOR; COMMUTATION OF THE DOUBLY FED SERIES MOTOR; STARTING AND OPERATING THE DOUBLY FED SERIES MOTOR; DOUBLY FED REPULSION MOTOR; DOUBLY FED COMPENSATED REPULSION MOTOR; REGENERATION BY THE DOUBLY FED COMPENSATED REPULSION MOTOR; ADVANTAGES AND DISADVANTAGES OF THE TWO TYPES OF DOUBLY FED MOTORS; COMPENSATION AND COMMUTATION OF THE DOUBLY FED COMPENSATED REPULSION MOTOR; STARTING AND SPEED CONTROL OF THE DOUBLY FED COMPENSATED REPULSION MOTOR

Doubly Fed Series and Repulsion Motors.—Doubly fed series and repulsion motors differ from singly fed motors of the same types in having their armatures receive power in two ways: namely, by conduction usually from a transformer across the line, and by induction from a portion of the stator winding. This part of the stator winding receives power from a portion of the transformer which feeds the armature. The chief advantage of doubly fed motors over motors of the singly fed types is better commutation over a greater operating range of speed.

The diagrams of connections for doubly fed series motors and doubly fed repulsion motors are shown in Figs. 252 and 253, page 557 and also in Figs. 270 and 272, pages 596 and 600, respectively.

The simple or singly fed series motor has inherently bad commutating characteristics on account of the transformer voltage induced by the main field in the armature coils undergoing commutation. As there is nothing to oppose this voltage, resistance leads must be used between the commutator bars and the armature winding to make satisfactory commutation possible. In the doubly fed series motor, the armature and compensating field

form a transformer. The flux produced by this transformer is 90 degrees in space phase, and nearly 90 degrees in time phase from the flux of the main series field. It induces a speed voltage in the armature coils undergoing commutation which tends to neutralize the transformer voltage in these coils and to improve commutation. These two voltages may be made to neutralize sufficiently to make the use of commutating resistance leads between the armature winding and the commutator bars unnecessary.

The simple or singly fed repulsion motor inherently has good commutating characteristics in the neighborhood of synchronous speed. By doubly feeding the repulsion motor and at the same time arranging the series field so that its strength may be varied

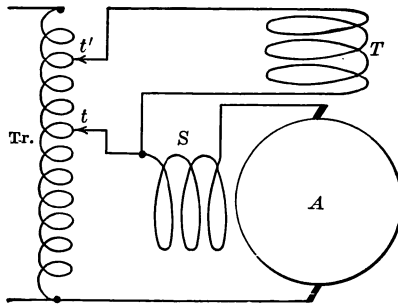

FIG. 270.

with the speed, the conditions which produce good commutation may be maintained at speeds considerably in excess of synchronous speed.

Doubly Fed Series Motor.—The diagram of connections of a doubly fed series motor is given by Fig. 270.

This figure is like Fig. 252, page 557, except that the compensating field is lettered *T* to correspond to the lettering used for the simple and compensated repulsion motors. The transformer which supplies the motor is marked *Tr.*

Assuming a ratio of transformation of unity between the armature and the compensating winding *T*, and neglecting the exciting ampere-turns for the transformer formed by *T* and the armature *A*, the currents in all parts of the motor are equal and either in time phase or in time phase opposition. The exciting ampere-turns

for this transformer are equal to the vector sum of the armature ampere-turns and the ampere-turns in the field winding T . They cannot be considered to be confined to either the armature or to the compensating winding alone, as both receive power.

Changing the relative position of the taps t and t' changes the voltage impressed across the transformer formed by the winding T and the armature A and alters the flux along the line of the brush axis. The presence of this flux does not increase the reactance drop through the motor, since the armature and the winding T form a static transformer. The only voltage drops in the transformer thus formed are the leakage-reactance and the resistance drops in these windings. These reactance and resistance drops also exist in the armature and in the compensating field of the singly fed series motor.

Bringing the taps t and t' together changes the motor to a simple inductively compensated series motor. Disconnecting the motor from the transformer at t changes it to a simple conductively compensated series motor. Doubly feeding the motor by moving the taps t and t' apart produces a commutating flux at the brushes and changes the speed. Moving t' upward from t (Fig. 270) causes a voltage, E_t , to be induced in the armature which is very nearly in time phase with the voltage V_a impressed on the armature and speed field by the main transformer Tr . The motor must speed up until its back electromotive force is equal to the total voltage $V_a + E_t$ acting in the armature circuit less the total impedance drop in the armature and in the speed field S . Increasing the total voltage in the armature circuit by adding the voltage E_t , induced by the stator winding T , increases the speed, therefore.

Approximate Vector Diagram of the Doubly Fed Series Motor.

—For equilibrium of speed

$$E_{S_s} = V_a + E_t - I_z$$

where E_{S_s} is the back electromotive force of the motor. This is the speed voltage produced in the armature between the brushes aa by the field S . I_z is the total impedance drop in the armature and speed field. Assuming a ratio of transformation of unity between the armature and the field winding T and neglecting the resistance and leakage-reactance drops in the winding T , the

voltage E_t is opposite in time phase and equal in magnitude to the voltage V_t impressed on the stator winding T by the transformer Tr . The motor must, therefore, speed up until the back electromotive force E_{S_s} is equal to $V_a \pm V_t$ less the series-field and armature impedance drops. The sign before V_t is determined by the way the winding T is connected to the transformer Tr . In practice it is always connected to make E_t and V_a in phase. The approximate vector diagram of the doubly fed series motor is shown in Fig. 271.

Iz and E_{S_s} are voltage drops. V_a is the voltage drop across the armature and series field. $E_t = V_t$ is also a voltage drop.

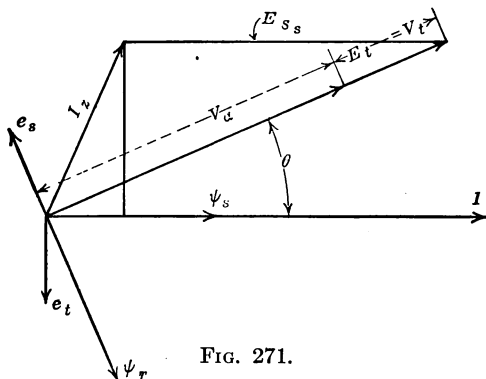

FIG. 271.

The flux φ_T producing the voltage E_t is 90 degrees behind of that voltage. For any given current, I , the relative magnitudes of φ_s and φ_T are fixed by the voltage V_t and therefore by the positions of the taps t and t' on the transformer Tr .

Commutation of the Doubly Fed Series Motor.—The flux φ_T induces a speed voltage, e_s , in the armature coils undergoing commutation. This voltage is in time phase opposition with the flux φ_T . The flux φ_s also induces a voltage in these coils, but this is a transformer voltage and is in time quadrature with and lagging the flux. These two voltages would be in time phase opposition were θ zero. In practice they may be made to neutralize sufficiently to make commutating leads unnecessary. For a given current, their relative magnitudes depend upon the speed and upon the relative positions of the taps t' and t . For any given current and given position of the taps, there will be a

speed at which the two voltages will be equal. They will be nearly enough equal for ordinary speed variations on each side of this speed to produce satisfactory commutation.

The speed of the doubly fed series motor is controlled by varying the voltages across both the armature and series field and also the voltage across the stator winding T in such a way as to maintain approximately the conditions for good commutation.

For perfect commutation

$$e_i = e_s$$

$$k'N'\varphi_S f = k'N'\varphi_T n$$

where k' , N' , f and n are respectively, a constant, the number of turns per armature coil, the frequency and the speed multiplied by the number of pairs of poles.

$$\frac{\varphi_S}{\varphi_T} = \frac{n}{f}$$

For any given current, φ_S is constant. Therefore, to produce good commutation at any fixed current, φ_T should vary inversely as n . That is, to maintain good commutation the voltage across the stator field T should be decreased as the speed of the motor is increased. The speed is increased by increasing the voltage impressed on the armature and the main field.

Starting and Operating the Doubly Fed Series Motor.—Doubly fed series motors are usually started and brought up to speed as singly fed repulsion motors. Above synchronous speed they operate as doubly fed series motors. For better commutation, resistance may be inserted in the armature during the period while coming up to synchronous speed as a repulsion motor, page 580.

Doubly Fed Repulsion Motor.—In order to gain anything by doubly feeding a repulsion motor, it is necessary to arrange the motor circuits in such a way that the strength of the series or speed field S , Fig. 253, page 557, may be varied as the speed of the motor is changed. This can be accomplished by using independent windings for the speed and the compensating or transformer fields, instead of the usual single distributed stator winding of the simple repulsion motor. The variable excitation may then be obtained by connecting the terminals of the speed field S to

the secondary terminals of a series transformer or compensator which is placed in series with the compensating field C , Fig. 253. The strength of the speed field may be varied independently of the current taken by the motor by using different secondary taps on this series transformer. The diagram of connections for a doubly fed repulsion motor with variable excitation is shown in Fig. 272, where T is the winding marked C in Fig. 253.

$S.T.$ is the series transformer or compensator to furnish the variable excitation for the speed field S . Tr is the transformer supplying the motor.

The doubly fed repulsion motor, Fig. 272, possesses no particular advantages over the doubly fed series motor and has the

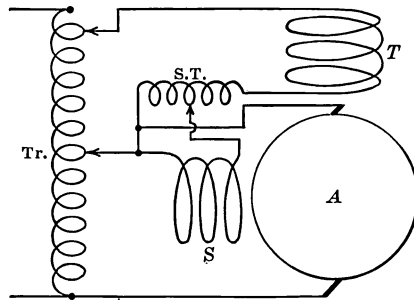

FIG. 272.

distinct disadvantage of requiring a series transformer or compensator for exciting its speed field.

Doubly Fed Compensated Repulsion Motor.—The Winter-Eichberg type of compensated repulsion motor, if doubly fed, possesses two distinct advantages over the doubly fed series motor for railway service, namely, the power to regenerate and power-factor compensation. By a slight modification of its connections, it may be changed into a doubly fed single-phase induction motor and as such may be made to regenerate and return electric power to the line over a wide range of speed.

The diagram of connections for the doubly fed compensated repulsion motor is shown in Fig. 273.

It is possible to operate this motor at speeds as high as three times synchronous speed and still maintain approximately the

conditions for good commutation at the power brushes aa , and for compensation of the reactance of the speed field S .

The doubly fed compensated repulsion motor of the Winter-Eichberg type, Fig. 273, is usually designed with about three times as many poles as the simple repulsion motor and has, therefore, a relatively low synchronous speed. It is started as a simple singly fed repulsion motor, with the brushes aa short-circuited, and, as its synchronous speed is relatively low, it quickly reaches that speed under normal conditions of acceleration. Hence, as a simple repulsion motor, it quickly reaches its best operating speed. For higher speeds it is doubly fed.

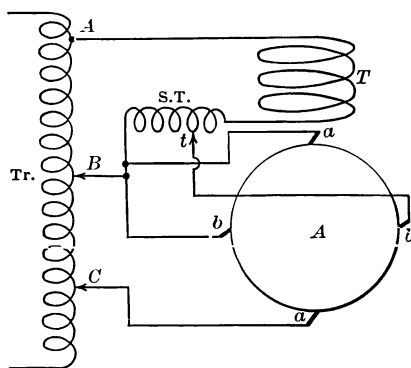

FIG. 273.

Regeneration by the Doubly Fed Compensated Repulsion Motor.—For regeneration the motor is changed to a doubly fed commutator-type induction motor by short-circuiting the brushes bb and the series transformer. Under this condition the motor is like the single-phase induction motor shown in Fig. 240, page 540. Its speed for regeneration will be either approximately synchronous speed or greater than synchronous speed, according as the voltage inserted in the armature between the power brushes aa is zero or greater than zero. To increase the speed at which regeneration takes place, the voltage added to the armature must be in phase with the voltage induced in the armature by the transformer field.

Advantages and Disadvantages of the Two Types of Doubly Fed Motors.—Aside from a somewhat higher power factor the

Winter-Eichberg doubly fed repulsion motor possesses no advantages over the doubly fed series motor for railway work, except when used on roads with heavy grades where regeneration of power is desirable. Both the advantages of higher power factor and of regeneration are obtained at a sacrifice of simplicity. The doubly fed series motor requires only one-half as many brushes for the same number of poles and as it would be wound for fewer poles than the doubly fed repulsion motor it will actually require less than half as many brushes as that motor. There is no question between the two motors so far as commutation at the brushes *aa* is concerned. Except in the neighborhood of synchronous speed, the commutation at the field brushes *bb* of the repulsion motor is inherently poor. As the current carried by those brushes is smaller than that carried by the power brushes, satisfactory commutation may be maintained at them by using proper brushes.

Compensation and Commutation of the Doubly Fed Compensated Repulsion Motor.—The condition for good commutation at the power brushes *aa* and for perfect compensation of the speed field is (equation (244), page 589)

$$\frac{n}{f} = \frac{\varphi_S}{\varphi_T}$$

Therefore, to maintain approximately this condition, the field φ_S must be increased when the speed of the motor is increased by increasing the voltage for double feeding. At a fixed current, φ_S is approximately constant. The frequency f is constant. Therefore, if the conditions for good commutation and compensation are to be fulfilled at each speed for normal current, the field φ_S must be changed in direct proportion to the speed. This can readily be accomplished by moving the connection t of the auto-transformer, Fig. 273, to the left as C is moved downward to increase the speed.

Starting and Speed Control of the Doubly Fed Compensated Repulsion Motor.—For starting, C and B , Fig. 273, are brought together and both are moved toward A to reduce the voltage across the transformer field T . The speed field is weakened by moving t on the series transformer to the right. As the motor speeds up B and C are moved downward, and at the same time t is

moved to the left. This is continued until synchronous speed at normal current is reached. For higher speeds B remains fixed and the motor is doubly fed by moving C downward. At the same time t is moved to the left to maintain approximately the conditions for good commutation and compensation. The different connections for starting and for changing the speed can easily be made by a drum type of controller operating suitable contactors.

For regeneration the series transformer $S.T.$ and the brushes bb are short-circuited. The speed at which regeneration takes place is determined by the position of C . If C is moved to B , regeneration will occur at a speed slightly in excess of synchronous speed. The difference between the actual speed and synchronous speed is the slip required to produce regeneration as an induction generator. Moving C downward increases the speed at which regeneration takes place.

INDEX

The eight sections into which the book is divided are indexed under the eight following headings: Synchronous Generators, pp. 605-607; Static Transformers, pp. 607-608; Synchronous Motors, pp. 608-609; Parallel Operation of Alternators, pp. 609-610; Synchronous Converters, p. 610; Polyphase Induction Motors, pp. 610-611; Single-phase Induction Motors, pp. 611-612; Series and Repulsion Motors, pp. 612-614. To facilitate the use of these section indices, a subject index is given. The page numbers in the subject index refer to the section indices.

SUBJECT INDEX

- Alternators**, *see* Generators.
Converters, Induction, *see* Single-phase Induction Motors, p. 611; Synchronous, p. 610.
Generators, Induction, *see* Polyphase Induction Motors, p. 611; Synchronous, pp. 605-607; Synchronous, Parallel Operation of, *see* Parallel Operation of Alternators, pp. 609-610.
Motors, Induction, Polyphase, pp. 610-611; Induction, Single-phase, pp. 611-612; Series and Repulsion, pp. 612-214; Synchronous, pp. 608-609.
Regulators, Induction, *see* Static Transformers, p. 607.
Transformer, Static, pp. 607-608.

SECTION INDICES

- SYNCHRONOUS GENERATORS**, pp. 1-150
- Air gap**, influence of, on regulation, 79, 83; effect of, on armature reaction, 79.
- Alternators**, types of, 1.
- American Institute**, method of determining regulation, 104, 105, 149; permissible temperatures for insulation, 18; method of determining efficiency, 132, 150.
- Armature**, *see* Cores, Insulation, Reactance, Resistance and Windings.
- Breadth factor**, 39; table of, 41.
- Blondel two-reaction method** of determining regulation, 106, 115.
- Calculation**, of regulation, efficiency, etc., 142.
- Characteristics**, open-circuit, 96; short-circuit, 96.
- Coils**, types of, 29.
- Cooling**, 15; radial, 16; circumferential, 17; axial, 17; filtering or washing air for, 17.
- Cores**, armature, 4; field, 9.
- Core losses**, 123; measurement of, 126, 128.
- Distribution of armature winding**, 29; effect of, 45.
- Efficiency**, 131, 150.
- Electromotive force**, induced, 20; calculation of, 21, 24; phase relation between e.m.f. and flux, 22; wave form of, 23; harmonics in, 42, 44, 45, 47.

SYNCHRONOUS GENERATORS

Field, types of, 9; insulation of, 14; flux, distribution of, 10, 54, 84.

Flux, 53; distribution of, 10, 54, 84; second harmonic in of, single-phase alternator, 59; leakage, 53; armature leakage, 56, 66, 75, 77, 80.

Frames, *see* Armature Cores, 4.

Frequency, 4.

Harmonics, 42; effect of pitch on, 44; effect of phase spread on, 45; in three-phase alternators, 47; due to slots, 50; third in electromotive force of single-phase alternators, 59; second in field flux of single-phase alternator, 59.

Heating tests, 136; zero power factor, 136; separate open-circuit and short-circuit, 137; Hobart and Punga, 138; Goldsmith, 139; Mordey, 140.

Inductor, 22, alternator, 3.

Insulation, armature, 12; field, 14; permissible temperatures for, 18.

Losses, 123; measurement of, 126, 127, 128.

Magnetomotive forces, 53.

Magnetomotive-force method, for determining regulation, 90, 93, 95, 98, 105, 106.

Open-circuit, characteristic, 96.

Phase, relation between e.m.f. and flux, 22; spread, 38; effect of phase spread on wave form, 45.

Pitch, pole, 37; coil, 37; factor, 43; effect of, on harmonics, 44.

Potier, method of determining regulation, 100; triangle, 148.

Rating, 51; single-phase rating, 83

Reactance, armature leakage, 52, 66, 80, 144; equivalent leakage, 77; methods of measuring armature leakage, 102, 118, 119, 148; synchronous, 91, 98, 104, 149.

SYNCHRONOUS GENERATORS

Reaction, armature, 53; with non-salient poles, 58; with salient poles, 64, 145; second harmonic in flux and third harmonic in e.m.f. due to, 59; factors which influence, 79; from Potier triangle, 102, 148; components of, in Blondel two-reaction method, 106.

Regulation, 52; conditions for best, 82; from vector diagram, 87; from synchronous-impedance method, 90, 91, 95, 98; magnetomotive-force method, 90, 93, 95, 99, 105, 106; Potier method, 100; American Institute method, 104, 105, 149; Blondel two-reaction method, 106.

Resistance of armature, effective 78, 82; determination of, with field removed, 121; from short-circuit test, 127.

Retardation method, of measuring losses, 128.

Short-circuit, characteristic, 96; core losses, 127; sustained current, 133; transient current, 133.

Slots, effect of shape of, on armature effective resistance, 68; effect of shape of, on leakage reactance, 80; effect of, on poleface losses, 124; effect of, on eddy-current losses in inductors, 124.

Stampings, armature core. 4; field core, 9.

Synchronous, reactance, 91, 98, 104, 149; impedance, 92; regulation by synchronous-impedance method, 90, 91, 98, 149.

Temperature, permissible for insulation, 18.

Types, of alternators, 1.

Vector diagram, general, 84; synchronous impedance, 91; magnetomotive force, 93; short-

SYNCHRONOUS GENERATORS

- circuit, 93, 94; Blondel two-reaction, 113.
- Wave form**, effect of pitch on, 44; effect of coil spread on, 45; effect of Y and Δ connection on, 47.
- Windings**, open and closed circuit, 27; bar and coil, 28; concentrated and distributed, 29; whole and half coiled, 30; spiral, lap and wave, 33; single and polyphase, 35; bracing of, 37; pitch of, 37; effect of pitch of, on wave form, 44; distribution, effect of, on wave form, 45.

STATIC TRANSFORMERS,

pp. 151-296

- Auto-transformer**, 231.
- Breathers**, 163.
- Calculation**, of regulation, losses, reactance, efficiency, etc., 288.
- Cases**, types of, 160.
- Coils**, types of, 155; insulation of, 155.
- Compensator**, *see* Auto-transformer.
- Connections**, Δ and Y, 252; testing for Δ and Y connections, 255; open Δ and V, 257; T, 259; Scott, 262; wave distortion by T, 263; three-to six-phase, 265; double Δ and double Y, 265; diametrical, 267; double T, 268; three-to twelve-phase, 269.
- Constant-current transformer**, 226.
- Cooling**, 158.
- Cores**, 153; joints in, 154.
- Core losses**, *see* Losses.
- Core type**, single-phase, 151, 157; three-phase, 272.
- Current**, exciting or no load, 182; magnetizing component of, 165, 166, 167, 182, 293; hysteresis and eddy-current component of, 165, 167, 182, 292; determination of wave form of components of no load, 174; load

STATIC TRANSFORMERS

- component of primary, 184; reaction of secondary, 183.
- Current rushes**, 176.
- Current transformer**, 222.
- Eddy currents**, losses due to, 200; screening effect of, 205.
- Efficiency**, 206, 295; all day, 209.
- Electromotive force**, induced, 164, shape of wave from flux curve, 173.
- Equivalent circuit**, 195, 197; calculation of regulation from, 198.
- Flux**, concerned in operation of a transformer, 179; mutual, 179; leakage, 179, 187; determination of wave shape of, 169; wave forms of flux and e.m.f., 171.
- Harmonics**, relative magnitudes of, in flux and electromotive force, 171; in exciting current of single-phase transformer, 176; with T connection, 263; in exciting currents and voltages of single-phase transformers connected three-phase, 276; in exciting currents and voltages of three-phase transformers, 279.
- Hysteresis loss**, 202.
- Induction regulator**, 238, 454.
- Insulation of coils**, 155.
- Losses**, 200; eddy current, 200, 205; hysteresis, 202; measurement of core, 213; separation of eddy current and hysteresis, 214; relative values of, for maximum efficiency, 208.
- Lamination of core**, thinness of, 153; insulation of laminae, 153.
- Leakage**, magnetic, 179; flux, 179, 187.
- Mutual flux**, 179.
- Oil**, 162.
- Opposition test**, 218.
- Parallel operation**, single-phase, 243; three-phase, 283; of V and Δ systems, 286.

STATIC TRANSFORMERS

- Potential transformer, 225.
 Radiation, from cases, 160.
 Ratio of transformation, 183.
 Reactance, leakage, 180; calculation of, 188, 291; equivalent, 196, 291, 294; relative values of primary and secondary, 186; measurement of, 217, 218.
 Reactance coil, 166.
 Reduction factors, 184.
 Regulation, calculation of, from vector diagram, 192; from approximate equivalent circuit, 198, 295.
 Resistance, relative values primary and secondary, 186; equivalent, 196, 294; measurement of equivalent, 216.
 Secondary, reaction of, 183; two independently loaded secondaries, 241.
 Shell type, single-phase, 151, 157; three-phase, 274.
 Steinmetz, exponent, 204.
 Tanks, *see* Cases.
 Terminals, bushings for, 158; condenser, 157; oil filled, 157.
 Three-phase transformers, core-type, 272; shell-type, 274; harmonics in exciting current and voltages, 279; advantages and disadvantages, 282.
 Transformer, 151; on open circuit, 165; on closed circuit, 183.
 Types, 151, 157; three-phase, 272, 274.
 Vector diagram, no load, 181; load, 190; of reactance coil, 166; analysis of, 191; solution of, 192; approximate, 197.
 Voltage, induced, 164, 180, 182.
 Wave form, of exciting current, 176; of voltage from three-phase connections, 276; distortion by T connection, 263.
 Windings, 155.

SYNCHRONOUS MOTORS,

pp. 297-340

- Advantages, 338
 Air gap, effect on stiffness of coupling, 321; effect on starting, 325; effect on damping, 321.
 Amortisseur, 318, 319.
 Armature reaction, *see* Reaction.
 Characteristics, operating, 297.
 Circle diagram, 330; proof of, 330; construction of, 333; limiting operating conditions from, 335; uses of, 336.
 Compounding curves, 298, 307, 337.
 Construction, 297.
 Coupling, stiffness of, 321; effect of leakage reactance and air gap on, 321.
 Damping, 318.
 Damper, 299, 318, 319.
 Disadvantages, 338.
 Efficiency, 338.
 Excitation, normal, 298; over and under, 298; change in normal with load, 306; maximum and minimum, 309, 313, 335; effect of change in, 307.
 Flywheel, for damping, 318, 319.
 Hunting, 314; period of, 317; damping, 318.
 Lag of current, effect of, 302.
 Lead of current, effect of, 302.
 Limiting conditions of operation, maximum and minimum excitation, 309, 313, 335; maximum power, 311, 313, 336; minimum power factor, 335.
 Losses, 338.
 Load, effect of a change in, 307.
 Magnetomotive force, vector diagram, 306.
 Operation, explanation of, 299.
 Power, equation of, 310; maximum, 311, 313, 336; phase displacement of motor electromotive for maximum, 318.

SYNCHRONOUS MOTORS

- Power factor**, 297; minimum, 335.
Reactance, leakage, effect on stiffness of coupling, 321.
Reaction, armature, 300, 302, 319, 320, 326.
Speed, 297.
Stability, 322, 325, 336; stability factor, 323.
Starting, methods of, 299, 325.
Stiffness of coupling, 321, 325.
Synchr nous impedance, vector diagram, 306.
Torque, 300, 301, 302; starting, 327.
V-curves, 298, 336.
Voltage, induced in field winding while starting, 328.
Uses, 339.
Vector diagram, 304; solution of, 305; magnetomotive force, 306; synchronous impedance, 306.
Winding, *see* Construction; damping, 318, 319.

PARALLEL OPERATION OF ALTERNATORS, pp. 341-392

- Alternators**, in parallel, 341, 343; current delivered by each, 344, 345, 346, 348; current delivered by system, 344.
Amortisseur, 363.
Batteries in parallel, 342.
Constants of alternators, for parallel operation, 350, 352, 382.
Circulatory current, 345, 346, 350; produced by unequal excitation, 370; produced by difference in phase, 372.
Coefficient, of governor insensitiveness, 368.
Connections, for parallel operation, 384, 387, 390.
Current, circulatory, 345, 346, 350; circulatory, produced by unequal excitation, 370; circulatory produced by difference in phase, 372; delivered by each

PARALLEL OPERATION OF ALTERNATORS

- alternator, 344, 345, 346, 348; delivered by system, 344, 349.
Cyclic irregularity, of engine speed, 368.
Damper, 362, construction of, *see* Synchronous motors.
Damping, 362, 366.
Difference between alternators and d.-c. generators in parallel, 383.
Engine, irregularity of torque, 363; characteristics of, for parallel operation, 375, 382; effect of slope of speed-load curve, 374.
Excitation, effect of change, 370, 383.
General statements, regarding parallel operation, 341.
Governors, 367; coefficient of insensitiveness, 368; effect of changing tension of spring, 376.
Hunting, 361; period of, 362; damping, 362.
Harmonics, effect of, 377; third, in neutral, 379.
Impedance, effect of paralleling through high, 359.
Interchange current, *see* Circulatory current.
Irregularity, of engine torque, 363; cyclic irregularity, 368.
Lincoln synchronizer, 390.
Load, method of adjusting, 373, 376; effect of field excitation on, 370.
Reactance, necessity for, 349.
Synchronizing, action, two equal alternators, 346, 349, 353; current, 349.
Synchronizing, devices, 384; period of voltage on devices, 385; transformer, 386; lamps, 387; Siemens & Halske arrangement of lamps for, 388; Lincoln synchronizer, 390.
Synchronizing power, 356; with fixed excitation, 357; with fixed terminal voltage, 358, 365;

**PARALLEL OPERATION OF
ALTERNATORS**

- effect on, of short-circuit, 357;
effect on, of increasing r or z , 358;
effect on, of paralleling through
highimpedance, 359; relation be-
tween r and z for maximum, 360.
Torque engine, irregularity of, 363.
Voltage, variation in phase of ter-
minal voltage caused by hunt-
ing, 356.
Wave form, effect of, 377; effect
of third harmonic in, with
grounded neutrals, 379.

**SYNCHRONOUS CONVERTERS,
pp. 393-442**

- Amortisseur, *see* Damping bridges.
Armature reaction, 414.
Calculation, of field excitation and
efficiency, 437.
Converter, *see* Rotary converter.
Commutating poles, 417.
Copper loss, 403; inductor heating,
403; calculation of, 406; table of
ratio of maximum to minimum
inductor heating, 407; curves
of inductor copper loss, 408.
Current, relative values of a.c. and
d.c., 400; table of ratios of a.c.
and d.c., 402.
Damper or damping bridges, 418,
420, 431.
Damping, 418, 431.
Double-current generator, 430.
Efficiency, 411, 440.
Flash-over, 421a.
Heating, *see* Copper loss.
Hunting, 417; sparking caused by,
418, 419; effect on armature
reaction, 418.
Inductor heating, 403; table of, 407.
Inverted converter, 429.
Mechanical rectifiers, 393.
Mercury arc rectifiers, 393.
Methods of converting a.c. to d.c.,
393.
Motor generators, 394; versus rotary
converters, 432.

SYNCHRONOUS CONVERTERS

- Output, relative of converters as
converter and as generator, 408;
table of relative outputs, 409;
plots of relative outputs, 410,
411.
Parallel operation, 435.
Poles, commutating, 417; split, 425.
Rotary converter, 394; direct, 394; in-
verted, 394, 429; split-pole,
425.
Reaction, armature, 414.
Sixty-cycle converter, 430.
Split-pole converter, 425.
Starting, methods of, 419.
Transformer connections, 422, 428.
Voltage, induced, 395, 396.
Voltage control, 423, by synchron-
ous booster, 424; by induction
regulator, 424; by series react-
ance, 425; by split-pole, 425.
Voltage ratio, 396; table of, 398.

**POLYPHASE INDUCTION
MOTORS, pp. 443-510**

- Air gap, effect of slots on, 468;
necessity for small, 465.
Asynchronous machines, 443.
Breakdown torque, *see* Torque, max-
imum.
Calculation of performance, from
equivalent circuit, 484, 505;
from circle diagram, 490.
Circle diagram, 490; proof of, 490;
scales for, 494; determination
of, 495.
Concatenation, 477; speed in, 479;
division of power in, 480; losses
in, 482.
Current, starting, 471, 473.
Diagram, transformer vector, 452;
analysis of, 460; circle, 490.
Efficiency, 486, 494, 510.
Equivalent circuit, 452; calculation
of performance from, 484, 505.
Field, revolving, 444, 446; *see* Flux.
Flux, 446; harmonics in, and their
effect, 455; *see* Field.

POLYPHASE INDUCTION MOTORS

- Fractional-pitch windings**, 467.
- Generator, induction**, general characteristics of, 497; circle diagram of, 498; effect of change in slip of, 498; power factor of, 499; phase of rotor current referred to stator, 499; vector diagram of, 501; in parallel with synchronous apparatus, 501, 502; in parallel with condenser, 502; voltage, frequency and load of, 502; short-circuit current of, 503; hunting of, 503; advantages and disadvantages of, 503; uses of, 504.
- Harmonics**, effect of, in flux, 455.
- Load**, equivalent to a non-inductive resistance, 451.
- Losses**, 487, 488, 507.
- Polyphase induction motor**, 444; operation of, 444; revolving field of, 446; equivalent to a transformer, 448, 451.
- Polyphase induction regulator**, 454.
- Power**, 452; from equivalent circuit, 486; from circle diagram, 493; in concatenation, 480, 482; maximum, 494.
- Power factor**, 494; at starting, 471.
- Reactance**, effect of, on break-down torque, 464.
- Resistance**, of rotor, 488; of stator, 488; effect of, on maximum torque and slip at maximum torque, 464; effect of, on starting torque, 466, 467, effect of, on slip, 466; effect of shape of slots on, 467*a*.
- Revolving magnetic field**, 444, 446; effect of harmonics in, 455.
- Rotor**, reaction of current on stator, 448; coil wound, 468; squirrel cage, 469; advantages and disadvantages of two types of, 470.
- Slip**, 445; at maximum torque, 464; effect of shape of rotor slots on, 467*a*; proportional to rotor copper loss, 475.

POLYPHASE INDUCTION MOTORS

- Slots**, effect of shape of, on starting torque, 467*a*, relative numbers of, in rotor and stator, 468.
- Stability**, 464.
- Starting**, methods of, 471; torque, 465, 472; current, 471, 473; power factor, 471.
- Speed**, methods of varying, 474; by resistance, 474; by changing poles, 476; by varying frequency, 477; by concatenation, 477; speed-torque curve, 465.
- Torque**, internal, 461; effect of harmonics in flux on, 459; maximum, 464, 494; break-down, *see* Maximum; effect of resistance, reactance, voltage and frequency on break-down, 464; starting, 466; starting, proportional to rotor copper loss, 466, 472; effect of shape of rotor slots on starting, 467*a*.
- Vector diagram**, 452; analysis of, 460.
- Windings**, 444; fractional pitch, 467.

SINGLE-PHASE INDUCTION MOTORS, pp. 511-554

- Armatures**, *see* Rotors.
- Brushes**, number required for commutator motor, 533; commutation at brushes, 542.
- Clutch**, use of, to increase starting torque and diminish starting current, 548.
- Characteristics**, 511.
- Construction**, *see* Windings.
- Commutation**, of commutator type of motor, 542.
- Commutator type of motor**, 533.
- Converter**, induction motor as, 551.
- Currents**, components of rotor, 517, 518, 519, 522; components of stator, 530.
- Efficiency**, *see* Losses.
- Electromotive forces**, induced in

- SINGLE-PHASE INDUCTION MOTORS**
 rotor, 516, 517, 518; axis of rotor for e.m.f.s., 517, 518; phase of, with respect to flux, 527.
- Field**, quadrature, 516, 518; relative magnitudes of component fields, 520; revolving, 520.
- Ferraris**, method of explaining operation, 512.
- Generator action of motor**, 523, 532; motor generator action, 522.
- Losses**, comparison of, in single and polyphase motors, 523.
- Magnetic axis of rotor**, squirrel-cage type, 517, 518; drum type, 533.
- Magnetizing current**, for quadrature field, 518, 522, 525; of stator, 526; for quadrature field in stator, 530.
- Operation**, explanation of, 521.
- Output**, relative of single-phase and polyphase motors, 526.
- Phase converter**, 551; transforming from one to three phase, 553.
- Power factor**, of single and polyphase motors, 526; compensation for, 534.
- Quadrature field**, 516; magnetizing current for, 518, 522, 525, 530.
- Revolving field**, 520; shape of, 521.
- Rotation**, direction of, 511.
- Rotor**, squirrel-cage type, 512; drum type, 533; drum type equivalent to squirrel-cage type, 534.
- Slip**, 515, 532.
- Speed**, 514, 530; control of, with commutator-type of motor 538.
- Speed electromotive force**, 517, 518; phase of, with respect to flux, 527.
- Starting**, methods of, 545; by split phase, 545; by shading coils, 549; by phase converter, 549; by repulsion-motor action, 530; clutch, use of, 548.
- Torque**, starting, 511, 513, 514, 548; curve of, 512; effect on, of add-
- SINGLE-PHASE INDUCTION MOTORS**
 ing resistance to rotor, 515; condition for the production of, 521.
- Vector diagram**, for uncompensated motor at synchronous speed, 527, below synchronous speed, 530; for compensated motor, 535, 537.
- Voltage**, speed, *see* Speed voltage; *see* Electromotive forces.
- Windings**, 511.
- Weight**, relative of single- and polyphase motors, 511, 526.
- SERIES AND REPULSION MOTORS**, pp. 555-603
- Advantages and disadvantages**, of compensated repulsion motor, 594; of doubly fed series and repulsion motors, 601.
- Air gap**, of series motor, 562; of repulsion motor, 571.
- Commutation**, 555; of singly fed series motor, 566; resistance leads, 566; inductances, 568; of doubly fed series motor, 598; of singly fed repulsion motor, 577; best for repulsion motor at synchronous speed, 580; improved while starting by resistance in armature circuit, 580; of compensated repulsion motor, 588; of doubly fed repulsion motor, 602.
- Commutator**, necessity for many segments with series motor, 567.
- Commutator motors**, with series characteristics, 555.
- Comparison**, of singly fed series and repulsion motors, 581; of doubly fed series and repulsion motors, 601.
- Compensating winding**, 555; of series motor, 561, 562.
- Compensation**, 558; of series motor, 561; conductive, 562; inductive, 562; effect of over and under,

SERIES AND REPULSION MOTORS

565; of singly fed repulsion motor, 582, 586; of doubly fed repulsion motor, 602.

Component fields, of repulsion motor, 571; relative magnitudes of, 572, 577; of compensated repulsion motor, their relative magnitudes, 585, 587, 588, 589; of doubly fed repulsion motor, their relative magnitudes, 599, 602; of doubly fed series motor, their relative magnitudes, 597, 599.

Construction of series motors, 569; of repulsion motors, 571.

Differences, between series motors for a.-c. and d.-c. operation, 559.

Doubly fed repulsion motor, uncompensated, 556, 595, 599; compensated, 600; compensation, 602; commutation, 602; starting, 602; speed control 602; regeneration, 601, 603; advantages and disadvantages, 601.

Doubly fed series motor, 556, 596; approximate vector diagram, 597; commutation, 598; starting, 599; speed control, 597, 599; advantages and disadvantages, 601.

Efficiency, of series motors, 569.

Field, of series motor, 561, 569; *see* Component fields.

Frequency, necessity for low, 560.

Interpoles, use on singly fed series motors, 568.

Magnetic circuit, of series motor, 562; of repulsion motor, 571.

Power, internal, of a motor, 560.

Power factor, 558; lower for uncompensated repulsion motor than for series motor, 582; *see* Compensation.

Repulsion motors, *see* Singly fed repulsion motors and Doubly fed repulsion motors.

SERIES AND REPULSION MOTORS

Reactance, of series motor, 560.

Regeneration, by doubly fed compensated repulsion motor, 601, 603.

Relative strengths, of armature and field with series motor, 559.

Rotation, direction of, with singly fed repulsion motor, 572; with compensated repulsion motor, 593.

Resistance, leads to improve commutation of series motor, 566, 598; in armature of repulsion motor to improve commutation while starting, 580.

Series motors, *see* Singly fed series motors and Doubly fed series motors.

Singly fed repulsion motor, uncompensated, 555, 570; component fields, 571, 572; relative magnitude of component fields, 572, 577; necessity for non-salient poles, 571; torque and speed characteristics, 572; equivalent to a transformer in series with an impedance, 573, 574; equation for speed, 576; speed control, 572; vector diagram, 574; commutation, 577.

Singly fed repulsion motor, compensated, 583; diagram of connections, 584; relative magnitude of component fields, 585, 588; voltages in armature, 585; power factor compensation, 586; commutation, 588; vector diagram, 590; speed control and direction of rotation, 593.

Singly fed series motor, 555, 559; construction, 569; efficiency and losses, 569; starting, 556, 566; speed control, 566; compensation, 561, 566; compensating winding, 561, 562, 565; commutation, 566; relative

SERIES AND REPULSION MOTORS

- strengths of armature and field, 559; vector diagrams, 563, 564.
- Speed**, equation of, for singly fed repulsion motor, 576.
- Speed control**, *see* Starting and speed control.
- Starting and speed control**, 556; of singly fed series motor, 566; of doubly fed series motor, 597, 599; of singly fed repulsion motor, 572, 593; of doubly fed repulsion motor, 602.
- Torque**, of series motor, 559; effect on, of current in armature coils short circuited by brushes, 566.
- Types**, of commutator motors with series characteristics, 555.

SERIES AND REPULSION MOTORS

- Vector diagram**, of singly fed series motor, 563, 564; of singly fed repulsion motor, 574; of singly fed compensated repulsion motor, 590; of doubly fed series motor, 598.
- Voltage**, necessity for low, with series motor, 567.
- Voltages, induced**, in singly fed series motor, 560, 566; in doubly fed series motor, 595, 597, 598; in singly fed uncompensated repulsion motor, 571, 573, 577, 579, 580; in singly fed compensated repulsion motor, 585, 586, 587, 588, 589.
- Windings**, 555.
- Winter-Eichberg motor**, 584.